

GSA

Federal Supply Service
Authorized Federal Supply
Schedule Price List

FSC Group 71, Part I Office Furniture
FSC Class 7110
(Office, Conference Room,
and Reception Area Furniture)

Contract #GS-28F-0017R

Business Size: Small
Cage Code: 3XYJ1
DUNS #: 091675082

MARCH 22, 2005 - MARCH 21, 2010

On-Line access to contract ordering information, terms and conditions, up-to-date pricing, and the option to create an electronic delivery order are available through GSA Advantage!, a menu-driven database system. the INTERNET address GSA Advantage! is: GSAAdvantage.gov.

For more information on ordering from Federal Supply Schedules click on the FSS Schedules button at fss.gsa.gov.



INTERNATIONAL

200 Lehigh St.
Geneva, NY 14456
315-789-4400
Fax 315-789-0376
email: gsa@ccnintl.com
www.ccnintl.com

contents

GSA Program General Information	3
About CCN	4
Barrington	5
Charisma	7
Solon	9
Foundation	11
Tocotta	13
Crofton	15
Gallery Desks	17
Tables	19
Accessories	21

GSA Program General Information

Intended use: The furniture covered by Special Item Numbers 711-8, 711-9, and 711-10 is intended for use by Government executive (or equivalent military rank) in the Executive, Judicial, and Legislative Branches, or Armed Forces of the Federal Government. The ordering agency or service is responsible for determining furniture appropriate for use in its offices which will fit within its budget and comply with applicable Federal or international agency procurement regulations.

To help customers make a good purchasing decision based on their needs and budget. GSA has established five grades of furniture. Grade (1) includes furniture that tends to be the most expensive on this schedule, Grade (2) furniture tends to be more moderately priced and Grades (3), (4) and (5) furniture tend to be affordably priced when compared to Grades (1) and (2). Some pieces of furniture on this schedule may be significantly higher in price than GSA Traditional and Contemporary Executive Special Order Program furniture. The ordering agency or service is responsible for determining furniture appropriate for use in its offices which will fit within its budget and comply with applicable Federal or internal agency procurement regulations.

Definition of Grades

Grade (1)

All exposed solid parts such as top rims, base rails etc. (except decorative accents, inlays and parts) shall be the same specials as the face veneer. Top and bottom edges of drawer fronts shall be solid wood in the same species as the face veneers. Drawer sides and backs shall be solid wood. All CCN products classify as Grade (1).

1a. Award Special Item Numbers:

- 711-8 Executive Wood Furniture
- 711-9 Executive Conference Room Furniture
- 711-10 Wood Furniture Single item accent
- 711-11 Tables & Accessories
- 711-95 Installation Services

1b. Lowest priced model for each Special Item Number:

- 711-8 _SBU11-153029 Bookcase \$978.00L
- 711-9 _TS1C0LG-4242 Square Conference Table w/Cube Base \$1586.00L
- 711-10 _TD-202018 Occasional Drum Table \$824.00L
- 711-11 AMWB-CAP Wall Mount End Cap \$38.00L

2. Order Limitation: Maximum order \$500,000.00. (if order exceeds this amount Government Client should negotiate further concessions with vendor.) All orders shall be as for one destination.

3. Minimum Order: \$100.00

4. Geographic Coverage: 48 Contiguous States and the District of Columbia. shipment for Alaska, Hawaii, Puerto Rico etc. are F.O.B. point of embarkation.

5. Production Point: Geneva, Ontario County, New York

6. Discount: 55% off of price list dated March, 2004.

CALL CUSTOMER SERVICE FOR DISCOUNT THAT WOULD APPLY TO YOUR ORDER.

7. Quantity Discounts NONE

8. Prompt Payment Discount: Net 30 days.

9a. Government Commercial Credit Card is accepted below the micropurchase threshold. (with no additional discounts).

Written confirmations with authorized signature required.

Card must be used at time of order placement with cash changed at time of shipment or performance.

9b. Government Commercial Credit Cards will be accepted above the micro-purchase threshold.

10. All items assembled in U.S.A.

11a. Time of Delivery: 70 days after receipt of order, or less. Orders which require delivery dates in excess of 70 days shall specify a (...do not ship until...) instruction.

11b. Expedited Delivery: N/A

11c. Overnight and 2-day Delivery: N/A

12. FOB: Origin - freight prepaid - For freight rate, please contact CCN Customer Service at 315.789.4400.

13a. Ordering Address: CCN International
200 Lehigh Street
Geneva, New York 14456
Fax: 315-789-0376
Email: gsa@ccnintl.com

14. Payment address: Same as #13 above.

15. Standard Commercial Warranty: See Commercial price lists for additional warranty information.

16. Export Packing Charges: Quoted upon request.

17. Government credit cards accepted for payment.

18. Terms and Conditions of rental, maintenance and repair: N/A

19. Terms and Conditions of installation: Installation fees for SIN #711-95 will be charged separately on a per job basis.

Industrial Funding Fee: 1% should be added to any installation amount that is included on a Government Purchase Order to CCN International.

CCN International pays the fee to The General Services Administration quarterly.

20. Terms and Conditions of repair parts: available on request

21. List of service and distribution points: Contact factory

22. List of participating dealers: Contact customer service for dealer listing.

23. Preventative maintenance: Contact factory

24a. Environmental attributes: CCN is an FSC certified supplier. FSC certified products are available at an upcharge. Contact CCN customer service for further information.

25. Data Universal Number System (DUNS) number: 091675082

26. Central Contract Registration Number: 3XYJ1

About CCN

Founded in 1985, CCN merged the talents of partners with a strong foundation in custom/OEM manufacturing and sales/marketing expertise. Concentrating on the manufacture of wood casegoods for corporate and institutional environments, CCN has developed a solid reputation for both innovation and quality.

Headquartered in the heart of Upstate New York's Finger Lakes region, CCN benefits from the area's heritage of fine woodworking, having been a center for both the American Arts and Crafts movement in the early 1900's and a mecca for the Studio Arts in the 60's and 70's. CCN's manufacturing facility merges state of the art computer controlled machinery with time honored hand craftsmanship, taking full advantage of the best each has to offer.

Long respected for the quality and manner in which wood veneer panels are implemented in their furniture, CCN hand selects the highest quality veneers and lays them up in house to ensure the finest results. CCN approaches all orders on a per-project basis, selecting materials specifically for that project, then making certain that all veneer panels are not only sequenced, centered and balanced for each individual piece of furniture, but sequenced and matching for the complete order, whether it be one room or fifty.

This expertise in the execution of veneers is complemented by a similar attention to high quality construction, craftsmanship of solid wood elements, state of the art finishes, the integration of other material such as metal or stone, and the ability to accommodate office technology via wiring solutions, video lifts, key-less locking, etcetera. Accommodating modifications to standard product has been an integral part of the CCN success strategy from day one.

This overview Price List provides a glimpse of CCN's product scope and capabilities. All product categories are more thoroughly presented in the full CCN binder which includes full scope price lists and more extensive brochures on individual products. For more on the full breadth of CCN's offerings, information regarding discounts or for product modification inquiries, contact your local CCN representative, our customer service group at 315-789-4400, or visit us on the web at www.ccnintl.com.

Description	Model Number(s)	D	W	H	Price (US\$)		Weight
					Standard	££	(lbs.)

Hi-Rise Display Credenza and Table Desk

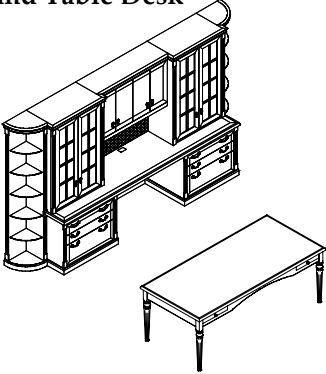

Credenza Configuration
GXL003-2615477-UU

25½ 153½ 77 26709 30134 1316

Table Desk

GTS4A-3072 -0-DR2

30 72 29 3784 4667 133

GTS4A-3672 -0-DR2

36 72 29 3993 5012 149

GTS4A-3678 -0-DR2

36 78 29 4158 5253 158

GTS4A-4284 -0-DR2

42 84 29 4562 5887 186

Executive "U" Configuration Desk/Bridge/Hi-Rise Credenza

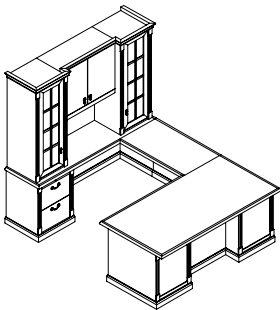

Configuration
GXDL01-997877-CD

98½ 78 77 20587 25228 982

Round Conference Table with Cabriole Column Base

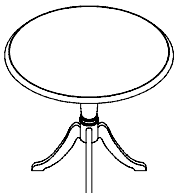

GTR1Y-3636

36 36 29 2636 3269 65

GTR1Y-4242

42 42 29 3084 3882 91

GTR1Y-4848

48 48 29 3888 4891 111

Prices reflect standard CCN cherry or maple finishes

BARRINGTON

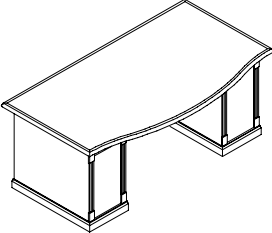
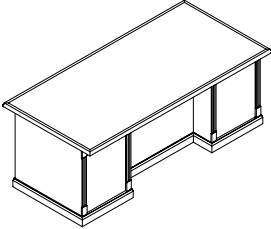
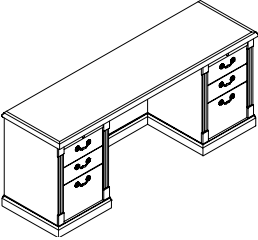
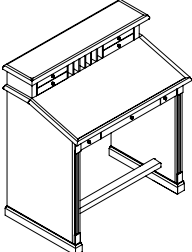
Description	Model Number(s)	D	W	H	Price (US\$)		Weight (lbs.)
					Standard	££	
Table Desk w/ Tulip Top							
	GDTT-3966-PP	39¼	66	29	7046	9009	199
	GDTT-4072-PP	39¼	72	29	7199	9304	212
	GDTT-4378-PP	42½	78	29	7397	9692	230
	GDTT-4384-PP	43¼	84	29	7516	9934	241
	GDTT-4378-AB	42½	78	29	7287	9691	300
	GDTT-4384-AB	43¼	84	29	7408	9933	311
Double Pedestal Desk							
	GD0-3672-AB	36	72	29	7023	9580	294
	GD0-3678-CD	36	78	29	7144	9846	305
	GD0-3684-CD	36	84	29	7269	10110	316
Double Pedestal Kneespace Credenza							
	GC0-2172-AA	20½	72	29	5875	7066	256
	GC0-2178-CC	20½	78	29	5974	7246	264
	GC0-2184-CC	20½	84	29	6074	7371	272
	GC0-2196-CC	20½	96	29	6276	7674	288
	GC0-2672-AA	25½	72	29	5997	7301	269
	GC0-2678-CC	25½	78	29	6102	7465	278
	GC0-2684-AA	25½	84	29	6203	7620	287
	GC0-2696-CC	25½	96	29	6409	7955	305
Stand-Up Desk							
	GDI-3348	33	48	52	5621	6286	191
	GDI-3354	33	54	52	5885	6621	214

Also see page 32 for Barrington Gallery Desks
and pages 34-37 for Barrington Tables

BARRINGTON

For more extensive product offering
consult the complete Barrington price list.

Description	Model Number(s)	D	W	H	Price (US\$)		Weight
					Standard	££	(lbs.)

Hi-Rise Credenza Configuration and Bow Front Desk

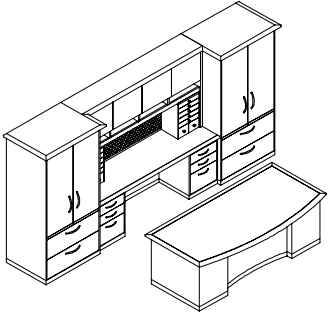

Credenza Configuration
CXJ001-2814476-AA

28 144 76 26601 28118 1514

Desk:

CDDB-4278-CD

42 78 29 7769 8851 321

CDDB-4284-CD

42 84 29 7950 9059 333

Executive "U" Configuration

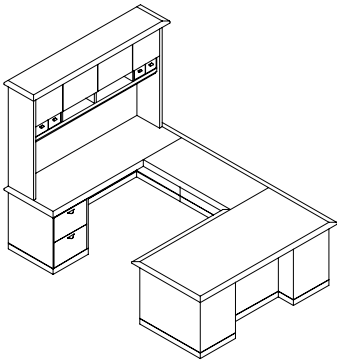

Configuration:
CXDL01-1043476-AD

104 84 76 17040 19335 839

Oval Table Desk



CT016-3472

33½ 72 29 7815 8489 150

CT016-3678

36¼ 78 29 8198 8924 163

CT016-3984

39 84 29 8650 9433 179

Prices reflect standard CCN cherry or maple finishes

CHARISMA

Description	Model Number(s)	D	W	H	Price (US\$)		Weight (lbs.)
					Standard	££	

Double Pedestal Desk

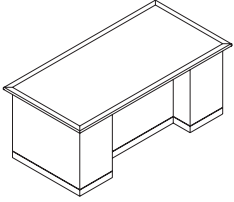

CD0-3066-AB	30	66	29	6100	6817	269
CD0-3072-AB	30	72	29	6232	6988	279
CD0-3672-AB	36	72	29	6388	7185	294
CD0-3678-CD	36	78	29	6545	7348	305
CD0-3684-CD	36	84	29	6634	7510	316

Double Pedestal Kneespace Credenza

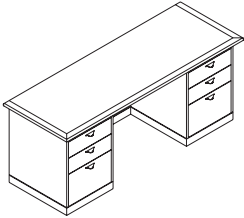

CC0-2166-AA	21	66	29	5632	6120	248
CC0-2172-AA	21	72	29	5740	6256	256
CC0-2178-CC	21	78	29	5840	6382	264
CC0-2184-CC	21	84	29	5938	6508	272
CC0-2666-AA	26	66	29	5753	6275	259
CC0-2672-AA	26	72	29	5865	6413	269
CC0-2678-CC	26	78	29	5968	6545	278
CC0-2684-CC	26	84	29	6069	6674	287

Medium Profile Hi-Rise Storage

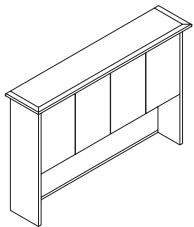

CSUH21-1666	16	66	47	4121	4692	227
CSUH21-1672	16	72	47	4252	4857	243
CSUH21-1678	16	78	47	4362	5004	259
CSUH21-1684	16	84	47	4471	5147	275

Wardrobe-Shelving Storage Full Wardrobe Storage

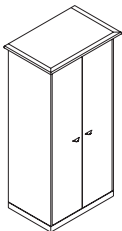

1 side wardrobe/1side shelving							
CSD025-283476	28	34	76	6277	6399	418	
CSD025-284076	28	40	76	6449	6779	463	
full wardrobe							
CSC011-283476	28	34	76	4443	4565	294	
CSC011-284076	28	40	76	4739	4869	325	

See page 31 for Charisma Gallery Desks
and pages 34-37 for Charisma Conference Tables

CHARISMA

For more extensive product offering
consult the complete Charisma price list.

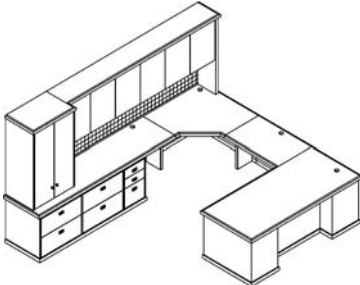
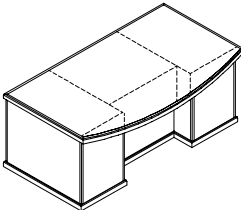
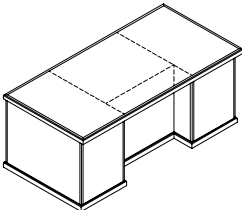
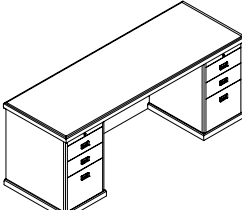
Description	Model Number(s)	D	W	H	Price (US\$) Standard	Weight (lbs.)
Executive "U" Configuration	Configuration: SXXL02-11413876-CAEE	114	138	76	29595	1622
						
Bowtop Double Pedestal Desk	SDB-4072-AB	40	72	29	6580	304
	SDB-4178-CD	41	78	29	6738	318
	SDB-4284-CD	42	84	29	6900	333
Double Pedestal Desk	SD0-3066-AB	30	66	29	5861	269
	SD0-3072-CD	30	72	29	5984	279
	SD0-3672-CD	36	72	29	6137	294
	SD0-3678-CD	36	78	29	6255	305
	SD0-3684-CD	36	84	29	6370	316
Double Pedestal Kneespace Credenza	SC0-2066-AA	20	66	29½	5399	246
	SC0-2072-CC	20	72	29½	5499	254
	SC0-2078-CC	20	78	29½	5594	261
	SC0-2084-CC	20	84	29½	5682	269
	SC0-2566-AA	25	66	29½	5513	257
	SC0-2572-CC	25	72	29½	5618	266
	SC0-2578-CC	25	78	29½	5717	275
	SC0-2584-CC	25	84	29½	5812	284

Prices reflect standard CCN cherry or maple finishes

S O L O N

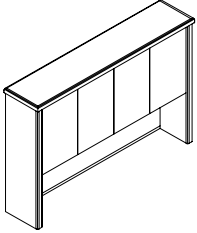
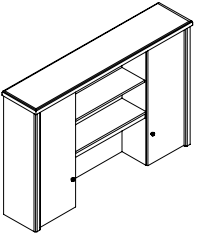
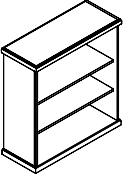
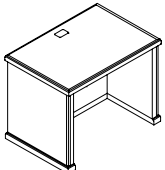
Description	Model Number(s)	D	W	H	Price (US\$) Standard	Weight (lbs.)
Medium Profile Hi-Rise Storage						
	SSUH21-1566	15	64	47	3923	219
	SSUH21-1572	15	70	47	4051	235
	SSUH21-1578	15	76	47	4158	250
	SSUH31-1584	15	82	47	4940	273
Split Door Hi-Rise Storage						
	SSUI331-1566	15	64	47	4780	293
	SSUI331-1566	15	70	47	4914	312
	SSUI331-1566	15	76	47	5030	331
	SSUI431-1566	15	82	47	5281	357
Single Bay Bookcase						
	SSB012-1431	13½	31	42½	1905	100
	SSB012-1437	13½	37	42½	1985	113
Computer Table						
	SM0-2030-0-GL1	20	30	29	2284	74
	SM0-2036-0-GL1	20	36	29	2382	81
	SM0-2042-0-GL1	20	42	29	2479	89
	SM0-2430-0-GL1	24	30	29	2437	87
	SM0-2436-0-GL1	24	36	29	2539	96
	SM0-2442-0-GL1	24	42	29	2641	105

Description	Model Number(s)	D	W	H	Price (US\$) Standard	Weight (lbs.)
-------------	-----------------	---	---	---	--------------------------	------------------

Workstation Configuration

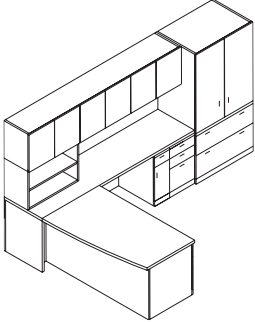

Configuration: _XUR01-729353-gC	84	132	70½	18688	1175
------------------------------------	----	-----	-----	-------	------

Workstation Configuration

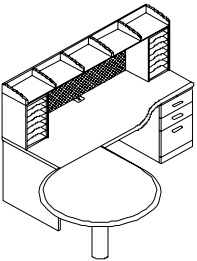

Configuration: _XTR01-729353-A	72	93	53	8902	389
-----------------------------------	----	----	----	------	-----

Bow Top Double Pedestal Desk

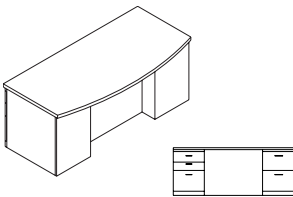

_DB00S-3672-CD	30/36	72	29¼	4807	292
_DB00S-3678-CD	30/36	78	29¼	4923	303
_DB00S-3684-CD	30/36	84	29¼	5044	314
_DB00S-4272-CD	36/42	72	29¼	5046	307
_DB00S-4278-CD	36/42	78	29¼	5169	319
_DB00S-4284-CD	36/42	84	29¼	5294	332

Double Pedestal Desk

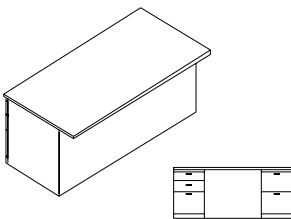

_D0-3072-CD	30	72	29¼	4087	277
_D0-3078-CD	30	78	29¼	4183	287
_D0-3084-CD	30	84	29¼	4283	297
_D0-3672-CD	36	72	29¼	4303	292
_D0-3678-CD	36	78	29¼	4409	303
_D0-3684-CD	36	84	29¼	4513	314

Prices reflect standard CCN cherry or maple finishes

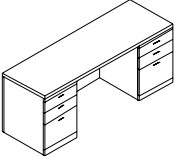
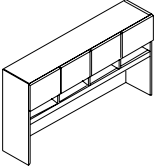
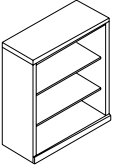
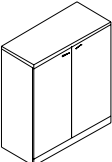

Description	Model Number(s)	D	W	H	Price (US\$) Standard	Weight (lbs.)	
Credenza							
	_C000L-2072-CKC	20	72	29¼	3770	252	
	_C000L-2078-CKC	20	78	29¼	3859	260	
	_C000L-2084-CKC	20	74	29¼	3947	267	
	_C000L-2090-CKC	20	90	29¼	4037	275	
	_C000L-2096-CKC	20	96	29¼	4128	283	
	_C000L-2472-CKC	24	72	29¼	3957	262	
	_C000L-2478-CKC	24	78	29¼	4050	271	
	_C000L-2484-CKC	24	84	29¼	4140	279	
	_C000L-2490-CKC	24	90	29¼	4234	288	
	_C000L-2496-CKC	24	96	29¼	4323	296	
Hinged Door Hi-Rise Storage with Organizer Below							
	xSUD20-1572	15	72	41¼	3354	188	
	xSUD20-1578	15	78	41¼	3434	202	
	xSUD30-1584	15	84	41¼	4192	220	
	xSUD30-1590	15	90	41¼	4275	233	
	xSUD30-1596	15	96	41¼	4354	246	
	xSUD21-1572	15	72	53¼	3913	258	
	xSUD21-1578	15	78	53¼	4017	276	
	xSUD31-1584	15	84	53¼	4914	303	
	xSUD31-1590	15	90	53¼	5021	321	
	xSUD31-1596	15	96	53¼	5125	339	
	Bookcase						
		_SBU12-153043	15	30	42¾	1350	98
		_SBU12-153643	15	36	42¾	1424	112
		_SBU13-153055	15	30	55	1581	122
_SBU13-153655		15	36	55	1672	139	
Hinged Door Storage							
	xSHU12-163043	16	30⅞	42¾	1989	112	
	xSHU12-163643	16	36⅞	42¾	2150	129	
	xSHU12-203043	20	30⅞	42¾	2129	134	
	xSHU12-203643	20	36⅞	42¾	2300	153	
	xSHU12-243043	24	30⅞	42¾	2266	155	
	xSHU12-243643	24	36⅞	42¾	2444	177	

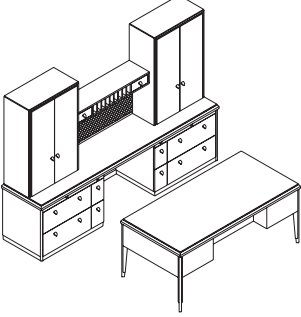
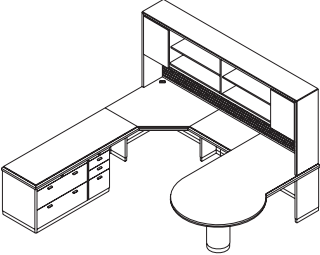
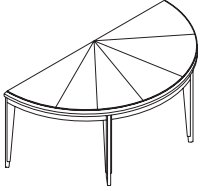
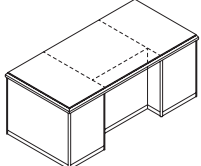
Description	Model Number(s)	D	W	H	Price (US\$) Standard	Weight (lbs.)
Hi-Rise Credenza Configuration and Medium Profile Desk:						
	Credenza Configuration TXH002-2010875-EaKaE[-TBF]	20	118	74¾	20732	971
	Desk:					
	TDTJ-3672	36	72	29¼	8439	267
	TDTJ-3678	36	78	29¼	8608	273
	TDTJ-3684	36	84	29¼	7767	280
Configuration overall dimension:						
	Configuration: TXXL01-11411077-CF -[GL1-TBF-TL6]	114	110	76½	23653	1077
Demi Lune Desk						
	TTL4L3SB-3672-0-DR2	72	36	29¼	8658	140
	TTL4L3SB-3978-0-DR2	78	39	29¼	9238	156
	TTL4L3SB-4284-0-DR2	84	42	29¼	9845	174
Double Pedestal Desk						
	TD0-3672-CD	72	36	29¼	8518	363
	TD0-3678-CD	78	36	29¼	8751	374
	TD0-3684-CD	84	36	29¼	8979	385

Prices reflect standard CCN cherry or maple finishes

T O C O T T A

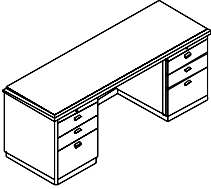
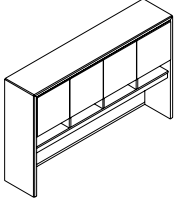
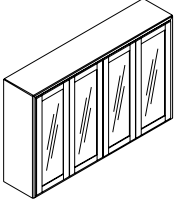
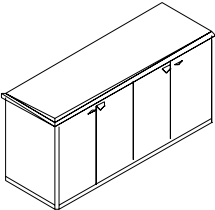
Description	Model Number(s)	D	W	H	Price (US\$) Standard	Weight (lbs.)
Double Pedestal Credenza						
	TC0-2072-CC	20	72	29¼	7007	322
	TC0-2078-CC	20	78	29¼	7077	330
	TC0-2084-CC	20	84	29¼	7374	339
	TC0-2572-CC	20	72	29¼	7220	346
	TC0-2578-CC	20	78	29¼	7404	355
	TC0-2584-CC	20	84	29¼	7591	365
Hi-Rise Storage with hinged doors & linear						
	TSUD20-1572	15	69⅝	45½	4773	242
	TSUD20-1578	15	75⅝	45½	4870	258
	TSUD20-1584	15	81⅝	45½	4967	274
Hi-Rise Storage with full glass doors						
	TSUT230G-1572	15	69⅝	45½	7980	397
	TSUT230G-1578	15	75⅝	45½	8151	425
	TSUT230G-1584	15	81⅝	45½	8325	453
Conference Credenza						
	TC0V-2072-HHHH	20	72	36	7096	311
	TC0V-2084-HHHH	20	84	36	7476	331
	TC0V-2096-HHHHHH	20	96	36	8987	371
	TC0V-2572-HHHH	25	72	36	7318	339
	TC0V-2584-HHHH	25	84	36	7708	360
	TC0V-2596-HHHHHH	25	96	36	9222	402

See page 32 for Tocotta Gallery Desks
and pages 34-37 for Tocotta Conference Tables

T O C O T T A

For more extensive product offering
consult the complete Tocotta price list.

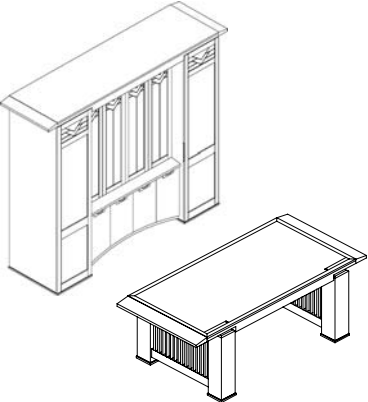
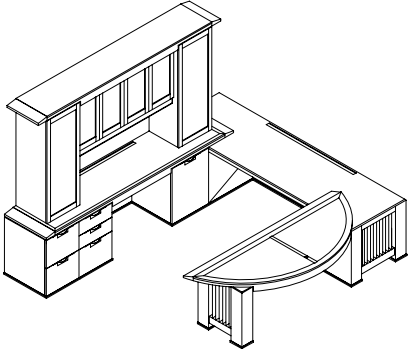
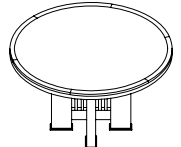
Description	Model Number(s)	D	W	H	Price (US\$) Standard	Weight (lbs.)
Full Storage Credenza and Table Desk 	Credenza:					
	FXJ001-2110584-HHHH-4A	21	105	84	30993	993
	FXJ001-2111784-HHHH-4A	21	117	84	31951	1064
	FXJ001-2112984-HHHH-4A	21	129	84	34283	1142
	Desk:					
	FDT-3872-0-OV2	37½	72	29½	11185	258
	FDT-3878-0-OV2	39½	78	29½	11458	277
FDT-4184-0-OV2	40	84	29½	11805	305	
U-Shape Workstation with Run-off Table and Hi-Rise Storage 	Configuration:					
	FXDL01-10511984-HCD-3A	105	119	84	47952	1487
Round Conference Table 	FTR1W-4848	48	48	29½	7195	174
	FTR1W-5454	54	54	29½	8012	222
	FTR1W-6060	60	60	29½	8926	274

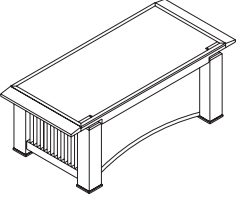
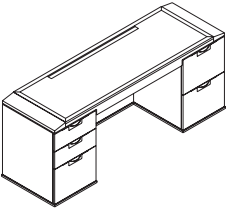
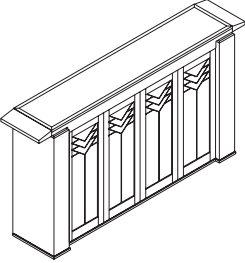
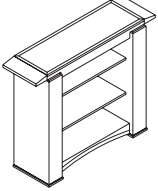
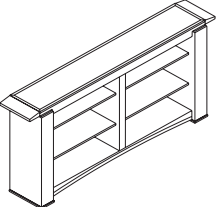

Description	Model Number(s)	W	D	H	Price (US\$) Standard	Weight (lbs.)
Double Pedestal Desk						
	FD0-4184-AB-OU2	84	41	29½	15883	527
	FD0-4390-AB-OU2	90	20	29½	16317	561
Kneespace Credenza						
	FC0-2472-CKD-PWC	72	24	29½	8920	326
	FC0-2478-CKD-PWC	78	24	29½	9223	341
	FC0-2484-CKD-PWC	84	24	29½	9527	357
Bookcase w/Glass Doors						
	FSG022-168144	81	16	44	12901	368
	FSG022-169344	93	16	44	14435	411
Open Bookcase						
	FSBQ12-165044	50	16	44	5753	210
	FSBQ12-165644	50	16	44	6061	226
	FSBQ22-168144	81	16	44	8164	324
	FSBQ22-169344	93	16	44	8776	357

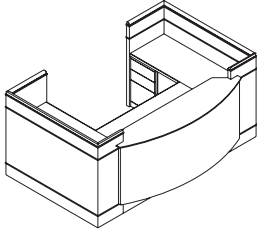
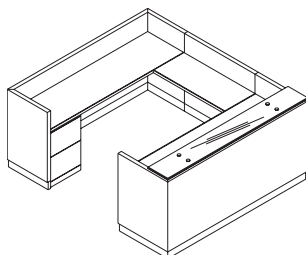
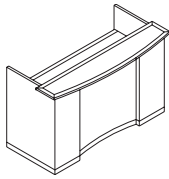
Description	Model Number(s)	W	D	H	Price (US\$) Standard	Weight (lbs.)
Prima Vista Gallery Desk						
"U" Configuration Rear Entry						
	VGM-7286-CD-GL4 Return tops: 21¾" x 35" Desk top: 23" x 82"	86	72	46	20375	918
	VGM-72100-CD-GL4 Return tops: 21¾" x 35" Desk top: 23" x 96"	100	72	46	21034	954
Specify Left or Right						
note: side entry "U", single return, and no return versions also available						
Kubit Gallery Desk						
"U" Configuration Side Entry						
	KGCL-10272-DC-GL4 Desk top: 27¾" x 68" Bridge top: 19" x 46" Credenza top: 24" x 68"	72	102	42	18031	761
	KGCL-10284-DC-GL4 overall dimension Desk top: 27¾" x 80" Bridge top: 24" x 46" Credenza top: 24" x 80"	84	102	42	19031	833
Specify Left or Right						
note: rear entry "U", single return, and no return versions also available						
Charisma Concave Stepped Modesty						
Gallery Desk w/Return						
	CGALD-7772-CD-GL3 Desk top: 24" x 65½" Return top: 22½" x 40¾"	72	76½	42½	12292	632
	CGALD-7784-CD-GL3 Desk top: 24" x 77½" Return top: 22½" x 40¾"	84	76½	42½	12659	676
Specify Left or Right (seated)						
note: rear entry "U", side entry "U", and single 1return versions also available.						

Prices reflect standard CCN cherry or maple finishes

GALLERY DESKS

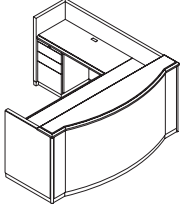
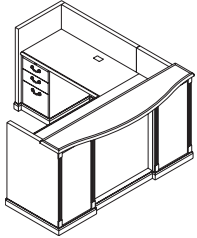
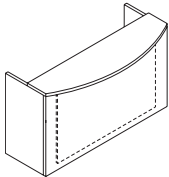
Description	Model Number(s)	W	D	H	Price (US\$) Standard	Weight (lbs.)
Tocotta						
Gallery Desk w/Return						
	TGAL-7872-CD-GL3 Desk top: 28" x 68" Return top: 22" x 40"	72 ³ / ₄	78	43	17191	732
	TGAL-7984-CD-GL3 Desk top: 28" x 80" Return top: 22" x 40"	84 ³ / ₄	78 ³ / ₄	43	18068	776
Specify Left or Right (Left indicated)						
note: rear entry "U", side entry "U", and no return versions also available						
Barrington						
Gallery Desk w/Return						
	GGAL-7772-CD-GL3 Desk top: 27" x 66" Return top: 22" x 40"	72	77 ¹ / ₄	42 ¹ / ₂	12410	589
	GGAL-7984-CD-GL3 Desk top: 27" x 78" Return top: 22" x 40"	84	78 ³ / ₄	42 ¹ / ₂	12866	637
Specify Left or Right (Left indicated)						
note: rear entry "U", side entry "U", and no return versions also available						
Foundation						
Gallery Desk						
	D0RT-3072-AB-GL2 Desk top: 28 ¹ / ₂ " x 69"	30	72	42 ³ / ₄	6291	451
	D0RT-3084-CD-GL2 Desk top: 28 ¹ / ₂ " x 81"	30	84	42 ³ / ₄	6566	485
Optional Feature Front: IWFI-15838 Vertical grain cherry or maple IWFI-16438 Vertical grain cherry or maple IWFIII-15838 Reverse box pattern birdseye maple IWFIII-16438 Reverse box pattern birdseye maple						
note: rear entry "U", side entry "U", and single return versions also available specify edge profile a,g,m,q,r , or s (see page 19)						

GALLERY DESKS

For more extensive product offering
consult the complete Reception Furnishings
and Gallery Workstations price list

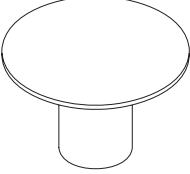
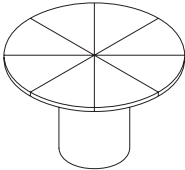
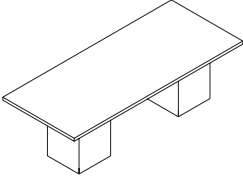
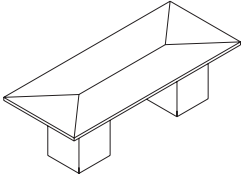
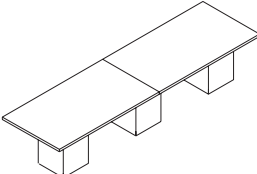
Description	Model Number(s)	W	D	H	Barrington	Charisma	Tocotta	Weight
Round w/drum base w/straight grain top 	xTR1D0LG-4242	42	42	29	3357*	3282	3457	149
	xTR1D0LG-4848	48	48	29	4178*	4104	4492	176
	xTR1D0LG-5454	54	54	29	4764	4664	5118	218
	xTR1D0LG-6060	60	60	29	5262	5162	5653	242
	*also available w/cabriole base							
Round w/drum base w/sunburst veneer top 	xTR1S0LG-4242	42	42	29	3949*	3876	4052	149
	xTR1S0LG-4848	48	48	29	4949*	4876	5264	176
	xTR1S0LG-5454	54	54	29	6021	5920	6372	218
	xTR1S0LG-6060	60	60	29	6812	6711	7204	242
	*also available w/cabriole bases							
Rectangular w/2 cube bases w/straight grain top 	xTS2C0LG-4284	42	84	29	5405*	4793	5710	372
	xTS2C0LG-4296	42	96	29	5739*	5128	6078	389
	xTS2C0LG-4896	48	96	29	6046*	5438	6407	426
	xTS2C0LG-48120	48	120	29	6790*	6186	7229	466
	*also available w/cabriole bases							
Rectangular w/2 cube bases w/reverse box wedge top 	xTS2C0RW-4284	42	84	29	6301*	5691	6604	372
	xTS2C0RW-4296	42	96	29	6761*	6153	7104	389
	xTS2C0RW-4896	48	96	29	7214*	6606	7576	426
	xTS2C0RW-48120	48	120	29	8251*	7647	8691	466
	*also available w/cabriole base							
Rectangular w/3 cube bases w/straight grain top 	xTS3C0LG-54144	54	144	29	9704	8776	10179	785
	xTS3C0LG-60168	60	168	29	11028	10137	11601	865
	xTS3C0LG-60192	60	192	29	12023	11101	12673	915
	xTS3C0LG-60216	60	216	29	13057	12142	13787	965
	*also available w/cabriole base							

Prices reflect standard CCN cherry or maple finishes

T A B L E S

Description	Model Number(s)	W	D	H	Barrington	Charisma	Tocotta	Weight
-------------	-----------------	---	---	---	------------	----------	---------	--------

**Racetrack w/2 drum bases
w/straight grain top**

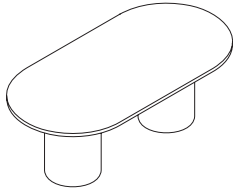

xTR2D0LG-4282	42	84	29	5945*	5787	6355	299
xTR2D0LG-4296	42	96	29	6259*	6103	6709	316
xTR2D0LG-4896	48	96	29	6713*	6599	7186	353
xTR2D0LG-48120	48	120	29	7422*	7275	7969	393

*also available w/cabriole bases

**Racetrack w/3 drum bases
w/straight grain top**

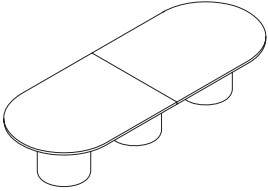

xTR3D0LG-54144	54	144	29	10259	9936	10905	620
xTR3D0LG-60168	60	168	29	11696	11375	12437	700
xTR3D0LG-60192	60	192	29	12653	12336	13473	750
xTR3D0LG-60216	60	216	29	18273	13342	14553	800

**Boat w/2 panel bases
w/straight grain top**

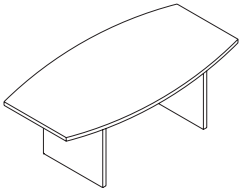

xTB2P0LG-4284	42	84	29	6195	5662	6273	194
xTB2P0LG-4296	42	96	29	6696	6163	6811	211
xTB2P0LG-4896	48	96	29	6946	6416	7078	231
xTB2P0SG-48120	48	120	29	8024	7498	8239	271

**Boat w/3 panel bases
w/straight grain top**

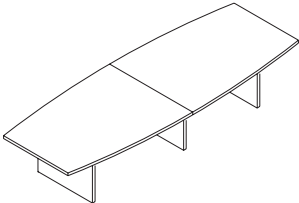

xTB3P0SG-54144	54	144	29	10975	10178	10955	401
xTB3P0SG-60168	60	168	29	12654	11863	12713	482
xTB3P0SG-60192	60	192	29	13983	13194	14119	532

See pages 37-38 for additional table ordering information and for options/accessories

T A B L E S

For more extensive product offering consult the complete Conference Table price list

Description	Model Number(s)	D	W	H	Price (US\$)
Center Drawer/ Personal Drawer	ACD-21	23	21	2	254
	APD-28	23	28	2	311

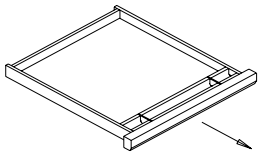

Front pen and clip tray
Species and finish to match unit (drawer head only)

Dictation Tray

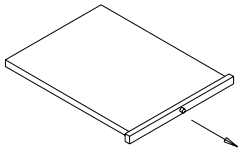

ADTS seated side over box drawer
not for use over file/file 367

ADTA approach side 524

Used in executive desk over b/b/f pedestals only
Species and finish to match unit

**Articulating Keyboard Tray
with Swivel Mouse Tray**

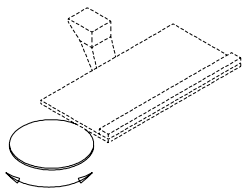

AKTP- 20-SMT 10⁵/₈"D 20³/₁₆"W 407
8¹/₈" dia. mouse tray
graphite color

Ultrasuede wrist pad
Attach to underside of phenolic keyboard tray.

Specify Left or Right

2 1/4" Metal Grommet

AG 225M



- matte black 90
- polished chrome 90
- satin chrome 90
- black chrome 90
- antique brass 90
- polished brass 90

ACCESSORIES

Prices reflect standard CCN cherry or maple finishes

Description	Model Number(s)	Price (US\$)
-------------	-----------------	--------------

Service Opening	ASO-size	170
------------------------	----------	-----

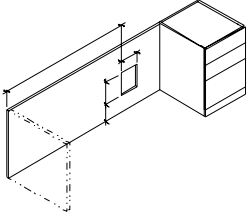

Specify cut out in modesty for access to existing wall outlet
Field dimensions to correspond with building required

Hinged Modesty Panel	AHMPU	362
-----------------------------	-------	-----

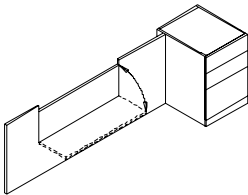

2" opening at top accommodates wire passageway
36" W (maximum) hinged modesty panel
Used in executive bridges and credenzas where access
to wall mounted power/data is needed
Stepped forward to create cavity for wires and plugs

Reception Desk Message Ctr.	AMC-30	30" W with 15 openings	989
	AMC-41	40½" W with 24 openings	1045

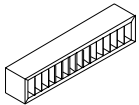

Installs into Gallery Desk sidewall
Wood with clear plexiglass dividers
Open both sides - message pass thru

Reception Desk Organizer	ARDO	509
---------------------------------	------	-----

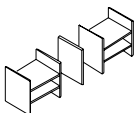

Attaches to worksurface and underside of transaction top
Cannot be used in conjunction with a tasklight

For more extensive product offering
consult the complete Accessories price list.

ACCESSORIES

Description	Model Number(s)	Dimensions	Price (US\$)
-------------	-----------------	------------	--------------

Flip-up Power/Data Module

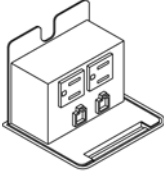

ATA-BB	4 "W 4 "D	brushed brass	379
ATA-SS	4"W 4 "D	brushed stainless steel	379
ATA-CH	4"W 4 "D	polished chrome	548

Unit complete with: (2) 15 amp power receptacles, (1) RJ-11 and (1) RJ-45 comm/data recept. Power Cord Length - 6' (hardwire option not available) for flush mounting into worksurfaces. Unit can be installed in conference tables, credenzas, desks and computer tables. Unit flips open and is held by magnets. Mouse hole in top will allow cords to stay connected when unit is closed.

Inset Power/Data Box w\Flip-up Lid

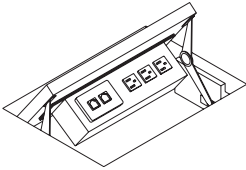

AMUPD-WT	w/black wood accent top	977
	w/non-matching veneer top	977
	w/wood veneer grain to match table to	121

Unit complete with: (3) 15 amp power receptacles, (1) RJ-11, and (1) RJ-45 comm./data receptacles. Power and length - 8' (hardware option not available). Accessed by opening a lid that covers the submerged plug-ins. *Can be used in either the open or closed position.* Cords are positioned in a slot between the lid and work surface.

5-1/2"W x 12 1/2"L

Spring Loaded Power/Data Riser

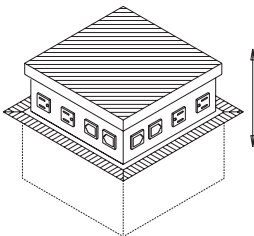

APR	w/black wood accent top	1639
	w/non-matching veneer top	1639
	w/wood veneer grain to match table top	1865

Unit complete with: (8) 15 amp power receptacles, (4) RJ-11, and (4) RJ-45 comm/data receptacles. Power cord length - 6' (hardwire option not available). Provides access to power and comm/data on all four sides. Flush mounts into table top. Black fiber "brushes" rim perimeter of opening to create a clean fit and permit wires to pass through when in a lowered position. Unit is spring loaded - when pressure is applied to the top surface the entire unit "pops-up". Applying pressure to the top again returns the unit to the down position which is then held in place by a detente.

13" x 13" (includes 3/4" brush manager on 4 sides)
Extended Height: 3"

Description	Model Number(s)	Dimensions	Top options	Price (US\$)
-------------	-----------------	------------	-------------	--------------

Wire Trough

AWT-(size)

36 per ft.

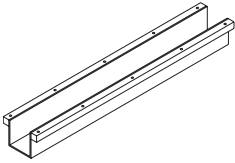

Wire Pass Through Base

SWPT

128

Provides a wire passageway when required. Use with wire trough (see below)

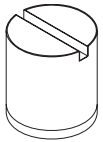

(in drum base)

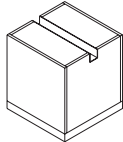

(in cube base)

Base Access Panel

APAD

436

AHAC

436

Permits access to power/data located in the floor and enables power/data routing to the table top

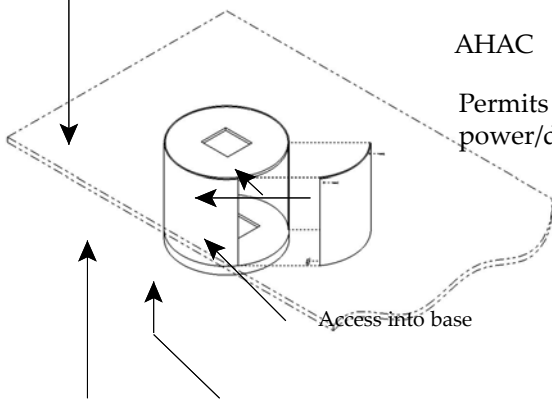

APAD

Access out bottom to floor

Connector bolts

Access panel

"Z" clip

Access into base

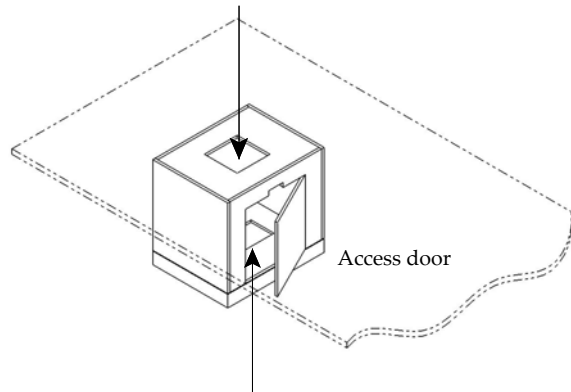

Access door

Access out bottom to floor

APAC

ACCESSORIES