

CONFIGURATION EXAMPLES

Description

Model Number

Price (US\$)
Standard *LE*

Weight
(lbs.)

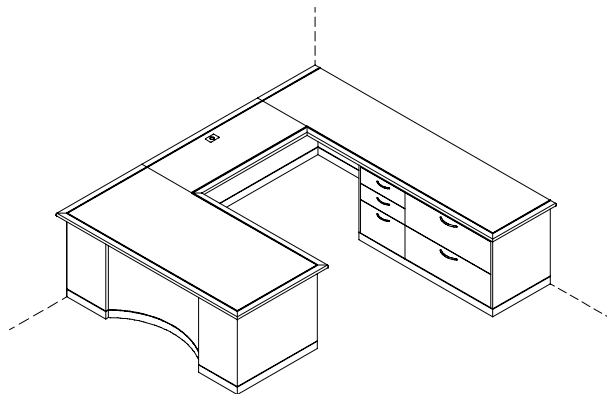

Configuration C/A
overall dimension 104"D x 96"W x 29"H

Components:

Single Pedestal Desk	CDD-3678-CL	6135	7153	278
Center Drawer	ACD-21	262	262	
Executive Height Bridge	CB0-2442	1599	1817	69
Articulating Keyboard Tray	AKTW-22	407	407	
Large Black Grommet	AGR-BL	70	70	
Kneespace Credenza with combination storage	CC0-2696-CFR	<u>6560</u>	<u>7221</u>	<u>325</u>
Totals:		15033	16930	672

LE shown

Configuration C/B
overall dimension 104"D x 84"W x 76"H

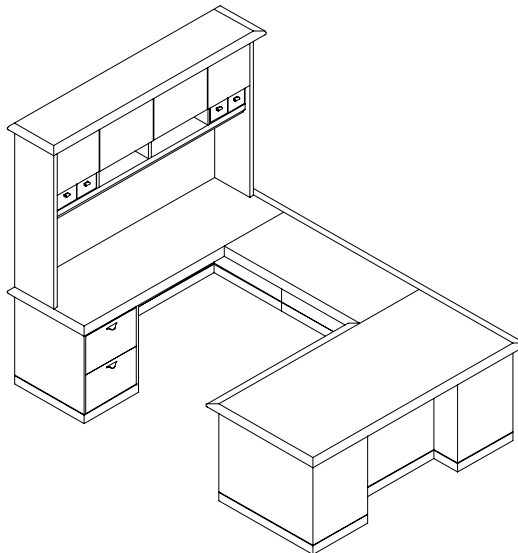

Components:

Single Pedestal Desk	CD0-3672-AR	5284	6082	266
Center Drawer	ACD-21	262	262	
Executive Height Bridge	CB0-2442	1599	1817	69
Single Pedestal Kneespace Credenza	CC0-2684-CL	4774	5379	229
Combination Hi-Rise Storage Organizer Drawers (x2)	CSUD20-1684 AUD	4676 <u>445</u>	5351 <u>445</u>	275 —
Totals:		17040	19336	839

CONFIGURATION EXAMPLES

Description

Model Number

Price (US\$)
Standard *LE*

Weight
(lbs.)

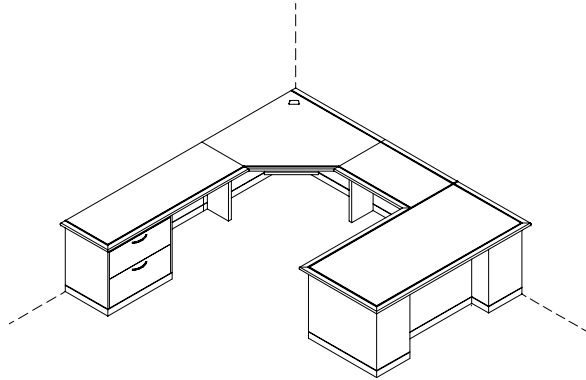

Configuration **C/M**
overall dimension 102"D x 108"W x 29"H

Components:

Single Pedestal Desk	CDD-3672-AR	5984	6966	266
Center Drawer	ACD-21	262	262	
Executive Height Bridge	CB0-2442	1599	1817	69
Executive Height Corner Bridge	CBC-4242	3039	3315	129
Articulating Keyboard Tray	AKTW-22	407	407	
Large Black Grommet	AGR-BL	70	70	
Kneespace Credenza with lateral file	CC0-2166-FL	4589	5077	206
Totals		15950	17914	670

LE shown

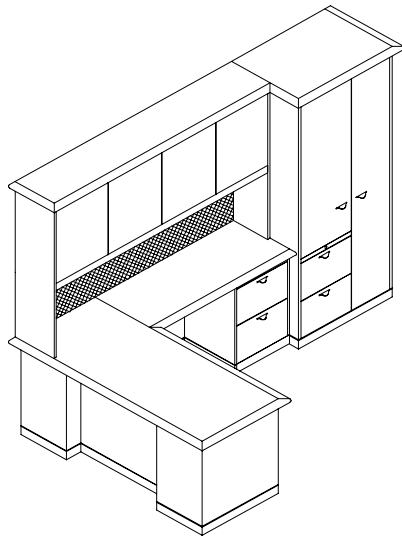

Configuration **C/L**
overall dimension 66"D x 110"W x 76"H

Components:

Single Pedestal Desk	CD0-3066-AL	4943	5659	233
Executive Height Return	CR0-2442-BR	3477	3844	149
Medium Profile Hi-Rise Tackboard	CSUH21-1678 ATBF-78	4362 455	5004 455	259
File Storage Anchor	CSSD132-283476	6336	6458	417
Totals		19573	21420	1058

CONFIGURATION EXAMPLES

Description

Model Number

Price (US\$)
Standard *££*

Weight
(lbs.)

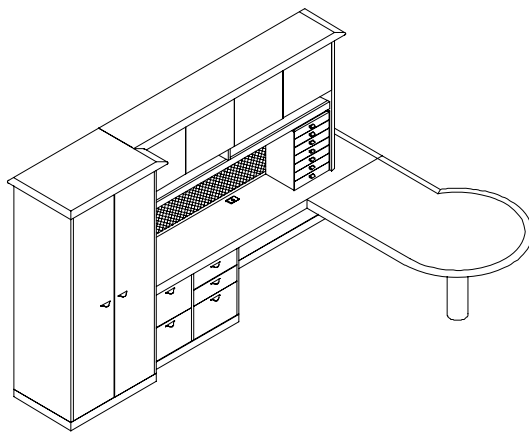

Configuration **C/O**
overall dimension 85"D x 116"W x 76"H

Components:

Run-off P-Top Desk with 6" chrome leg	CDPUH-4266	2503	3180	111
Double Pedestal Credenza Large Black Grommet	CC0-2172-BAL AGR-BL	5740 70	6256 70	256
Combination Hi-Rise Storage Tackboard	CSUD20-1672 ATBF-72	4450 420	5054 420	243
Tasklight (48")	ATL48	232	232	
Upper Storage Flat Drawer Organizer	CSPK-1214	1181	1233	37
Full Shelving Anchor Storage	CSH015-233476	5292	5400	326
Totals		19888	21845	936

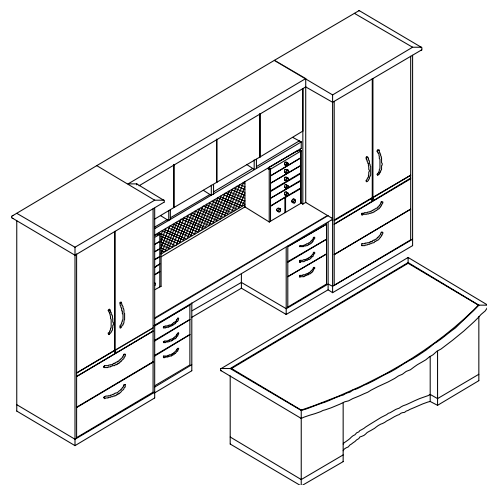

Configuration **C/G**
overall dimension 28"D x 144"W x 76"H

Components:

Double Pedestal Desk	CDD-3672-AB	7087	8069	294
File Storage Anchor	CSS0132L-284076	6681	6811	464
Double Pedestal Kneespace Credenza	CC0-2672-AA	5865	6413	269
Combination Hi-Rise Storage Tackboard	CSUD20-1672 ATBF-44	4450 257	5054 257	243
Tasklight (36")	ATL36	203	203	
Upper Storage Combination Drawer Organizer	CSPJ-1214	1233	1285	37
Upper Storage Combination Drawer Organizer	CSPJ-1214	1233	1285	37
File Storage Anchor	CSS0132R-284076	6681	6811	464
Totals		33690	36188	1808

££ shown

CHARISMA

Above pricing reflects standard cherry and maple finishes. Consult sales representative for any variation of size, configuration, finish or wood species.

CONFIGURATION EXAMPLES

Description

Model Number

Price (US\$)
Standard *LE*

Weight
(lbs.)

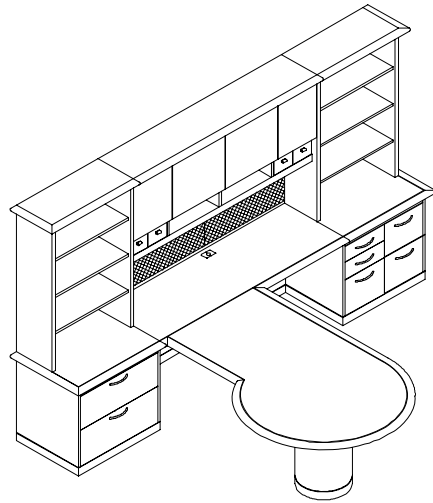

Configuration **C/Q**
overall dimension 90"D x 132"W x 76"H

Components:

Open Shelving over Lateral Files	23	CSFB132L-263476	5056	5172	389
Open Kneespace Credenza Large Black Grommet	14	CC0-2672 AGR-BL	3271 70	3819 70	154
Run-off P-Top Desk	7	CDPU-4266-L	2764	3441	196
Hi-Rise with Linear Organizer Organizer Drawers (x2)	15 20	CSUD20-1672 AUD	4450 445	5054 445	243
Tackboard		ATBF-72	420	420	
Tasklight (48")		ATL48	232	232	
Open Shelving over Double Pedestal		CS2B131R-263476	<u>5564</u>	<u>5681</u>	<u>416</u>

LE shown

Totals 20700 22613 1398

Configuration **C/S**
overall dimension 97½"D x 84"W x 42½"H

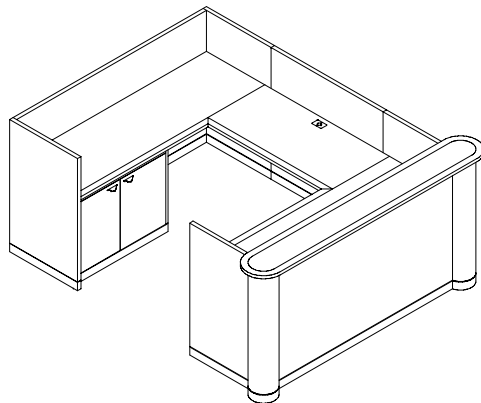

Components:

Reception Desk wth Single Pedestal Center Drawer Large Black Grommet	27	CDCRTR-3484-AR ACD-21 AGR-BL	7986 262 70	9190 262 70	429
Reception Desk Bridge Large Black Grommet	30	CB0R-2442 AGR-BL	2105 70	2162 70	86
Reception Desk Credenza	31	CC0R-2272-HHL	<u>5963</u>	<u>6217</u>	<u>257</u>
Totals			16456	17971	772

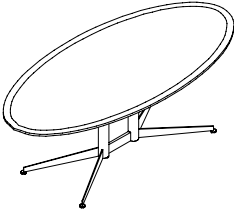
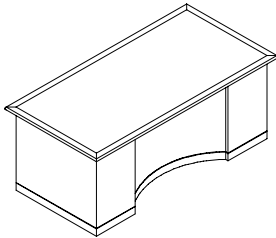
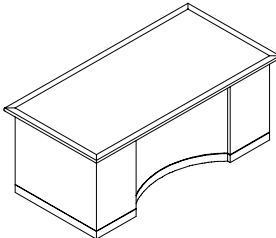
Description	Model Number	Overall Dimensions (in.)			Notes	Price (US\$)		Weight (lbs.)
		Depth	Width	Height		Standard	LE	
	CT016-3472	33½	72	29		7815	8489	150
	CT016-3678	36¼	78	29		8198	8924	163
	CT016-3984	39	84	29		8650	9433	179
	CT016-4290	41¾	90	29		9118	9956	196
Elongated "X" base					Available with Sunburst Pattern Top, contact factory for pricing. LE includes double column metal base & 3/16" metal top inlay			
	CDD-3066-AR	30	66	29	letter width b/b/f pedestal right	5589	6488	233
	CDD-3072-AR	30	72	29	letter width b/b/f pedestal right	5744	6686	243
	CDD-3672-AR	36	72	29	letter width b/b/f pedestal right	5984	6966	266
	CDD-3678-CR	36	78	29	legal width b/b/f pedestal right	6135	7153	278
	CDD-3684-CR	36	84	29	legal width b/b/f pedestal right	6284	7344	289
Concave recessed modesty Specify Left or Right (seated)	(Right indicated)				LE includes 2½" h metal base & 3/16" metal top inlay			
	CDD-3066-AB	30	66	29	letter width b/b/f & f/f pedestals*	6746	7647	269
	CDD-3072-AB	30	72	29	letter width b/b/f & f/f pedestals	6904	7846	279
	CDD-3672-AB	36	72	29	letter width b/b/f & f/f pedestals	7087	8069	294
	CDD-3678-CD	36	78	29	legal width b/b/f & f/f pedestals	7238	8256	305
	CDD-3684-CD	36	84	29	legal width b/b/f & f/f pedestals	7387	8447	316
Concave recessed modesty					*note: narrow kneespace LE includes 2½" h metal base & 3/16" metal top inlay			

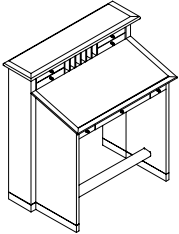
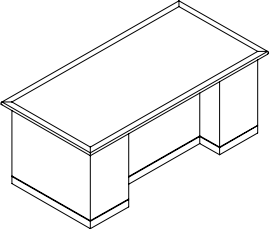
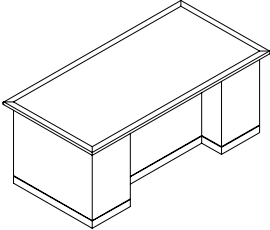
Description	Model Number	Overall Dimensions (in.)			Notes	Price (US\$)		Weight (lbs.)
		Depth	Width	Height		Standard	LE	
	CDI-3348	33	48	52	37½" w kneespace	5382	6192	191
	CDI-3354	33	54	52	43½" w kneespace	5647	6468	214
	CDI-3366	33	66	52	55½" w kneespace	6177	7021	260
					Front edge is 41" h			
Raised organizer components					LE includes 2½" h metal base & 3/16" metal top inlay			
	CD0-3066-AR	30	66	29	letter width b/b/f pedestal right	4943	5659	233
	CD0-3072-AR	30	72	29	letter width b/b/f pedestal right	5070	5829	243
	CD0-3672-AR	36	72	29	letter width b/b/f pedestal right	5284	6082	266
	CD0-3678-CR	36	78	29	legal width b/b/f pedestal right	5408	6244	278
	CD0-3684-CR	36	84	29	legal width b/b/f pedestal right	5530	6407	289
Straight recessed modesty Specify Left or Right (seated)		(Right indicated)			LE includes 2½" h metal base & 3/16" metal top inlay			
	CD0-3066-AB	30	66	29	letter width b/b/f & f/f pedestals*	6100	6817	269
	CD0-3072-AB	30	72	29	letter width b/b/f & f/f pedestals	6232	6988	279
	CD0-3672-AB	36	72	29	letter width b/b/f & f/f pedestals	6388	7185	294
	CD0-3678-CD	36	78	29	legal width b/b/f & f/f pedestals	6511	7347	305
	CD0-3684-CD	36	84	29	legal width b/b/f & f/f pedestals	6634	7510	316
Straight recessed modesty					*note: narrow kneespace LE includes 2½" h metal base & 3/16" metal top inlay			

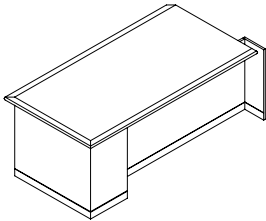
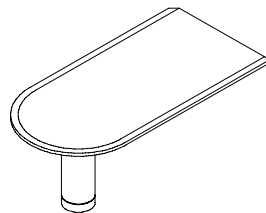
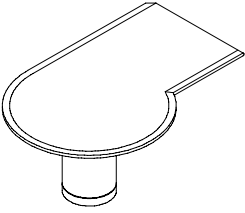
Description	Model Number	Overall Dimensions (in.)			Notes	Price (US\$)		Weight (lbs.)	
		Depth	Width	Height		Standard	LE		
	Run-off Desk w/ Single Pedestal	CDU-3048-AR	30	48	29	letter width b/b/f pedestal right*	4192	4617	159
		CDU-3054-AR	30	54	29	letter width b/b/f pedestal right	4310	4770	169
		CDU-3060-AR	30	60	29	legal width b/b/f pedestal right	4426	4925	179
		CDU-3666-CR	36	66	29	legal width b/b/f pedestal right	4679	5233	202
		CDU-3672-CR	36	72	29	legal width b/b/f pedestal right	4817	5404	214
Extension panel in front of modesty Specify Left or Right (seated)	(Right indicated)					*note: narrow kneespace LE includes 2½" h metal base & 3/16" metal top inlay			
	Run-off Racetrack Desk	CDRU-3048	30	48	29		1878	2402	60
		CDRU-3054	30	54	29		1955	2517	66
		CDRU-3060	30	60	29		2026	2628	73
		CDRU-3666	36	66	29		2204	2861	93
		CDRU-3672	36	72	29		2296	2991	100
8" diameter cylinder leg						LE includes 2½" h metal base & 3/16" metal top inlay			
	Run-off P-Top Desk	CDPU-4266-R	42	66	29	30" square left end, 42" diameter right	2764	3441	196
		CDPU-4272-R	42	72	29	30" square left end, 42" diameter right	2865	3580	205
		CDPU-4872-R	48	72	29	36" square left end, 48" diameter right	2971	3704	220
		CDPU-4878-R	48	78	29	36" square left end, 48" diameter right	3061	3832	230
		CDPU-4884-R	48	84	29	36" square left end, 48" diameter right	3147	3958	240
16" diameter cylinder leg Conferencing on approach side Specify Left or Right (seated)	(Right indicated)					LE includes 2½" h metal base & 3/16" metal top inlay			

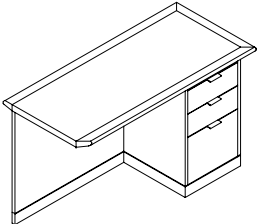
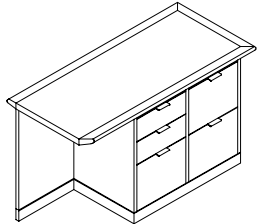
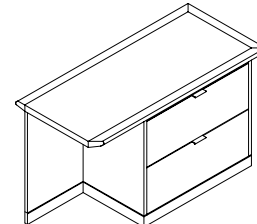
Description	Model Number	Overall Dimensions (in.)			Notes	Price (US\$)		Weight (lbs.)
		Depth	Width	Height		Standard	LE	
	CR0-2442-AR	24	44	29	letter width b/b/f pedestal right*	3477	3844	149
	CR0-2448-AR	24	50	29	letter width b/b/f pedestal right	3585	3992	159
	CR0-2454-CR	24	56	29	legal width b/b/f pedestal right	3696	4137	169
Specify Left or Right (seated)	(Right indicated)	*note: narrow kneespace LE includes 2½" h metal base & 3/16" metal top inlay						
	CR0-2442-ABR	24	44	29	letter width b/b/f & f/f pedestals right*	4946	5316	229
	CR0-2448-ABR	24	50	29	letter width b/b/f & f/f pedestals right*	5058	5461	239
	CR0-2454-CDR	24	56	29	legal width b/b/f & f/f pedestals right*	5166	5609	249
Specify Left or Right (seated)	(Right indicated)	*note: narrow kneespace LE includes 2½" h metal base & 3/16" metal top inlay						
	CR0-2442-FR	24	44	29	34½"w lateral file right*	3760	4130	169
	CR0-2448-FR	24	50	29	34½"w lateral file right*	3873	4275	179
	CR0-2454-FR	24	56	29	34½"w lateral file right*	3980	4423	189
Specify Left or Right (seated)	(Right indicated)	*note: narrow kneespace LE includes 2½" h metal base & 3/16" metal top inlay						

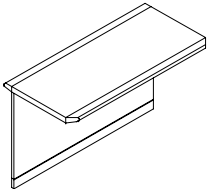
Description	Model Number	Overall Dimensions (in.)			Notes	Price (US\$)		Weight (lbs.)
		Depth	Width	Height		Standard	LE	
	CB0-2124	21	28	29		1227	1354	37
	CB0-2130	21	34	29		1337	1494	46
	CB0-2136	21	40	29		1445	1635	55
	CB0-2142	21	46	29		1556	1775	64
	CB0-2148	21	52	29		1666	1916	74
	CB0-2154	21	60	29		1773	2058	83
	CB0-2424	24	28	29		1267	1393	39
	CB0-2430	24	34	29		1379	1533	49
	CB0-2436	24	40	29		1486	1677	59
	CB0-2442	24	46	29		1599	1817	69
	CB0-2448	24	52	29		1711	1962	79
	CB0-2454	24	60	29		1822	2103	89

Full back panel

LE includes 2½" h metal base & 3/16" metal top inlay

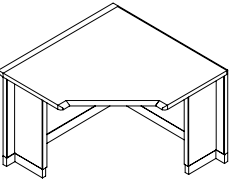
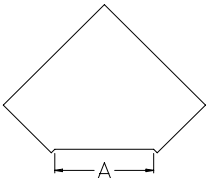
Executive Height Corner Bridge	CBC-3636	36	36	29	Connects to 21" units each side* "A" = 22 ⁵ / ₈ "	2691	2929	103
	CBC-4242	42	42	29	Connects to 21" or 24" units each side* 21" units each side "A" = 31 ¹ / ₈ " 24" unit on one side and 21" or 24" unit on other side "A" = 25 ¹ / ₂ "	3039	3315	129
					*Depth of connecting units will determine actual top size. Corner bridge may be longer and adjacent unit shorter to maintain a 45° front edge. The adjustment will be made at the factory and will not affect the overall configured size.			
								

Full back panels with 10" deep perpendicular support legs
Please provide drawing to show connecting units

LE includes 2½" h metal base & 3/16" metal top inlay

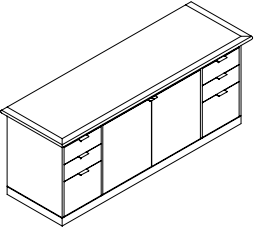
Description	Model Number	Overall Dimensions (in.)			Notes	Price (US\$)		Weight (lbs.)
		Depth	Width	Height		Standard	LE	
	CC0-2166-AHHA	21	66	29	letter width b/b/f pedestals, 2 hinged doors center	7101	7589	308
	CC0-2172-AHHA	21	72	29	letter width b/b/f pedestals, 2 hinged doors center	7205	7722	316
	CC0-2178-CHHC	21	78	29	legal width b/b/f pedestals, 2 hinged doors center	7305	7851	324
	CC0-2184-CHHC	21	84	29	legal width b/b/f pedestals, 2 hinged doors center	7404	7976	332
	CC0-2666-AHHA	26	66	29	letter width b/b/f pedestals, 2 hinged doors center	7222	7744	319
	CC0-2672-AHHA	26	72	29	letter width b/b/f pedestals, 2 hinged doors center	7334	7884	329
	CC0-2678-CHHC	26	78	29	legal width b/b/f pedestals, 2 hinged doors center	7437	8014	338
	CC0-2684-CHHC	26	84	29	legal width b/b/f pedestals, 2 hinged doors center	7538	8145	347

1 adjustable shelf behind pair of center hinged doors

LE includes 2½" h metal base & 3/16" metal top inlay

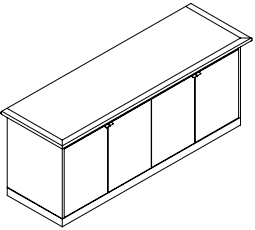
	CC0-2166-HHHH	21	66	29	2 bay, 4 hinged doors	5296	5781	208
	CC0-2172-HHHH	21	72	29	2 bay, 4 hinged doors	5400	5917	216
	CC0-2178-HHHH	21	78	29	2 bay, 4 hinged doors	5501	6047	224
	CC0-2184-HHHH	21	84	29	2 bay, 4 hinged doors	5599	6171	232
	CC0-2666-HHHH	26	66	29	2 bay, 4 hinged doors	5412	5931	219
	CC0-2672-HHHH	26	72	29	2 bay, 4 hinged doors	5523	6074	229
	CC0-2678-HHHH	26	78	29	2 bay, 4 hinged doors	5626	6201	238
	CC0-2684-HHHH	26	84	29	2 bay, 4 hinged doors	5730	6335	247

1 adjustable shelf behind each pair hinged doors
2 pair of equal size hinged doors

LE includes 2½" h metal base & 3/16" metal top inlay

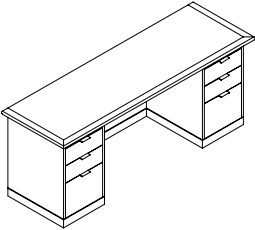
Description	Model Number	Overall Dimensions (in.)			Notes	Price (US\$)		Weight (lbs.)
		Depth	Width	Height		Standard	LE	
Double Pedestal Kneespace Credenza 	CC0-2166-AA	21	66	29	2 letter width b/b/f pedestals*	5632	6120	248
	CC0-2172-AA	21	72	29	2 letter width b/b/f pedestals	5740	6256	256
	CC0-2178-CC	21	78	29	2 legal width b/b/f pedestals	5840	6382	264
	CC0-2184-CC	21	84	29	2 legal width b/b/f pedestals	5938	6508	272
	CC0-2666-AA	26	66	29	2 letter width b/b/f pedestals*	5753	6275	259
	CC0-2672-AA	26	72	29	2 letter width b/b/f pedestals	5865	6413	269
	CC0-2678-CC	26	78	29	2 legal width b/b/f pedestals	5968	6545	278
	CC0-2684-CC	26	84	29	2 legal width b/b/f pedestals	6069	6674	287

*note: narrow kneespace
 LE includes 2½" h metal base & 3/16" metal top inlay

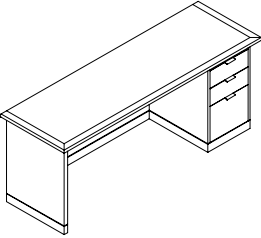
Single Pedestal Kneespace Credenza 	CC0-2166-AR	21	66	29	letter width b/b/f pedestal	4306	4795	186
	CC0-2172-AR	21	72	29	letter width b/b/f pedestal	4415	4930	194
	CC0-2178-CR	21	78	29	legal width b/b/f pedestal	4514	5056	202
	CC0-2184-CR	21	84	29	legal width b/b/f pedestal	4613	5184	210
	CC0-2666-AR	26	66	29	letter width b/b/f pedestal	4454	4977	202
	CC0-2672-AR	26	72	29	letter width b/b/f pedestal	4566	5118	211
	CC0-2678-CR	26	78	29	legal width b/b/f pedestal	4673	5427	220
	CC0-2684-CR	26	84	29	legal width b/b/f pedestal	4774	5379	229

Specify Left or Right (right shown)

LE includes 2½" h metal base & 3/16" metal top inlay

CHARISMA

Above pricing reflects standard cherry and maple finishes. Consult sales representative for any variation of size, configuration, finish or wood species.

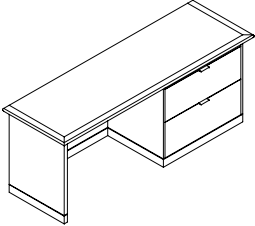
Description	Model Number	Overall Dimensions (in.)			Notes	Price (US\$)		Weight (lbs.)
		Depth	Width	Height		Standard	££	
	CC0-2166-FR	21	66	29	1- 34½"w lateral file*	4589	5077	206
	CC0-2172-FR	21	72	29	1- 34½"w lateral file	4696	5213	214
	CC0-2178-FR	21	78	29	1- 34½"w lateral file	4796	5339	222
	CC0-2184-FR	21	84	29	1- 34½"w lateral file	4895	5467	230
	CC0-2666-FR	26	66	29	1- 34½"w lateral file*	4738	5258	222
	CC0-2672-FR	26	72	29	1- 34½"w lateral file	4852	5400	231
	CC0-2678-FR	26	78	29	1- 34½"w lateral file	4955	5531	240
	CC0-2684-FR	26	84	29	1- 34½"w lateral file	5057	5661	249

*note: narrow kneespace

££ includes 2½" h metal base & 3/16" metal top inlay

Specify Left or Right (right shown)

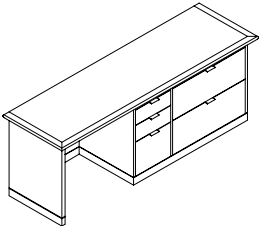
	CC0-2178-AFR	21	78	29	letter width b/b/f pedestal 1- 34½"w lateral file*	6122	6665	284
	CC0-2184-CFR	21	84	29	legal width b/b/f pedestal 1- 34½"w lateral file*	6222	6790	292
	CC0-2196-CFR	21	96	29	legal width b/b/f pedestal 1- 34½"w lateral file	6421	7046	308
	CC0-2678-AFR	26	78	29	letter width b/b/f pedestal 1- 34½"w lateral file*	6250	6827	298
	CC0-2684-CFR	26	84	29	legal width b/b/f pedestal 1- 34½"w lateral file*	6352	6956	307
	CC0-2696-CFR	26	96	29	legal width b/b/f pedestal 1- 34½"w lateral file	6560	7221	325

*note: narrow kneespace

££ includes 2½" h metal base & 3/16" metal top inlay

Specify Left or Right (right shown)

CHARISMA

Above pricing reflects standard cherry and maple finishes. Consult sales representative for any variation of size, configuration, finish or wood species.

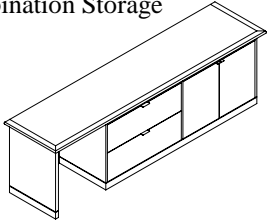
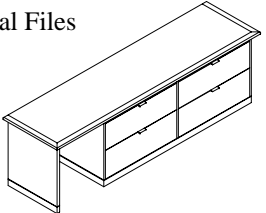
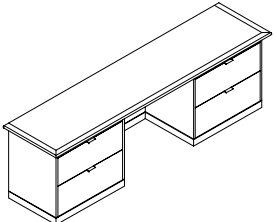
Description	Model Number	Overall Dimensions (in.)			Notes	Price (US\$)		Weight (lbs.)
		Depth	Width	Height		Standard	LE	
Extended Credenza with Combination Storage 	CC0-2196-EHHR	21	96	29	28½" w lateral file, 28½" w hinged door	6421	7046	288
	CC0-21108-FHHR	21	108	29	34½" w lateral file, 34½" w hinged door	6618	7302	304
	CC0-2696-EHHR	26	96	29	28½" w lateral file, 28½" w hinged door	6560	7221	305
	CC0-26108-FHHR	26	108	29	34½" w lateral file, 34½" w hinged door	6769	7485	323
Specify Left or Right (seated) Unit will ship as 1 piece unless specified otherwise					<i>LE includes 2½" h metal base & 3/16" metal top inlay</i>			
Extended Credenza with Double Lateral Files 	CC0-2196-EER	21	96	29	2- 28½" w lateral files	6702	7328	328
	CC0-21108-FFR	21	108	29	2- 34½" w lateral files	6901	7583	344
	CC0-2696-EER	26	96	29	2- 28½" w lateral files	6842	7503	345
	CC0-26108-FFR	26	108	29	2- 34½" w lateral files	7050	7769	363
Specify Left or Right (seated) Unit will ship as 1 piece unless specified otherwise					<i>LE includes 2½" h metal base & 3/16" metal top inlay</i>			
Extended Kneespace Credenza with Double Lateral Files 	CC0-2196-EE	21	96	29	2- 28½" w lateral files	6702	7328	328
	CC0-21108-FF	21	108	29	2- 34½" w lateral files	6901	7583	344
	CC0-21120-FF	21	120	29	2- 34½" w lateral files	7099	7839	360
	CC0-2696-EE	26	96	29	2- 28½" w lateral files	6842	7503	345
	CC0-26108-FF	26	108	29	2- 34½" w lateral files	7050	7769	363
	CC0-26120-FF	26	120	29	2- 34½" w lateral files	7255	8030	381
Unit will ship as 1 piece unless specified otherwise					<i>LE includes 2½" h metal base & 3/16" metal top inlay</i>			

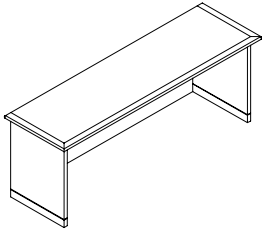
Description	Model Number	Overall Dimensions (in.)			Notes	Price (US\$)		Weight (lbs.)
		Depth	Width	Height		Standard	LE	
	CC0-2166	21	66	29		2981	3469	124
	CC0-2172	21	72	29		3088	3605	132
	CC0-2178	21	78	29		3188	3731	140
	CC0-2184	21	84	29		3287	3859	148
	CC0-2666	26	66	29		3159	3682	144
	CC0-2672	26	72	29		3271	3819	154
	CC0-2678	26	78	29		3374	3952	163
	CC0-2684	26	84	29		3476	4083	172

LE includes 2½" h metal base & 3/16" metal top inlay

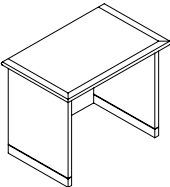
	CC0-2130	21	30	29		2388	2709	76
	CC0-2136	21	36	29		2487	2835	84
	CC0-2142	21	42	29		2585	2962	92
	CC0-2148	21	48	29		2686	3088	100
	CC0-2630	26	30	29		2549	2900	90
	CC0-2636	26	36	29		2648	3032	99
	CC0-2642	26	42	29		2750	3162	108
	CC0-2648	26	48	29		2853	3291	117

LE includes 2½" h metal base & 3/16" metal top inlay

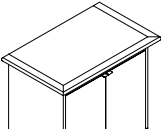
	CSH011-2134	21	34	29		2543	2834	126
	CSH011-2140	21	40	29		2755	3066	142
	CSH011-2634	26	34	29		2755	3082	146
	CSH011-2640	26	40	29		2980	3326	165

1 adjustable shelf behind doors

(note: no lock standard)

LE includes 2½" h metal base & 3/16" metal top inlay

CHARISMA

Above pricing reflects standard cherry and maple finishes. Consult sales representative for any variation of size, configuration, finish or wood species.

Description	Model Number	Overall Dimensions (in.)			Notes	Price (US\$)		Weight (lbs.)
		Depth	Width	Height		Standard	LE	
Combination Hi-Rise Storage with Upper Hinged Doors and Linear Organizer	CSUD20-1666	16	66	47	2 bay, 4 hinged doors	4310	4880	227
	CSUD20-1672	16	72	47	2 bay, 4 hinged doors	4450	5054	243
	CSUD20-1678	16	78	47	2 bay, 4 hinged doors	4563	5204	259
	CSUD20-1684	16	84	47	2 bay, 4 hinged doors	4676	5351	275

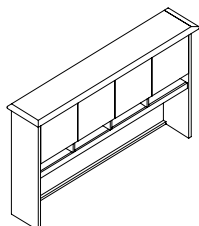

Unit will ship as 1 piece unless specified otherwise

LE includes 4 wood framed patterned glass doors
Optional Organizer Drawers (see page 20 for pricing)

Combination Hi-Rise Storage with Upper Hinged Doors and Linear Organizer	CSUD30-1696	16	96	47	3 bay, 6 hinged doors	5599	6440	314
	CSUD30-16108	16	108	47	3 bay, 6 hinged doors	5825	6733	346
	CSUD30-16120	16	120	47	3 bay, 6 hinged doors	6053	7031	378

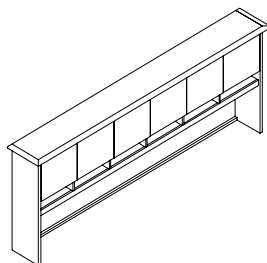

Unit will ship as 1 piece unless specified otherwise

LE includes 6 wood framed patterned glass doors
Optional Organizer Drawers (see page 20 for pricing)

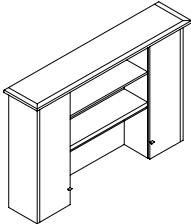
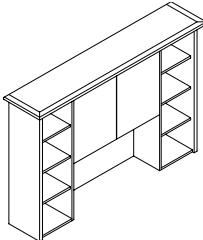
Description	Model Number	Overall Dimensions (in.)			Notes	Price (US\$)		Weight (lbs.)
		Depth	Width	Height		Standard	LE	
 <p>Split Door Hi-Rise Storage</p>	CSUI331-1666	16	66	47	end hinged doors, 30½" w open center shelf	5008	5493	306
	CSUI331-1672	16	72	47	end hinged doors, 36½" w open center shelf	5146	5657	326
	CSUI331-1678	16	78	47	end hinged doors, 36½" w open center shelf	5268	5807	346
	CSUI431-1684	16	84	47	end hinged doors, 2 - 20 ⁷ / ₈ " w double bay center	5526	6092	373
	CSUI331-1696	16	96	47	2 hinged doors each end, 32" w open center shelf	5716	6662	420
	CSUI331-16108	16	108	47	2 hinged doors each end, 32" w open center shelf	5970	6989	462
	CSUI431-16120	16	120	47	2 hinged doors each end, 2 - 21 ⁵ / ₈ " w double bay center	6607	7699	511
3 adjustable shelves behind end doors 1 adjustable center shelf Unit will ship as 1 piece unless specified otherwise					(note: 20" clearance between center fixed bottom shelf and worksurface) LE includes 2 wood framed patterned glass doors			
 <p>Split Shelving Hi-Rise Storage with Center Doors</p>	CSUC331-1666	16	66	47	end open shelves, 2 center hinged doors 30½" w center opening	4810	5094	269
	CSUC331-1672	16	72	47	end open shelves, 2 center hinged doors 36½" w center opening	4929	5231	285
	CSUC331-1678	16	78	47	end open shelves, 2 center hinged doors 36½" w center opening	5030	5351	302
	CSUC431-1684	16	84	47	end open shelves, 2 center hinged doors 2 - 20 ⁷ / ₈ " w double bay center	5561	5900	326
	CSUC331-1696	16	96	47	end open shelves, 2 center hinged doors 32" w center opening	5295	5573	342
	CSUC331-16108	16	108	47	end open shelves, 2 center hinged doors 32" w center opening	5493	5798	374
	CSUC431-16120	16	120	47	end open shelves, 2 center hinged doors 2 - 21 ⁵ / ₈ " w double bay center	6371	6696	413
3 adjustable end shelves 1 adjustable shelf behind doors Unit will ship as 1 piece unless specified otherwise					(note: 20" clearance between center fixed bottom shelf and worksurface) LE includes 2 wood framed patterned glass doors			

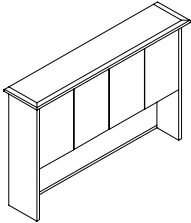
Description	Model Number	Overall Dimensions (in.)			Notes	Price (US\$)		Weight (lbs.)
		Depth	Width	Height		Standard	££	
	CSUH21-1666	16	66	47	2 bay, 4 hinged doors	4121	4692	227
	CSUH21-1672	16	72	47	2 bay, 4 hinged doors	4252	4857	243
	CSUH21-1678	16	78	47	2 bay, 4 hinged doors	4362	5004	259
	CSUH21-1684	16	84	47	2 bay, 4 hinged doors	4471	5147	275
	CSUH31-1696	16	96	47	3 bay, 6 hinged doors	5371	6210	314
	CSUH31-16108	16	108	47	3 bay, 6 hinged doors	5594	6501	346
	CSUH31-16120	16	120	47	3 bay, 6 hinged doors	5816	6792	378

1 adjustable shelf behind each pair of doors
Unit will ship as 1 piece unless specified otherwise

(note: 20" clearance between fixed
bottom shelf and worksurface)
££ includes 4 wood framed patterned glass doors

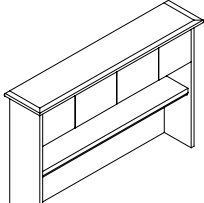
	CSUE20-1666	16	66	47	2 bay, 4 hinged doors	4139	4710	227
	CSUE20-1672	16	72	47	2 bay, 4 hinged doors	4277	4884	243
	CSUE20-1678	16	78	47	2 bay, 4 hinged doors	4390	5031	259
	CSUE20-1684	16	84	47	2 bay, 4 hinged doors	4502	5180	275
	CSUE30-1696	16	96	47	3 bay, 6 hinged doors	5314	6151	314
	CSUE30-16108	16	108	47	3 bay, 6 hinged doors	5539	6448	346
	CSUE30-16120	16	120	47	3 bay, 6 hinged doors	5765	6745	378

Unit will ship as 1 piece unless specified otherwise

££ includes 4 wood framed patterned glass doors

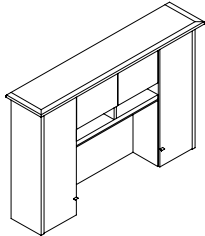
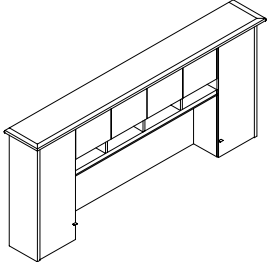
Description	Model Number	Overall Dimensions (in.)			Notes	Price (US\$)		Weight (lbs.)
		Depth	Width	Height		Standard	LE	
Combination Hi-Rise Storage with Upper Hinged Doors and Linear Organizer 	CSUF330-1666	16	66	47	3 bay, 4 hinged doors, 30½" w center opening	5700	6181	312
	CSUF330-1672	16	72	47	3 bay, 4 hinged doors, 36½" w center opening	5836	6345	333
	CSUF330-1678	16	78	47	3 bay, 4 hinged doors, 36½" w center opening	5953	6492	353
	CSUF330-1684	16	84	47	3 bay, 4 hinged doors, 42½" w center opening	6071	6638	373
3 adjustable shelves behind end doors Unit will ship as 1 piece unless specified otherwise					(note: 20" clearence between center fixed bottom shelf and worksurface) LE includes 2 wood framed, patterned glass outside doors, 2 wood panel center doors & enhanced metal access hardware Optional Organizer Drawers (see page 20 for pricing)			
Combination Hi-Rise Storage with Upper Hinged Doors and Linear Organizer 	CSUF430-1696	16	96	47	4 bay, 6 hinged doors, 32" w center opening	6947	7893	429
	CSUF430-16108	16	108	47	4 bay, 6 hinged doors, 32"w center opening	7188	8208	470
	CSUF430-16120	16	120	47	4 bay, 6 hinged doors, 44"w center opening	7432	8525	511
3 adjustable shelves behind end doors Unit will ship as 1 piece unless specified otherwise					(note: 20" clearence between center fixed bottom shelf and worksurface) LE includes 2 wood framed, patterned glass outside doors, 4 wood panel center doors & enhanced metal access hardware Optional Organizer Drawers (see page 20 for pricing)			

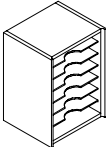
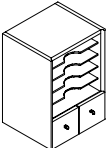
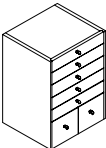
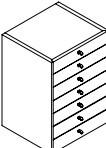
Description	Model Number	Overall Dimensions (in.)			Notes	Price (US\$)		Weight (lbs.)
		Depth	Width	Height		Standard	LE	
Upper Storage Open Organizer	CSPS-1214	12¼	14¼	20	12½"w shelves	885	937	33
	CSPS-1217	12¼	17¼	20	15½"w shelves	999	1054	38
					(note: can only be used in Hi-Rise Storage units with 20" clearance between fixed bottom shelf and worksurface)			
6- ¼" black dividers, 7 openings								
Upper Storage Combination Organizer	CSPI-1214	12¼	14¼	20	12½"w shelves, 5"w drawers	1015	1067	36
	CSPI-1217	12¼	17¼	20	15½"w shelves, 6½"w drawers	1124	1180	42
					(note: can only be used in Hi-Rise Storage units with 20" clearance between fixed bottom shelf and worksurface)			
4- ¼" black dividers, 5 openings 2- 5¼" base box drawers					LE includes enhanced metal hardware			
Upper Storage Combination Organizer	CSPJ-1214	12¼	14¼	20	11½"w upper drawers, 5"w lower drawers	1233	1285	37
	CSPJ-1217	12¼	17¼	20	14½"w upper drawers, 6½"w lower drawers	1349	1405	43
					(note: can only be used in Hi-Rise Storage units with 20" clearance between fixed bottom shelf and worksurface)			
5- 2¾" upper flat drawers 2- 5¼" base box drawers					LE includes enhanced metal hardware			
Upper Storage Flat Drawer Organizer	CSPK-1214	12¼	14¼	20	11½"w drawers	1181	1233	37
	CSPK-1217	12¼	17¼	20	14½"w drawers	1297	1353	43
					(note: can only be used in Hi-Rise Storage units with 20" clearance between fixed bottom shelf and worksurface)			
7- 2¾" flat drawers					LE includes enhanced metal hardware			

Description	Model Number	Overall Dimensions (in.)			Notes	Price (US\$)		Weight (lbs.)
		Depth	Width	Height		Standard	££	
Upper Storage Organizer Drawers	AUD				Set of 2 Drawers		223	

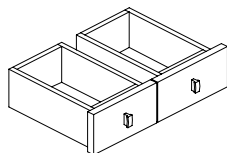

2 drawers per opening

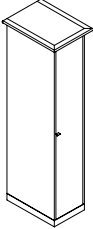
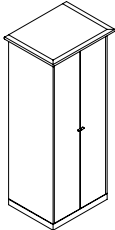
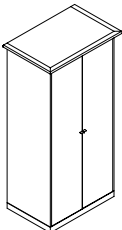
Description	Model Number	Overall Dimensions (in.)			Notes	Price (US\$)		Weight (lbs.)	
		Depth	Width	Height		Standard	LE		
	Full Shelving Anchor Storage	CSH015R-232076	23	19¾	76	full height hinged door with coat hook	4482	4571	232
		CSH015R-232376	23	22¾	76	full height hinged door with coat hook	4656	4749	252
		CSH015R-282076	28	19¾	76	full height hinged door with coat hook	4770	4873	268
		CSH015R-282376	28	22¾	76	full height hinged door with coat hook	4955	5062	291
5 adjustable shelves behind door Specify Left or Right hinged door (right shown)						(note: no lock standard) LE includes 2½" h metal base & enhanced metal access hardware			
	Full Shelving Anchor Storage	CSH015-233476	23	34	76	2 full height hinged doors	5292	5400	326
		CSH015-234076	23	40	76	2 full height hinged doors	5640	5756	366
		CSH015-283476	28	34	76	2 full height hinged doors	5644	5766	373
		CSH015-284076	28	40	76	2 full height hinged doors	6018	6148	418
5 adjustable shelves behind doors						(note: no lock standard) LE includes 2½" h metal base & enhanced metal access hardware			
	Wardrobe-Shelving Anchor Storage	CSD025-283476	28	34	76	2 full height hinged doors 5 adjustable shelves on right half Coat rod on left half	6277	6399	418
	Full Wardrobe Anchor	CSD025-284076	28	40	76	2 full height hinged doors 5 adjustable shelves on right half Coat rod on left half	6649	6779	463
		CSC011-283476	28	34	76	2 full height hinged doors full width coat rod & hat shelf inside	4443	4565	294
		CSC011-284076	28	40	76	2 full height hinged doors full width coat rod & hat shelf inside	4739	4869	325
						(note: no lock standard) LE includes 2½" h metal base & enhanced metal access hardware			

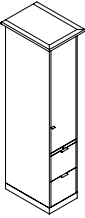
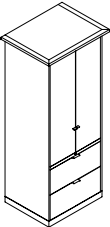
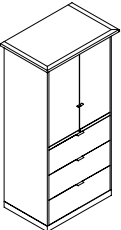
Description	Model Number	Overall Dimensions (in.)			Notes	Price (US\$)		Weight (lbs.)
		Depth	Width	Height		Standard	LE	
	CSS0132R-232076	23	19¾	76	2 letter width file drawers	5266	5355	268
	CSS0132R-232376	23	22¾	76	2 legal width file drawers	5427	5521	289
	CSS0132R-282076	28	19¾	76	2 letter width file drawers	5532	5635	306
	CSS0132R-282376	28	22¾	76	2 legal width file drawers	5705	5813	330
3 adjustable upper shelves behind hinged door Specify Left or Right hinged door (right shown)					(note: lock standard on drawers only) LE includes 2½" h metal base & enhanced metal access hardware			
	CSS0132-233476	23	34	76	2- 28½" w lateral file drawers	6021	6129	367
	CSS0132-234076	23	40	76	2- 34½" w lateral file drawers	6342	6458	409
	CSS0132-283476	28	34	76	2- 28½" w lateral file drawers	6336	6458	417
	CSS0132-284076	28	40	76	2- 34½" w lateral file drawers	6681	6811	464
3 adjustable upper shelves behind pair of hinged doors					(note: lock standard on drawers only) LE includes 2½" h metal base & enhanced metal access hardware			
	CSS0123-233476	23	34	76	3- 28½" w lateral file drawers	6354	6462	365
	CSS0123-234076	23	40	76	3- 34½" w lateral file drawers	6664	6780	405
	CSS0123-283476	28	34	76	3- 28½" w lateral file drawers	6652	6774	412
	CSS0123-284076	28	40	76	3- 34½" w lateral file drawers	6979	7109	456
2 adjustable upper shelves behind pair of hinged doors					(note: lock standard on drawers only) LE includes 2½" h metal base & enhanced metal access hardware			

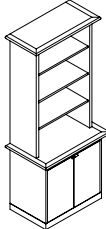
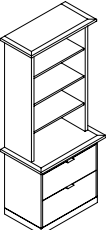
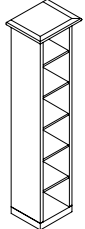
Description	Model Number	Overall Dimensions (in.)			Notes	Price (US\$)		Weight (lbs.)
		Depth	Width	Height		Standard	LE	
	CSHB131-213476	21	34	76	adjustable shelf behind lower hinged doors	4495	4598	291
	CSHB131-214076	21	40	76	adjustable shelf behind lower hinged doors	4830	4940	324
	CSHB131-263476	26	34	76	adjustable shelf behind lower hinged doors	4878	4995	347
	CSHB131-264076	26	40	76	adjustable shelf behind lower hinged doors	5244	5369	386
3 adjustable upper shelves 16" upper unit depth					(note: no lock standard) LE includes 2½" metal base & enhanced metal access hardware			
	CSFB132-213476	21	34	76	2- 28½"w lateral file drawers	4703	4806	330
	CSFB132-214076	21	40	76	2- 34½"w lateral file drawers	5004	5114	366
	CSFB132-263476	26	34	76	2- 28½"w lateral file drawers	5056	5172	389
	CSFB132-264076	26	40	76	2- 34½ lateral file drawers	5382	5506	430
3 adjustable upper shelves 16" upper unit depth					(note: lock standard on drawers only) LE includes 2½" metal base			
	CSB015-162076	16	19¾	76	5 adjustable shelves	2885	2955	149
	CSB015-162376	16	22¾	76	5 adjustable shelves	2961	3035	161
	CSB015-232076	23	19¾	76	5 adjustable shelves	3165	3254	200
	CSB015-232376	23	22¾	76	5 adjustable shelves	3260	3354	215
					LE includes 2½" metal base			

Description	Model Number	Overall Dimensions (in.)			Notes	Price (US\$)		Weight (lbs.)
		Depth	Width	Height		Standard	LE	
2 Drawer Lateral File	CSF0102-2134	21	34	29	2- 28½"w lateral file drawers	2468	2759	190
	CSF0102-2140	21	40	29	2- 34½"w lateral file drawers	2532	2842	208

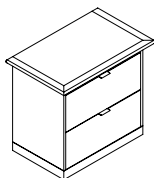

LE includes 2½" metal base & 3/16" metal top inlay

3 Drawer Lateral File	CSF0103-2134	21	34	42½	3- 28½"w lateral file drawers	3269	3561	253
	CSF0103-2140	21	40	42½	3- 34½"w lateral file drawers	3348	3661	274

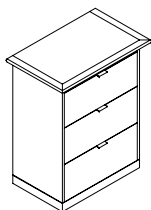

LE includes 2½" metal base & 3/16" metal top inlay

4 Drawer Lateral File	CSF0104-2134	21	34	54¾	4- 28½"w lateral file drawers	4043	4337	310
	CSF0104-2140	21	40	54¾	4- 34½"w lateral file drawers	4137	4450	334

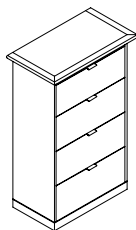

LE includes 2½" metal base & 3/16" metal top inlay

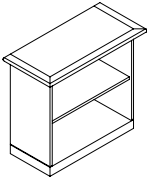
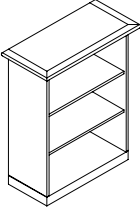
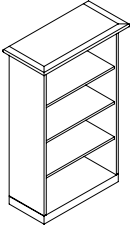
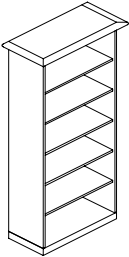
Description	Model Number	Overall Dimensions (in.)			Notes	Price (US\$)		Weight (lbs.)
		Depth	Width	Height		Standard	££	
Single Bay Bookcase 	CSB011-1534	15	34	29	1 adjustable shelf	1709	1961	80
	CSB011-1540	15	40	29	1 adjustable shelf	1770	2043	90
<i>(note: single binder shelf) ££ includes 2½" metal base & 3/16" metal top inlay</i>								
Single Bay Bookcase 	CSB012-1534	15	34	42½	2 adjustable shelves	2072	2327	112
	CSB012-1540	15	40	42½	2 adjustable shelves	2155	2427	126
<i>££ includes 2½" metal base & 3/16" metal top inlay</i>								
Single Bay Bookcase 	CSB013-1534	15	34	54¾	3 adjustable shelves	2491	2746	143
	CSB013-1540	15	40	54¾	3 adjustable shelves	2600	2874	160
<i>££ includes 2½" metal base & 3/16" metal top inlay</i>								
Single Bay Bookcase 	CSB015-1534	15	34	76	5 adjustable shelves	3190	3277	196
	CSB015-1540	15	40	76	5 adjustable shelves	3336	3431	220
<i>££ includes 2½" metal base & 3/16" metal top inlay</i>								

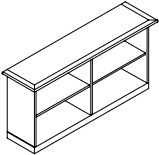
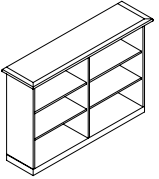
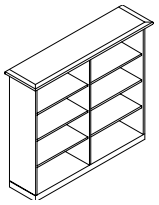
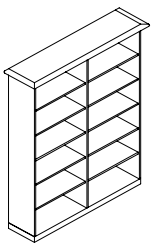
Description	Model Number	Overall Dimensions (in.)			Notes	Price (US\$)		Weight (lbs.)
		Depth	Width	Height		Standard	LE	
Double Bay Bookcase	CSB021-1563	15	63¼	29	1 adjustable shelf each bay	2492	2843	137
	CSB021-1575	15	75¼	29	1 adjustable shelf each bay	2626	3015	157
					(note: single binder shelf) LE includes 2½" h metal base & 3/16" metal top inlay			
Double Bay Bookcase	CSB022-1563	15	63¼	42½	2 adjustable shelves each bay	3164	3512	191
	CSB022-1575	15	75¼	42½	2 adjustable shelves each bay	3337	3726	218
					LE includes 2½" h metal base & 3/16" metal top inlay			
Double Bay Bookcase	CSB023-1563	15	63¼	54¾	3 adjustable shelves each bay	3936	4284	242
	CSB023-1575	15	75¼	54¾	3 adjustable shelves each bay	4178	4565	276
					LE includes 2½" h metal base & 3/16" metal top inlay			
Double Bay Bookcase	CSB025-1563	15	63¼	76	5 adjustable shelves each bay	5231	5357	333
	CSB025-1575	15	75¼	76	5 adjustable shelves each bay	5545	5687	380
					LE includes 2½" h chrome base & 3/16" chrome top inlay			

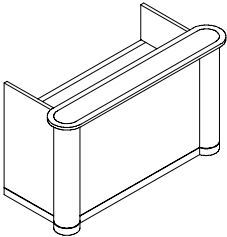
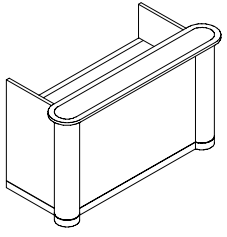
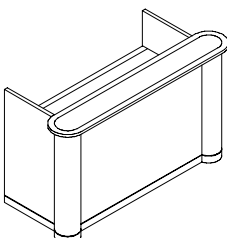
Description	Model Number	Overall Dimensions (in.)			Notes	Price (US\$)		Weight (lbs.)
		Depth	Width	Height		Standard	LE	
Reception Desk Enclosure w/ Column Corners 	CDCRTR-3472	33½	72	42½	57½" w kneespace	6197	7294	315
	CDCRTR-3484	33½	84	42½	69½" w kneespace	6517	7721	349
	CDCRTR-3496	33½	96	42½	81½" w kneespace	6838	8153	384
Racetrack transaction top					LE includes 2½" h metal base & 3/16" metal transaction top inlay			
Single Pedestal Reception Desk w/ Column Corners 	CDCRTR-3472-AR	33½	72	42½	letter width b/b/f pedestal*	7667	8763	395
	CDCRTR-3484-AR	33½	84	42½	letter width b/b/f pedestal	7986	9190	429
	CDCRTR-3496-CR	33½	96	42½	legal width b/b/f pedestal	8307	9622	464
Racetrack transaction top	Specify Left or Right (seated)				*note: kneespace too narrow for return LE includes 2½" h metal base & 3/16" metal transaction top inlay			
Double Pedestal Reception Desk w/ Column Corners 	CDCRTR-3472-AB	33½	72	42½	letter width b/b/f & f/f pedestals*	9135	10230	475
	CDCRTR-3484-AB	33½	84	42½	letter width b/b/f & f/f pedestals	9454	10660	509
	CDCRTR-3496-CD	33½	96	42½	legal width b/b/f & f/f pedestals	9776	11088	544
Racetrack transaction top					*note: narrow kneespace LE includes 2½" h metal base & 3/16" metal transaction top inlay			

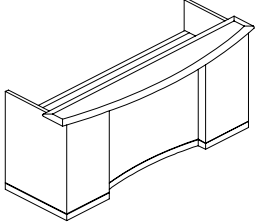
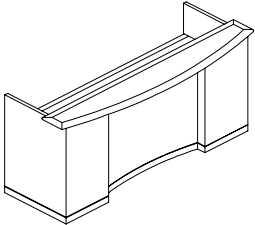
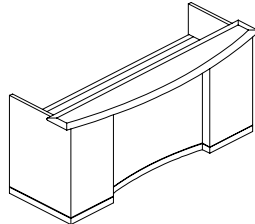
Description	Model Number	Overall Dimensions (in.)			Notes	Price (US\$)		Weight (lbs.)
		Depth	Width	Height		Standard	LE	
Reception Desk Enclosure w/ Concave Stepped Modesty 	CDDRTRF-3472	34	72	42½		6175	7272	351
	CDDRTRF-3484	34	84	42½		6537	7742	395
	CDDRTRF-3496	34	96	42½		6901	8216	439
Bowfront transaction top		<i>LE includes 2½" metal base & 3/16" metal transaction top inlay</i>						
Single Pedestal Reception Desk w/ Concave Stepped Modesty 	CDDRTRF-3472-AR	34	72	42½	letter width b/b/f pedestal	7644	8741	431
	CDDRTRF-3484-AR	34	84	42½	letter width b/b/f pedestal	8006	9211	475
	CDDRTRF-3496-CR	34	96	42½	legal width b/b/f pedestal	8370	9685	519
Bowfront transaction top		Specify Left or Right (seated)			<i>LE includes 2½" metal base & 3/16" metal transaction top inlay</i>			
Double Pedestal Reception Desk w/ Concave Stepped Modesty 	CDDRTRF-3472-AB	34	72	42½	letter width b/b/f & f/f pedestals	9112	10207	511
	CDDRTRF-3484-AB	34	84	42½	letter width b/b/f & f/f pedestals	9475	10681	555
	CDDRTRF-3496-CD	34	96	42½	legal width b/b/f & f/f pedestals	9839	11151	599
Bowfront transaction top		<i>LE includes 2½" metal base & 3/16" metal transaction top inlay</i>						

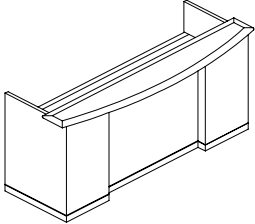
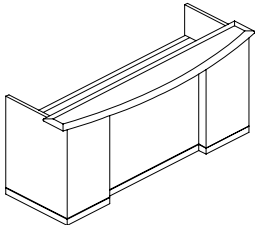
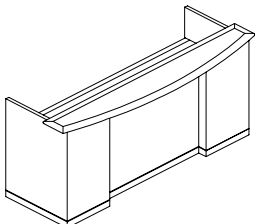
Description	Model Number	Overall Dimensions (in.)			Notes	Price (US\$)		Weight (lbs.)
		Depth	Width	Height		Standard	LE	
Reception Desk Enclosure w/ Straight Stepped Modesty 	CDSRTF-3472	34	72	42½	57½" w kneespace	5833	6930	351
	CDSRTF-3484	34	84	42½	69½" w kneespace	6195	7400	395
	CDSRTF-3496	34	96	42½	81½" w kneespace	6560	7874	439
Bowfront transaction top		<i>LE includes 2½" h metal base & 3/16" metal transaction top inlay</i>						
Single Pedestal Reception Desk w/ Straight Stepped Modesty 	CDSTRF-3472-AR	34	72	42½	letter width b/b/f pedestal	7303	8399	431
	CDSTRF-3484-AR	34	84	42½	letter width b/b/f pedestal	7665	8869	475
	CDSTRF-3496-CR	3	96	42½	legal width b/b/f pedestal	8029	9344	519
Bowfront transaction top		Specify Left or Right (seated)			<i>LE includes 2½" h metal base & 3/16" metal transaction top inlay</i>			
Double Pedestal Reception Desk w/ Straight Stepped Modesty 	CDSRTF-3472-AB	34	72	42½	letter width b/b/f & f/f pedestals	8771	9866	511
	CDSRTF-3484-AB	34	84	42½	letter width b/b/f & f/f pedestals	9133	10338	555
	CDSRTF-3496-CD	34	96	42½	legal width b/b/f & f/f pedestals	9497	10808	599
Bowfront transaction top		<i>LE includes 2½" h metal base & 3/16" metal transaction top inlay</i>						

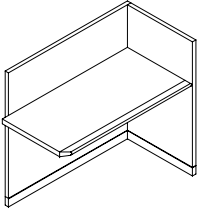
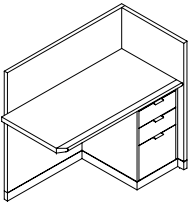
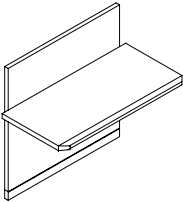
Description	Model Number	Overall Dimensions (in.)			Notes	Price (US\$)		Weight (lbs.)
		Depth	Width	Height		Standard	LE	
Reception Desk Return Enclosure	CR0R-2436- R	24	39¼	41¼		2756	2862	103
	CR0R-2442- R	24	45¼	41¼		2920	3037	116
								
Executive height worksurface Specify Left or Right (seated)	(R ight indicated)				<i>LE includes 2½" h metal base</i>			
Reception Desk Return w/ Pedestal	CR0R-2436- AR	24	39¼	41¼	letter width b/b/f pedestal	4228	4334	183
	CR0R-2442- AR	24	45¼	41¼	letter width b/b/f pedestal	4389	4506	196
								
Executive height worksurface Specify Left or Right (seated)	(R ight indicated)				<i>LE includes 2½" h metal base</i>			
Reception Desk Bridge	CB0R-2442	24	46	41¼		2105	2162	86
	CB0R-2448	24	52	41¼		2267	2332	99
	CB0R-2454	24	58	41¼		2432	2505	111
								
					<i>LE includes 2½" h metal base</i>			

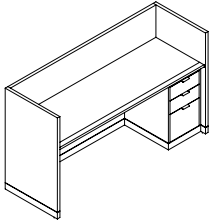
Description	Model Number	Overall Dimensions (in.)			Notes	Price (US\$)		Weight (lbs.)
		Depth	Width	Height		Standard	LE	
	CC0R-2260-AR	22	60	41¼	letter width b/b/f pedestal right	5625	5847	253
	CC0R-2272-CR	22	72	41¼	legal width b/b/f pedestal right	5960	6214	277
	CC0R-2284-CR	22	84	41¼	legal width b/b/f pedestal right	6286	6573	301
	CC0R-2760-AR	27	60	41¼	letter width b/b/f pedestal right	5852	6088	276
	CC0R-2772-CR	27	72	41¼	letter width b/b/f pedestal right	6194	6461	302
	CC0R-2784-CR	27	84	41¼	legal width b/b/f pedestal right	6526	6826	328

Specify Left or Right (right shown)

LE includes 2½" h metal base

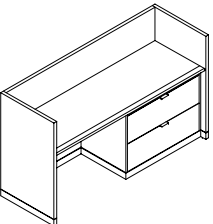
	CC0R-2260-ER	22	60	41¼	30" w lateral file right	5908	6130	273
	CC0R-2272-FR	22	72	41¼	36" w lateral file right	6241	6496	297
	CC0R-2284-FR	22	84	41¼	36" w lateral file right	6568	6856	321
	CC0R-2760-ER	27	60	41¼	30" w lateral file right	6135	6370	296
	CC0R-2772-FR	27	72	41¼	36" w lateral file right	6476	6744	322
	CC0R-2784-FR	27	84	41¼	36" w lateral file right	6812	7112	348

Specify Left or Right (right shown)

LE includes 2½" h metal base

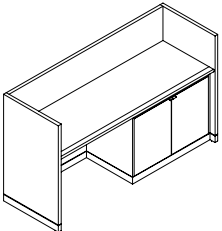
	CC0R-2260-HHR	22	60	41¼	30" w hinged door right	5625	5848	233
	CC0R-2272-HHR	22	72	41¼	36" w hinged door right	5963	6217	257
	CC0R-2284-HHR	22	84	41¼	36" w hinged door right	6286	6573	281
	CC0R-2760-HHR	27	60	41¼	30" w hinged door right	5851	6087	256
	CCOR-2772-HHR	27	72	41¼	36" w hinged door right	6192	6461	282
	CCOR-2784-HHR	27	84	41¼	36" w hinged door right	6525	6826	308

Specify Left or Right (right shown)

LE includes 2½" h metal base

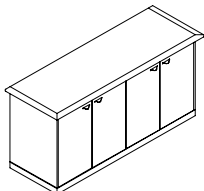
Description	Model Number	Overall Dimensions (in.)			Notes	Price (US\$)		Weight (lbs.)
		Depth	Width	Height		Standard	LE	
	CC0V-2172-HHHH	21	72	36	2 bays, 4 hinged doors	5735	6255	227
	CC0V-2184-HHHH	21	84	36	2 bays, 4 hinged doors	5946	6514	244
	CC0V-2196-HHHHHH	21	96	36	3 bays, 6 hinged doors	7284	7910	282
	CC0V-2672-HHHH	26	72	36	2 bays, 4 hinged doors	5866	6417	239
	CC0V-2684-HHHH	26	84	36	2 bays, 4 hinged doors	6083	6687	259
	CC0V-2696-HHHHHH	26	96	36	3 bays, 6 hinged doors	7426	8087	299

2 adjustable shelves behind each pair of hinged doors

LE includes 2½" h metal base & 3/16" metal top inlay

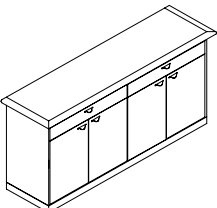
	CC0V-2172-GGGG	21	72	36	2 bays, 4 hinged doors	6360	6875	237
	CC0V-2184-GGGG	21	84	36	2 bays, 4 hinged doors	6566	7139	254
	CC0V-2196-GGGGGG	21	96	36	3 bays, 6 hinged doors	8131	8760	292
	CC0V-2672-GGGG	26	72	36	2 bays, 4 hinged doors	6487	7035	249
	CC0V-2684-GGGG	26	84	36	2 bays, 4 hinged doors	6701	7305	269
	CC0V-2696-GGGGGG	26	96	36	3 bays, 6 hinged doors	8274	8936	309

Single 6" box drawer above each pair of hinged doors
1 adjustable shelf behind each pair of hinged doors

LE includes 2½" h metal base & 3/16" metal top inlay

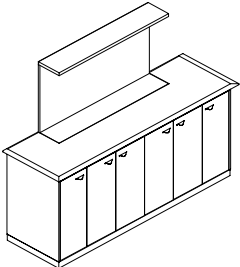
	CC0Y-2984	29	84	40	accommodates 42" plasma display	15002	15628	380
	CC0Y-2996	29	96	40	accommodates 54" plasma display	16527	17211	417
					2 full depth outside hinged door compartments 14½" deep equipment shelves behind center doors with wire access to plasma display			
Plasma lift remote control included					LE includes 2½" h metal base			

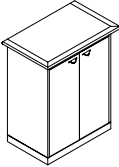
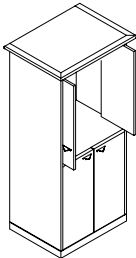
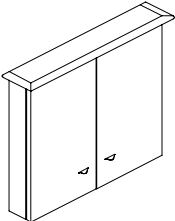
Description	Model Number	Overall Dimensions (in.)			Notes	Price (US\$)		Weight (lbs.)
		Depth	Width	Height		Standard	LE	
	CVH002-263443	26	34	42½	2 hinged doors	3494	3821	193
	CVH002-264043	26	40	42½	2 hinged doors	3760	4105	216
	CVH0C2-263443	26	34	42½	2 hinged doors with casters	3676	4000	193
	CVH0C2-264043	26	40	42½	2 hinged doors with casters	3904	4251	213
2 adjustable shelves standard					(note: no lock standard) LE includes 2½" h metal base & 3/16" metal top inlay			
	CVHR02-263468-0-VS2	26	34	64	2 upper retractable doors 2 lower hinged doors	5716	5832	307
	CVHR02-264068-0-VS2	26	40	64	2 upper retractable doors 2 lower hinged doors	6006	6130	333
2 adjustable shelves standard 2 ventilation slots					LE includes 2½" h metal base			
	CVDH-4839	12	52	40¼		3145	3145	132
	CVDH-5439	12	58	40¼		3465	3465	148
	CVDH-6039	12	64	40¼		3639	3639	165
	CVDH-6639	12	70	40¼		3811	3811	181
Fabric panels inside of doors					LE includes enhanced metal access hardware.			

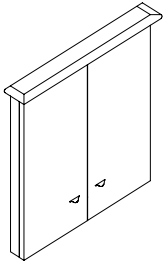
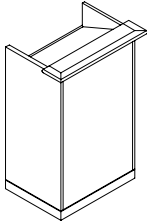
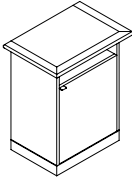
Description	Model Number	Overall Dimensions (in.)			Notes	Price (US\$)		Weight (lbs.)
		Depth	Width	Height		Standard	LE	
Hinged Door Presentation Board 	CVBH-4848	8	52	49¼		3252	3252	143
	CVBH-6048	8	64	49¼		3730	3730	179
Fabric panels inside of doors Dry Erase writing surface interior		LE includes enhanced metal access hardware						
Podium 	CVP-2130	21	30	42½		2987	3084	111
	CVP-2136	21	36	42½		3236	3343	123
Sloped speakers' shelf Fixed shelf in kneespace		LE includes 2½" h metal base						
Telephone Cabinet 	CVC-1624	16	24	29	4" h open phonebook shelf	2066	2293	68
		LE includes 2½" h metal base & 3/16" metal top inlay						

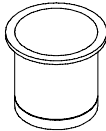
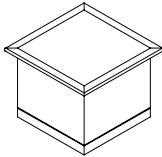
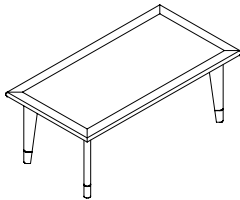
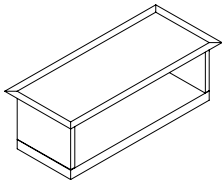
Description	Model Number	Overall Dimensions (in.)			Notes	Price (US\$)		Weight (lbs.)
		Depth	Width	Height		Standard	LE	
	CTD-181818	18	18	18		1188	1537	78
	CTD-222220	22	22	20		1450	1851	92
	CTD-282816	28	28	16		1492	1972	104
	CTD-343416	34	34	16		2327	2880	137
<i>LE includes 2½" h metal base & 3/16" metal top inlay</i>								
	CTC-222220	22	22	20		1394	1770	80
	CTC-223220	22	32	20		1580	2019	109
	CTC-323220	32	32	20		1775	2281	146
<i>LE includes 2½" h metal base & 3/16" metal top inlay</i>								
	CTS4L-203616	20	36	16		2520	2823	44
	CTS4L-204216	20	42	16		2580	2906	49
	CTS4L-204816	20	48	16		2643	2991	53
	CTS4L-203020	20	30	20		2492	2770	42
	CTS4L-303020	30	30	20		2598	2914	53
Diagonal tapered legs		<i>LE includes 3/16" metal top inlay</i>						
	CTS2B-204216	20	42	16		1721	2213	69
	CTS2B-204816	20	48	16		1790	2326	76
Full bottom shelf connects panels		<i>LE includes 2½" h metal base & 3/16" metal top inlay</i>						