

CONFIGURATION EXAMPLES

Description

Model Number

**Price
(US\$)**

**Weight
(lbs.)**

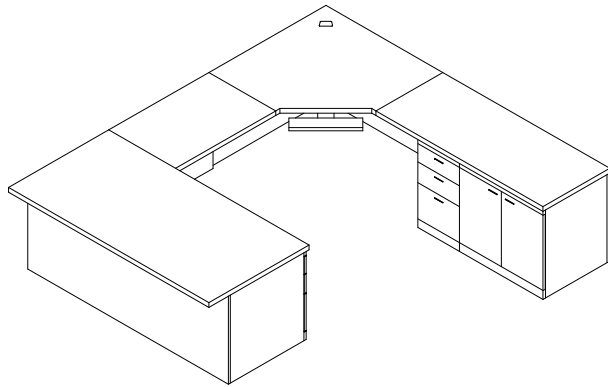

Configuration (edge profile **q** indicated)
overall dimension 102"D x 114"W x 29¼"H

Components:

Single Pedestal Desk	qD0-3672-CL	3290	253
Bridge	qB000L-2436	1059	65
Corner Bridge	qBC0-4242	2202	225
Adjustable Keyboard Tray	AKTW-22	378	
Large Black Grommet	AGR-BL	65	
Return	qR000L-2460-CR	2423	165
Additional HH Pedestal	xPHH3-2430	<u>1208</u>	<u>60</u>
	Total:	10625	768

Configuration (edge profile **m** indicated)
overall dimension 72"D x 129"W x 70½"H

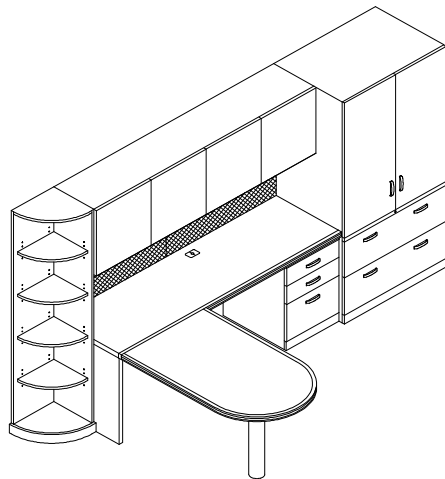

Components:

Single Pedestal Credenza	mC000K-2478-CR	2583	180
Large Black Grommet	AGR- BL	65	
Racetrack Runoff Desk	mDRUIN-3048	1465	60
Hinged Door High-Rise Storage	xSUH20-1578	2711	177
Tackboard	ATBF-78	422	
Bend Shelving for High-Rise	xSE0140L-141471	1930	76
Combination File/ Storage	xSSU122-253671	<u>4263</u>	<u>317</u>
		13439	810

CONFIGURATION EXAMPLES

Description

Model Number

**Price
(US\$)**

**Weight
(lbs.)**

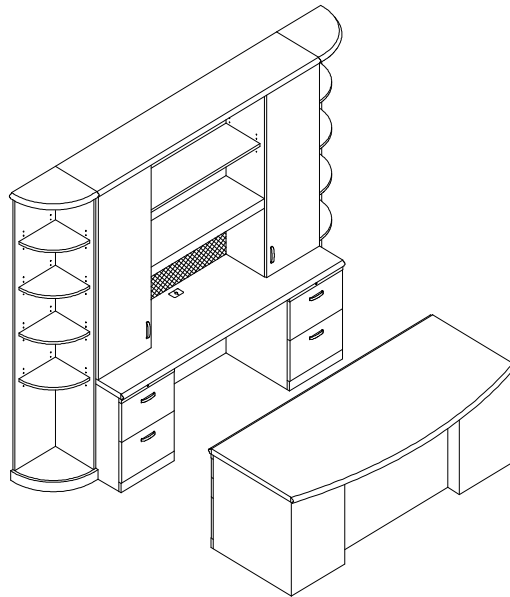

Configuration (edge profile **g** indicated)
overall dimension 108"W x 82½"H

Components:

Bow Top Double Pedestal Desk	gDB00S-3678-CD	4575	303
Center Drawer	ACD-21	244	
Bend Shelving for High Rise	xSE0150L-141483	2222	88
Top Cap with Edge Profile	gWCF1A-1515	240	8
Double Pedestal Credenza	gC000L-2478-DKD	3763	271
Large Black Grommet	AGR-BL	65	
Split Storage Hi-Rise	xSUI332	4167	332
Tackboard	ATBF-42	227	
Top Cap	gWCF1-1678	515	43
Bend Shelving for High Rise	xSE0150R-141483	2222	88
Curved Overlay Top Detail	gWCF1A-1515	240	8
		<hr/>	<hr/>
		18480	1141

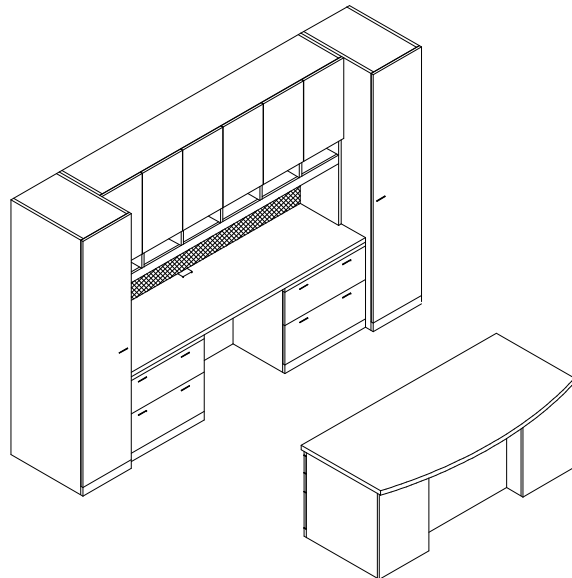

Configuration (edge profile **s** indicated)
overall dimension 122"W x 82½ "H

Components:

Bow Top Double Pedestal Desk	sDB00S-3678-CD	4575	303
Hinged Door Storage w/ 5 Shelves	xSHU15-251683-L	3179	186
Credenza w/ 2 Lateral Files	sC000L-2490-EKE	4457	328
Large Black Grommet	AGR-BL	65	
Hi-Rise w/ Doors & Organizer	xSUD31-1590	4665	321
Tackboard	ATBF-90	487	
Tasklights	ATL-48	216	
Wardrobe	xSCU11- 251683-R	2306	172
		<hr/>	<hr/>
		Total:	19950 1310

CONFIGURATION EXAMPLES

Description

Model Number

Price
(US\$)

Weight
(lbs.)

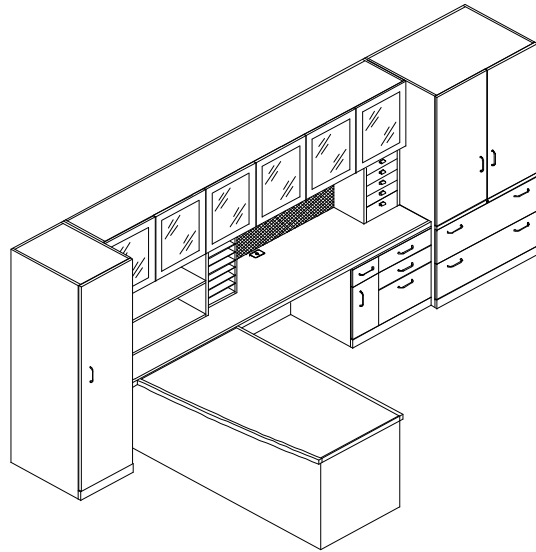

Configuration (edge profile **q** indicated)
overall dimension 84"D x 151"W x 70½"H

Components:

Hinged Door Storage	xSHU14-251971-L	2849	178
Arc Front Runoff Desk with Single Pedestal	qDHU-3660-AL	3086	190
Credenza with Single Pedestal	qC000L-2496-CR	3336	251
Mini Pedestal-1 Box Drawer over Hinged Door	xPg03-249	945	50
Spanner Storage with Metal Framed Glass Doors	xSWH300A-1596	5305	212
Bookcase	xSBU11-143620	967	58
Upper Storage Organizer	xSPS-1211	717	28
Tackboard	ATBF-60	326	
Upper Storage Organizer	xSPJ-1211	1034	31
Combination File/Storage	xSSU122-253671	<u>4263</u>	<u>317</u>
Total:		22828	1315

Configuration (edge profile **g** indicated)
overall dimension 57"D x 102¾"W x 70½"H

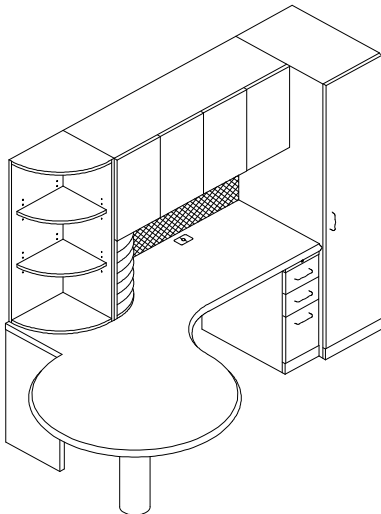

Components:

Eddy Runoff Worksurface w/ Grommet	gDEUH-5784-L-GL1	3187	181
Keel	xWM2-1783	339	5
“L” Endpanel	xWE2-2210-L	418	35
Bend Shelving, Desktop	xSPE160-121220	845	30
Bend Shelving, High Rise	xSET120L-141441	1201	43
Wall Mount/Spanner Storage w/ Doors	xSWH21-1548	2458	142
Tackboard	ATBF-48	259	
Mini Pedestal- 2box, 1 File Drawers	xPa03-249	1050	80
Wardrobe	xSCU11-251971-R	<u>2184</u>	<u>166</u>
Total:		11941	682

CONFIGURATION EXAMPLES

Description

Model Number

Price (US\$) **Weight (lbs.)**

Configuration (edge profile **s** indicated)

Overall Dimensions: 132"D x 96"W x 29¼"H

Components:

Bend Worksurface	sWT11A-3030-L	860	31
Bend Pedestal with Shelves	xSEI110L-2929	1559	98
Flow Worksurface - N with Grommet	sWT11N-3060-R-GL1	1316	63
Lateral File Pedestal	xPF03-2436	1365	100
Mini Pedestal - 2 box, 1 file	xPa03-249	1050	80
Cove Corner Worksurface with Grommet	sBC0BTD-4242-0-GL1	1219	61
Bracing Legs (2)	xWL2N0A-12	962	24
Eddy Runoff Worksurface with Grommet	sDEUH-5754-R-GL1	2676	122
Perimeter Wall Mount Kit (14')	AMWB-168	294	
Wall Mount End Cap	AMWB-CAP	40	

Total: 11341 579

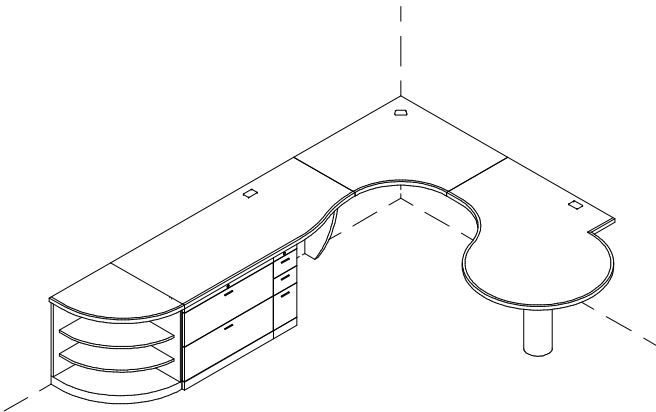

Configuration (edge profile **r** indicated)

Overall Dimensions: 72"D x 93"W x 53¼"H

Components:

Flow worksurface - M- w/ Grommet	rWT11M-3072-L-GL1	1500	75
Keel	xWM2-1723	326	5
"L" End Panel	xWE2-2810	444	41
Droplet Runoff Worksurface	rDQUH-4242-L	1915	76
Upper Storage Organizer (2)	xSPS-1216	1785	74
Tackboard	ATBF-40	215	
Sort Wing	xSPW5-12724	984	38
Pedestal - 2 Box, 1 File Drawers	xPA03-2416	1103	80

8272 389

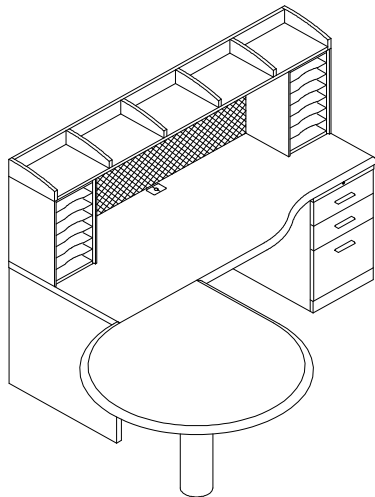

CONFIGURATION EXAMPLES

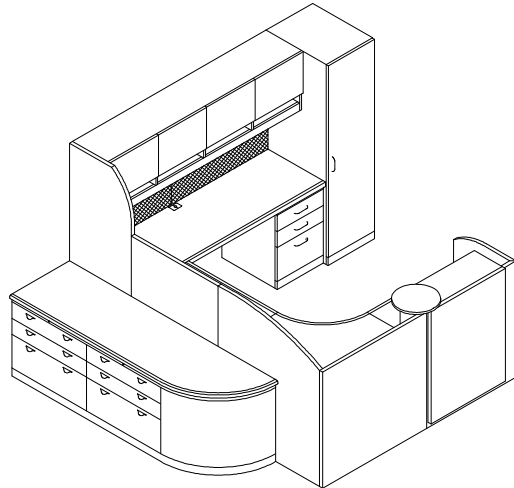

Description

Model Number

**Price
(US\$)**

**Weight
(lbs.)**

Configuration (edge profile **s** indicated)
 overall dimension"103'D x 112¼"W x 70½"H
 Components:

Wardrobe	xSCU11-251971-L	2184	166
Workstation "L" End Panel w/ Arched Front	xWE20A-251771-R	910	96
Worksurface	q WT11S-2472	970	60
Large Black Grommet	AGR-BL	65	
Pedestal	xPC03-2419	1103	80
Spanner Storage w/ Doors & Organizer	xSWD20-1572	2735	150
Tackboard	ATBF-72	390	
Workstation Bridge with Grommet	xBOR-243651-0-GL1	1379	94
Workstation Corner Bridge w/ Arc Transition	xBCAB0D-424251-R-GL1	3400	353
Gallery Return Shell w/ Arc Transition at end	xRAR-243641-R-GL1	1927	115
Applied Anigre Feature Front	xSPIX-1271	3281	90
Pedestal- Lateral File, 2 Box Drawers (2)	xPT03-2030	2835	200
Bend-Pedestal-Curved Front	xSE000SR-1919	1403	72
Bend Worksurface	sWT11A-2080	1405	56

Organizer on Seated Side of Panel
 Mini Transaction Shelf

(note: Gallery Desk Worksurface
 are only available with square edge detail)

Total: 23991 1532

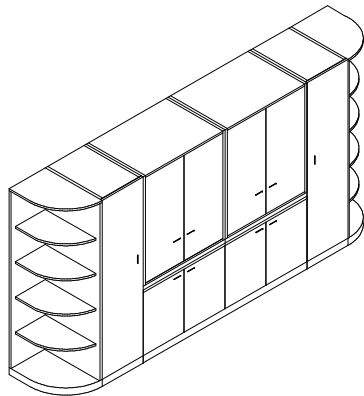

Configuration (edge profile **m** indicated)
 overall dimension 25"D x 140"W x 70½"H

Components:

Bend Shelving	xSE0140L-241471	2297	126
Hinged Door Storage	xSHU14-251971-L	2849	178
Full Storage Credenza	m C000K-2072-HHHH	2729	170
Upper Storage Video Cabinet (2) With Full Height Retractable Doors	xSUT10R-253641	6098	368
Hinged Door Storage	xSHU14-251971-R	2849	178
Bend Shelving	xSE0140R-241471	2297	126

Total: 19119 1146

Shown with retractable doors closed

CONFIGURATION EXAMPLES

Description

Model Number

Price (US\$) **Weight (lbs.)**

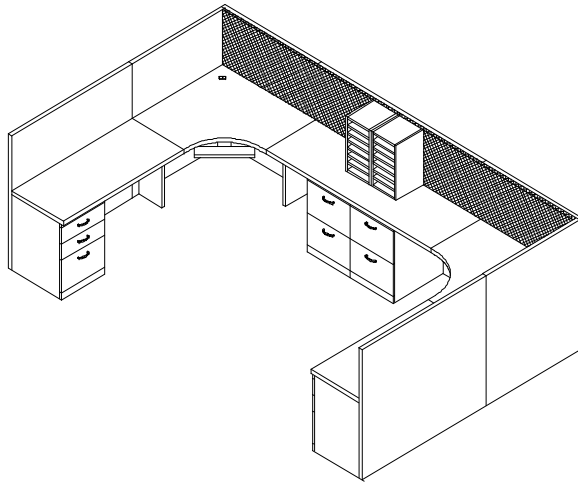

Configuration (edge profile **q** indicated)
overall dimension 72"D x 120"W x 50½"H

Components:

Workstation Return w/ Grommet	xR0R-243651-L-GL1	1910	136
Pedestal - 2 Box, 1 File Drawers	xPC03-2419	1103	80
Workstation Corner Bridge with Grommet	xBCRB0D-363651-0-GL1	2752	295
Articulating Keyboard Tray	AKTW-22	368	
Workstation Bridge with Grommet	xB0R-244851-0-GL1	1618	125
Pedestal-2 File Drawers (2)	xPD03-2419	2205	160
Upper Storage Organizer (2)	xSPS-1211	1434	56
Workstation Corner Bridge with Grommet	xBCRB0D-363651-0-GL1	2752	295
Articulating Keyboard Tray	AKTW-22	378	
Workstation Return with Grommet	xR0R-243651-R-GL1	1910	136
Pedestal-2 box, 1 File Drawer	xPC03-2419	1103	80
Tackboard	ATBF-42	651	
		18194	1363
	Total:		

(note: Workstation and Gallery Desk worksurfaces are only available with square edge detail.)

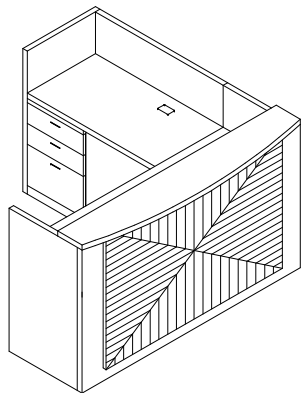

Configuration (edge profile **a** indicated)
overall dimension 72"D x 74½"W x 42¾"H

Components:

Gallery Desk w/ Single Pedestal	xD0R-2472-CR-GL2	4055	311
Applied Feature Front #III - 58"w	1WFIII-15838	2968	46
Bow Front Overlay Transaction Top	aWA11F-1472	469	35
Gallery Desk Return w/ Single Pedestal with Grommet	xR0R-2442-AL-GL1	1966	209
		10458	601
	Total:		

(note: Workstations and Gallery Desk worksurfaces are only available with square edge detail. Detail may however be added to the transaction top leading visitor side edge)

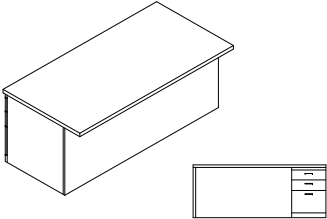
Description	Model Number	Overall Dimensions (in.)			Notes	Price (US\$)	Weight (lbs.)
		Depth	Width	Height			
	_D0-3066-AR	30	66	29¼	letter width b/b/f pedestal, 6" overhang	3009	222
	_D0-3072-CR	30	72	29¼	legal width b/b/f pedestal, 6" overhang	3113	232
	_D0-3078-CR	30	78	29¼	legal width b/b/f pedestal, 6" overhang	3204	242
	_D0-3084-CR	30	84	29¼	legal width b/b/f pedestal, 6" overhang	3296	252
	_D0-3672-CR	36	72	29¼	legal width b/b/f pedestal, 6¾" overhang	3290	253
	_D0-3678-CR	36	78	29¼	legal width b/b/f pedestal, 6¾" overhang	3387	264
	_D0-3684-CR	36	84	29¼	legal width b/b/f pedestal, 6¾" overhang	3482	275

Straight front full overhang
Specify **Left** or **Right** (seated) **(Right indicated)**

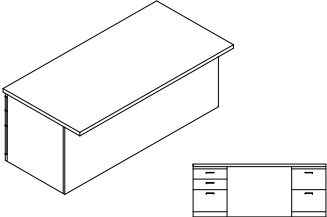
	_D0-3066-AB	30	66	29¼	letter width b/b/f & f/f pedestals, 6" overhang	3694	267
	_D0-3072-CD	30	72	29¼	legal width b/b/f & f/f pedestals, 6" overhang	3798	277
	_D0-3078-CD	30	78	29¼	legal width b/b/f & f/f pedestals, 6" overhang	3887	287
	_D0-3084-CD	30	84	29¼	legal width b/b/f & f/f pedestals, 6" overhang	3980	297
	_D0-3672-CD	36	72	29¼	legal width b/b/f & f/f pedestals, 6¾" overhang	3998	292
	_D0-3678-CD	36	78	29¼	legal width b/b/f & f/f pedestals, 6¾" overhang	4097	303
	_D0-3684-CD	36	84	29¼	legal width b/b/f & f/f pedestals, 6¾" overhang	4194	314

Straight front full overhang

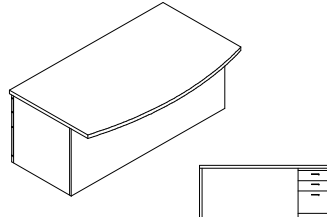
	_DB-3666-AR	30/36	66	29¼	letter width b/b/f pedestal, 12" overhang	3440	236
	_DB-3672-CR	30/36	72	29¼	legal width b/b/f pedestal, 12" overhang	3565	247
	_DB-3678-CR	30/36	78	29¼	legal width b/b/f pedestal, 12" overhang	3673	258
	_DB-3684-CR	30/36	84	29¼	legal width b/b/f pedestal, 12" overhang	3785	269
	_DB-4272-CR	36/42	72	29¼	legal width b/b/f pedestal, 12¾" overhang	3756	268
	_DB-4278-CR	36/42	78	29¼	legal width b/b/f pedestal, 12¾" overhang	3871	280
	_DB-4284-CR	36/42	84	29¼	legal width b/b/f pedestal, 12¾" overhang	3985	292

Straight front full overhang
Specify **Left** or **Right** (seated) **(Right indicated)**

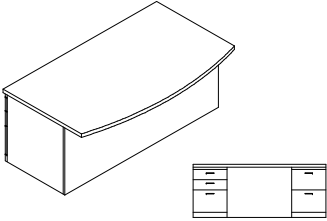
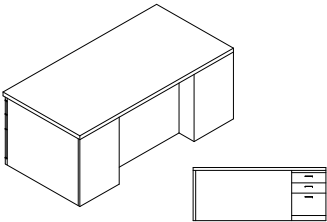
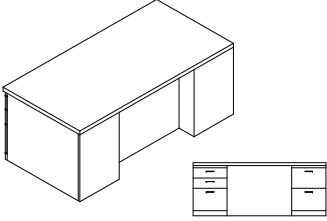
Description	Model Number	Overall Dimensions (in.)			Notes	Price (US\$)	Weight (lbs.)
		Depth	Width	Height			
	_DB-3666-AB	30/36	66	29¼	letter width b/b/f & f/f pedestals, 12" overhang	4123	281
	_DB-3672-CD	30/36	72	29¼	legal width b/b/f & f/f pedestals, 12" overhang	4246	292
	_DB-3678-CD	30/36	78	29¼	legal width b/b/f & f/f pedestals, 12" overhang	4356	303
	_DB-3684-CD	30/36	84	29¼	legal width b/b/f & f/f pedestals, 12" overhang	4469	314
	_DB-4272-CD	36/42	72	29¼	legal width b/b/f & f/f pedestals, 12¾" overhang	4465	307
	_DB-4278-CD	36/42	78	29¼	legal width b/b/f & f/f pedestals, 12¾" overhang	4580	319
	_DB-4284-CD	36/42	84	29¼	legal width b/b/f & f/f pedestals, 12¾" overhang	4694	332
	Straight front full overhang						
	_D000S-3066-AR	30	66	29¼	letter width b/b/f pedestal	3200	228
	_D000S-3072-CR	30	72	29¼	legal width b/b/f pedestal	3304	238
	_D000S-3078-CR	30	78	29¼	legal width b/b/f pedestal	3397	248
	_D000S-3084-CR	30	84	29¼	legal width b/b/f pedestal	3489	257
	_D000S-3672-CR	36	72	29¼	legal width b/b/f pedestal	3486	259
	_D000S-3678-CR	36	78	29¼	legal width b/b/f pedestal	3582	270
	_D000S-3684-CR	36	84	29¼	legal width b/b/f pedestal	3679	281
	Recessed center modesty panel Specify Left or Right (seated) (Right indicated)						
	_D000S-3066-AB	30	66	29¼	letter width b/b/f & f/f pedestals	3912	267
	_D000S-3072-CD	30	72	29¼	legal width b/b/f & f/f pedestals	4016	277
	_D000S-3078-CD	30	78	29¼	legal width b/b/f & f/f pedestals	4106	287
	_D000S-3084-CD	30	84	29¼	legal width b/b/f & f/f pedestals	4198	297
	_D000S-3672-CD	36	72	29¼	legal width b/b/f & f/f pedestals	4224	292
	_D000S-3678-CD	36	78	29¼	legal width b/b/f & f/f pedestals	4320	303
	_D000S-3684-CD	36	84	29¼	legal width b/b/f & f/f pedestals	4416	314
	Recessed center modesty panel						

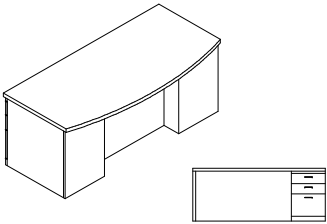
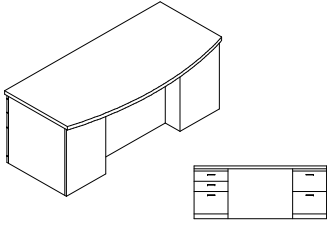
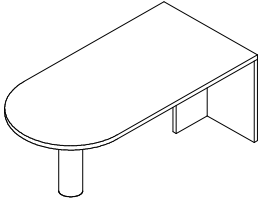
Description	Model Number	Overall Dimensions (in.)			Notes	Price (US\$)	Weight (lbs.)	
		Depth	Width	Height				
	_DB00S-3666-AR	30/36	66	29¼	letter width b/b/f pedestal, 6" overhang	3633	242	
	_DB00S-3672-CR	30/36	72	29¼	legal width b/b/f pedestal, 6" overhang	3755	253	
	_DB00S-3678-CR	30/36	78	29¼	legal width b/b/f pedestal, 6" overhang	3866	264	
	_DB00S-3684-CR	30/36	84	29¼	legal width b/b/f pedestal, 6" overhang	3975	275	
	_DB00S-4272-CR	36/42	72	29¼	legal width b/b/f pedestal, 6" overhang	3950	274	
	_DB00S-4278-CR	36/42	78	29¼	legal width b/b/f pedestal, 6" overhang	4068	286	
	_DB00S-4284-CR	36/42	84	29¼	legal width b/b/f pedestal, 6" overhang	4181	298	
Recessed center modesty Specify Left or Right (seated)	(Right indicated)							
	_DB00S-3666-AB	30/36	66	29¼	letter width b/b/f & f/f pedestals, 6" overhang	4342	281	
	_DB00S-3672-CD	30/36	72	29¼	legal width b/b/f & f/f pedestals, 6" overhang	4467	292	
	_DB00S-3678-CD	30/36	78	29¼	legal width b/b/f & f/f pedestals, 6" overhang	4575	303	
	_DB00S-3684-CD	30/36	84	29¼	legal width b/b/f & f/f pedestals, 6" overhang	4687	314	
	_DB00S-4272-CD	36/42	72	29¼	legal width b/b/f & f/f pedestals, 6" overhang	4688	307	
	_DB00S-4278-CD	36/42	78	29¼	legal width b/b/f & f/f pedestals, 6" overhang	4803	319	
	_DB00S-4284-CD	36/42	84	29¼	legal width b/b/f & f/f pedestals, 6" overhang	4919	332	
Recessed center modesty								
	_DR0IN-3066	30	66	29¼		2064	120	
	_DR0IN-3072	30	72	29¼		2137	126	
	_DR0IN-3078	30	78	29¼		2196	132	
	_DR0IN-3084	30	84	29¼		2256	138	
	_DR0IN-3090	30	90	29¼		2392	145	
	_DR0IN-3096	30	96	29¼		2456	151	
	_DR0IN-3666	36	66	29¼		2170	139	
	_DR0IN-3672	36	72	29¼		2249	147	
	_DR0IN-3678	36	78	29¼		2313	154	
	_DR0IN-3684	36	84	29¼		2375	162	
	With "T" end panel and 4" post leg	_DR0IN-3690	36	90	29¼		2519	169
	Specify chrome or black leg	_DR0IN-3696	36	96	29¼		2587	177

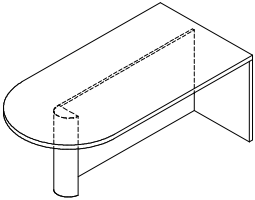
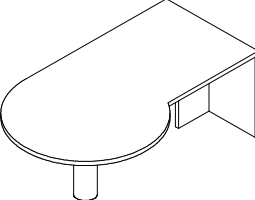
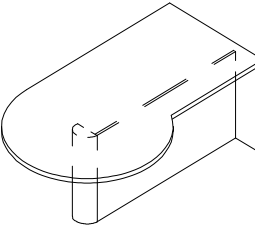
Description	Model Number	Overall Dimensions (in.)			Notes	Price (US\$)	Weight (lbs.)
		Depth	Width	Height			
 <p>Peninsula Desk</p>	_DR0UL-3066-R	30	66	29¼		2914	191
	_DR0UL-3072-R	30	72	29¼		3025	203
	_DR0UL-3078-R	30	78	29¼		3127	216
	_DR0UL-3084-R	30	84	29¼		3228	228
	_DR0UL-3090-R	30	90	29¼		3326	240
	_DR0UL-3096-R	30	96	29¼		3427	252
	_DR0UL-3666-R	36	66	29¼		3022	208
	_DR0UL-3672-R	36	72	29¼		3138	221
	_DR0UL-3678-R	36	78	29¼		3245	235
	With end panel, full modesty and 16" split drum leg Specify Left or Right	_DR0UL-3684-R	36	84	29¼		3350
	_DR0UL-3690-R	36	90	29¼		3456	262
	_DR0UL-3696-R	36	96	29¼		3560	275
 <p>"P" Top Peninsula Desk</p>	_DP0HN-4272-R	30/42	72	29¼		2789	173
	_DP0HN-4278-R	30/42	78	29¼		2870	181
	_DP0HN-4284-R	30/42	84	29¼		2949	190
	_DP0HN-4290-R	30/42	90	29¼		3106	199
	_DP0HN-4296-R	30/42	96	29¼		3191	208
	_DP0HN-4878-R	36/48	78	29¼		2997	203
	_DP0HN-4884-R	36/48	84	29¼		3083	213
	_DP0HN-4890-R	36/48	90	29¼		3241	223
	_DP0HN-4896-R	36/48	96	29¼		3330	233
	With "T" end panel, and 6" post leg Specify chrome or black leg Specify Left or Right (seated)						
 <p>"P" Top Peninsula Desk</p>	_DP0UL-4272-R	30/42	72	29¼		3516	239
	_DP0UL-4278-R	30/42	78	29¼		3640	254
	_DP0UL-4284-R	30/42	84	29¼		3758	268
	_DP0UL-4290-R	30/42	90	29¼		3880	283
	_DP0UL-4296-R	30/48	96	29¼		3998	298
	_DP0UL-4878-R	36/48	72	29¼		3642	257
	_DP0UL-4878-R	36/48	78	29¼		3766	273
	_DP0UL-4884-R	36/48	84	29¼		3894	289
	_DP0UL-4890-R	36/48	90	29¼		4018	305
	_DP0UL-4896-R	36/48	96	29¼		4141	321
With end panel, full modesty and 16" split drum leg Specify Left or Right (seated)							
	(Right indicated)						
					(unless otherwise specified, conferencing radius is on approach side of configuration)		

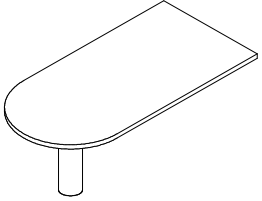
Description	Model Number	Overall Dimensions (in.)			Notes	Price (US\$)	Weight (lbs.)
		Depth	Width	Height			
	_DRUIN-3048	30	48	29¼		1465	60
	_DRUIN-3054	30	54	29¼		1526	66
	_DRUIN-3060	30	60	29¼		1581	73
	_DRUIN-3066	30	66	29¼		1643	79
	_DRUIN-3072	30	72	29¼		1713	85
	_DRUIN-3648	36	48	29¼		1537	70
	_DRUIN-3654	36	54	29¼		1599	78
	_DRUIN-3660	36	60	29¼		1662	85
	_DRUIN-3666	36	66	29¼		1726	93
	_DRUIN-3672	36	72	29¼		1803	100

4" post leg
Specify chrome or black leg

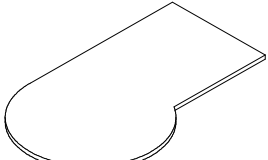
	_DPUHN-4266-R	30/42	66	29¼		2226	111
	_DPUHN-4272-R	30/42	72	29¼		2323	120
	_DPUHN-4278-R	30/42	78	29¼		2403	129
	_DPUHN-4866-R	36/48	66	29¼		2319	125
	_DPUHN-4872-R	36/48	72	29¼		2423	135
	_DPUHN-4878-R	36/48	78	29¼		2508	145

6" post leg
Specify chrome or black leg
Specify Left or Right

(Right indicated)

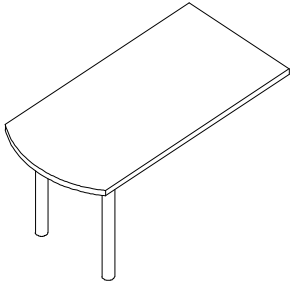
	_DWUIN-3048	30	48	29¼		1897	70
	_DWUIN-3054	30	54	29¼		1969	76
	_DWUIN-3060	30	60	29¼		2037	83
	_DWUIN-3066	30	66	29¼		2107	89
	_DWUIN-3072	30	72	29¼		2187	95
	_DWUIN-3648	36	48	29¼		1979	80
	_DWUIN-3654	36	54	29¼		2054	88
	_DWUIN-3660	36	60	29¼		2127	95
	_DWUIN-3666	36	66	29¼		2201	103
	_DWUIN-3672	36	72	29¼		2290	110

2 - 4" post legs
Specify chrome or black leg

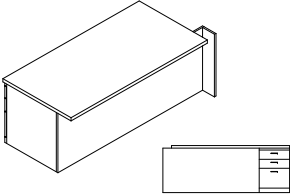
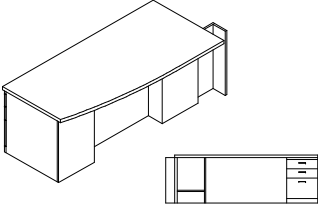
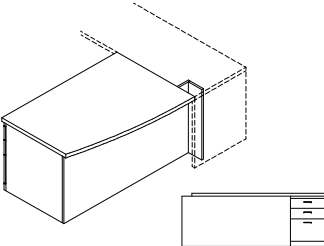
Description	Model Number	Overall Dimensions (in.)			Notes	Price (US\$)	Weight (lbs.)	
		Depth	Width	Height				
Runoff Desk 	_DU00L-3054-CR	30	54	29¼	legal width b/b/f pedestal	2532	168	
	_DU00L-3060-CR	30	60	29¼	legal width b/b/f pedestal	2618	178	
	_DU00L-3066-CR	30	66	29¼	legal width b/b/f pedestal	2711	187	
	_DU00L-3072-CR	30	72	29¼	legal width b/b/f pedestal	2670	197	
	_DU00L-3654-CR	36	54	29¼	legal width b/b/f pedestal	2814	179	
	_DU00L-3660-CR	36	60	29¼	legal width b/b/f pedestal	2766	190	
	_DU00L-3666-CR	36	66	29¼	legal width b/b/f pedestal	2861	201	
	_DU00L-3672-CR	36	72	29¼	legal width b/b/f pedestal	2967	212	
	Specify Left or Right (seated)	(Right indicated)						
	Arc Front Runoff Desk with Single Pedestal 	_DH00S-3672-CR	30/36	72	29¼	legal width b/b/f pedestal	3810	253
_DH00S-3678-CR		30/36	78	29¼	legal width b/b/f pedestal	3919	264	
_DH00S-3684-CR		30/36	84	29¼	legal width b/b/f pedestal	4012	273	
_DH00S-3690-CR		30/36	90	29¼	legal width b/b/f pedestal	4142	286	
Specify Left or Right (seated)		(Right indicated)						
Recessed center modesty panel Specify Left or Right (seated)								
	Arc Front Runoff Desk with Single Pedestal 	_DHU-3654-AR	30/36	54	29¼	letter width b/b/f pedestal	2976	179
		_DHU-3660-AR	30/36	60	29¼	letter width b/b/f pedestal	3086	190
		_DHU-3666-AR	30/36	66	29¼	letter width b/b/f pedestal	3195	201
Specify Left or Right (seated)	(Right indicated)							

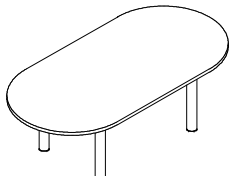
Description	Model Number	Overall Dimensions (in.)			Notes	Price (US\$)	Weight (lbs.)
		Depth	Width	Height			
 Racetrack Table w/ Legs	_TR4I-3060	30	60	29¼		2918	103
	_TR4I-3066	30	66	29¼		3019	109
	_TR4I-3072	30	72	29¼		3116	115
	_TR4I-3666	36	66	29¼		3306	123
	_TR4I-3672	36	72	29¼		3415	130
	_TR4I-3678	36	78	29¼		3812	138
	_TR4I-3684	36	84	29¼		3926	145
	_TR4I-4284	42	84	29¼		4247	163

4- 4" post legs
Specify chrome or black legs

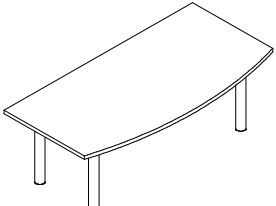
 Bowfront Table Desk	_TF4I-3666	30/36	66	29¼		2904	123
	_TF4I-3672	30/36	72	29¼		3052	130
	_TF4I-3678	30/36	78	29¼		3489	138
	_TF4I-3684	30/36	84	29¼		3640	145
	_TF4I-4266	36/42	66	29¼		3056	136
	_TF4I-4272	36/42	72	29¼		3215	145
	_TF4I-4278	36/42	78	29¼		3661	154
	_TF4I-4284	36/42	84	29¼		3825	163

4- 4" post legs
Specify chrome or black legs

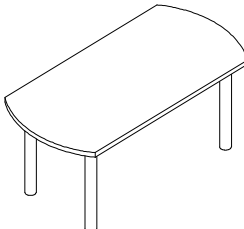
 Bow End Table Desk	_TW4I-3672	36	72	29¼		3389	130
	_TW4I-3678	36	78	29¼		3842	138
	_TW4I-3684	36	84	29¼		4015	145

4- 4" post legs
Specify chrome or black legs

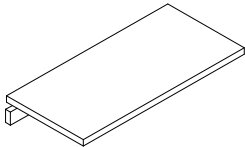
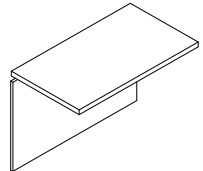
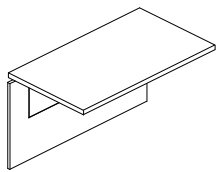
Description	Model Number	Overall Dimensions (in.)			Notes	Price (US\$)	Weight (lbs.)	
		Depth	Width	Height				
	_B000K-2030	20	30	29¼		605	21	
	_B000K-2036	20	36	29¼		657	25	
	_B000K-2042	20	42	29¼		714	29	
	_B000K-2048	20	48	29¼		770	33	
	_B000K-2054	20	54	29¼		825	38	
	_B000K-2060	20	60	29¼		880	42	
	_B000K-2430	24	30	29¼		645	25	
	_B000K-2436	24	36	29¼		702	30	
	_B000K-2442	24	42	29¼		759	35	
	_B000K-2448	24	48	29¼		821	40	
	_B000K-2454	24	54	29¼		877	45	
	Open back with solid wood keel	_B000K-2460	24	60	29¼		936	50
		_B000L-2030	20	30	29¼		915	50
		_B000L-2036	20	36	29¼		1006	60
_B000L-2042		20	42	29¼		1094	70	
_B000L-2048		20	48	29¼		1185	80	
_B000L-2054		20	54	29¼		1278	90	
_R000L-2060		20	60	29¼		1364	100	
_B000L-2430		24	30	29¼		964	54	
_B000L-2436		24	36	29¼		1059	65	
_B000L-2442		24	42	29¼		1150	76	
_B000L-2448		24	48	29¼		1244	87	
_B000L-2454		24	54	29¼		1339	98	
Full finished modesty panel		_B000L-2460	24	60	29¼		1431	108
		_B000H-2030	20	30	29¼		893	39
		_B000H-2036	20	36	29¼		975	47
	_B000H-2042	20	42	29¼		1057	55	
	_B000H-2048	20	48	29¼		1140	62	
	_B000H-2054	20	54	29¼		1224	70	
	_B000H-2060	20	60	29¼		1304	78	
	_B000H-2430	24	30	29¼		942	43	
	_B000H-2436	24	36	29¼		1029	52	
	_B000H-2442	24	42	29¼		1113	60	
	_B000H-2448	24	48	29¼		1199	69	
	_B000H-2454	24	54	29¼		1285	78	
	Hinged modesty panel	_B000H-2460	24	60	29¼		1372	86

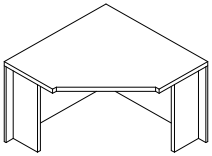
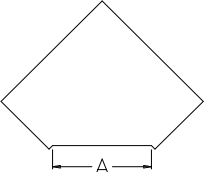
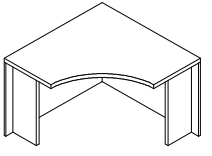
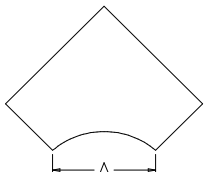
Description	Model Number	Overall Dimensions (in.)			Notes	Price (US\$)	Weight (lbs.)
		Depth	Width	Height			
Corner Bridge	_BC0-3636	36	36	29¼	connects to 20" units each side "A" = 19"	1913	185
 	_BC0-4242	42	42	29¼	connects to 20" or 24" units* 20" units each side "A" = 27⅞" 24" unit on one side and 20" or 24" unit on other side "A" = 21¾"	2202	225
	<p>Seated Diagonal Full finished modesty panels</p>						
Corner Bridge	_BC000D-3636	36	36	29¼	connects to 20" units each side "A" = 22⅝"	1913	185
 	_BC000D-4242	42	42	29¼	connects to 20" or 24" units* 20" units each side "A" = 31⅛ " 24" units one side and 20" or 24" unit on other side "A" = 25½"	2202	225
	<p>* Depth of connecting units will determine actual top size. Corner bridge may be longer and adjacent unit shorter to maintain a 45 front edge. The adjustment will be made at the factory and will not affect the overall configured size.</p>						
<p>Seated Radius Full finished modesty panels</p>							

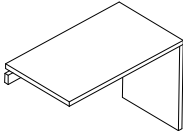
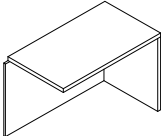
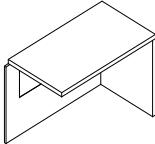
Description	Model Number	Overall Dimensions (in.)			Notes	Price (US\$)	Weight (lbs.)	
		Depth	Width	Height				
	Return	_R000K-2030-R	20	30	29¼	981	52	
		_R000K-2036-R	20	36	29¼	1033	56	
		_R000K-2042-R	20	42	29¼	1090	60	
		_R000K-2048-R	20	48	29¼	1142	64	
		_R000K-2054-R	20	54	29¼	1199	69	
		_R000K-2060-R	20	60	29¼	1253	73	
		_R000K-2430-R	24	30	29¼	1035	60	
		_R000K-2436-R	24	36	29¼	1092	65	
		_R000K-2442-R	24	42	29¼	1150	70	
		_R000K-2448-R	24	48	29¼	1208	75	
	Open back with solid wood keel	_R000K-2454-R	24	54	29¼	1267	80	
	Specify L or R (Right indicated)	_R000K-2460-R	24	60	29¼	1325	85	
		Return	_R000L-2030-R	20	30	29¼	1251	69
			_R000L-2036-R	20	36	29¼	1331	77
		_R000L-2042-R	20	42	29¼	1413	85	
		_R000L-2048-R	20	48	29¼	1496	92	
		_R000L-2054-R	20	54	29¼	1577	100	
		_R000L-2060-R	20	60	29¼	1658	108	
		_R000L-2430-R	24	30	29¼	1315	78	
		_R000L-2436-R	24	36	29¼	1402	86	
		_R000L-2442-R	24	42	29¼	1483	95	
		_R000L-2448-R	24	48	29¼	1570	103	
Full finished modesty panel		_R000L-2454-R	24	54	29¼	1656	112	
Specify L or R (Right indicated)		_R000L-2460-R	24	60	29¼	1740	120	
		Return	_R000H-2030-R	20	30	29¼	1267	70
			_R000H-2036-R	20	36	29¼	1351	78
		_R000H-2042-R	20	42	29¼	1430	86	
		_R000H-2048-R	20	48	29¼	1513	93	
		_R000H-2054-R	20	54	29¼	1597	101	
		_R000H-2060-R	20	60	29¼	1677	109	
		_R000H-2430-R	24	30	29¼	1331	78	
		_R000H-2436-R	24	36	29¼	1419	87	
		_R000H-2442-R	24	42	29¼	1503	95	
		_R000H-2448-R	24	48	29¼	1590	104	
	Full finished modesty panel	_R000H-2454-R	24	54	29¼	1675	113	
	Specify L or R (Right Indicated)	_R000H-2460-R	24	60	29¼	1759	121	

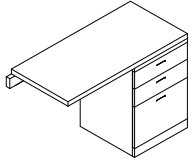
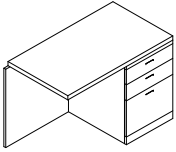
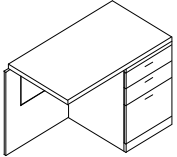
Description	Model Number	Overall Dimensions (in.)			Notes	Price (US\$)	Weight (lbs.)
		Depth	Width	Height			
	Return	_R000K-2030-CR	20	30	29¼	1626	101
		_R000K-2036-CR	20	36	29¼	1682	105
		_R000K-2042-CR	20	42	29¼	1738	109
		_R000K-2048-CR	20	48	29¼	1790	113
		_R000K-2054-CR	20	54	29¼	1847	118
		_R000K-2060-CR	20	60	29¼	1902	122
		_R000K-2430-CR	24	30	29¼	1719	105
		_R000K-2436-CR	24	36	29¼	1777	110
		_R000K-2442-CR	24	42	29¼	1833	115
	Open back with keel	_R000K-2448-CR	24	48	29¼	1892	120
Legal width b/b/f pedestal	_R000K-2454-CR	24	54	29¼	1948	125	
Specify L or R (Right indicated)	_R000K-2460-CR	24	60	29¼	2010	130	
	Return	_R000L-2030-CR	20	30	29¼	1896	118
		_R000L-2036-CR	20	36	29¼	1979	126
		_R000L-2042-CR	20	42	29¼	2059	134
		_R000L-2048-CR	20	48	29¼	2142	141
		_R000L-2054-CR	20	54	29¼	2226	149
		_R000L-2060-CR	20	60	29¼	2306	157
		_R000L-2430-CR	24	30	29¼	1999	123
		_R000L-2436-CR	24	36	29¼	2083	131
		_R000L-2442-CR	24	42	29¼	2167	140
	Full finished modesty panel	_R000L-2448-CR	24	48	29¼	2253	148
Legal width b/b/f pedestal	_R000L-2454-CR	24	54	29¼	2336	157	
Specify L or R (Right indicated)	_R000L-2460-CR	24	60	29¼	2423	165	
	Return	_R000H-2030-CR	20	30	29¼	2033	110
		_R000H-2036-CR	20	36	29¼	1868	118
		_R000H-2042-CR	20	42	29¼	1951	125
		_R000H-2048-CR	20	48	29¼	2116	133
		_R000H-2054-CR	20	54	29¼	2281	141
		_R000H-2060-CR	20	60	29¼	2200	149
		_R000H-2430-CR	24	30	29¼	1971	114
		_R000H-2436-CR	24	36	29¼	2057	123
		_R000H-2442-CR	24	42	29¼	2141	131
	Hinged modesty panel	_R000H-2448-CR	24	48	29¼	2228	140
Legal width b/b/f pedestal	_R000H-2454-CR	24	54	29¼	2311	149	
Specify L or R (Right indicated)	_R000H-2460-CR	24	60	29¼	2398	157	

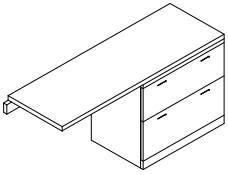
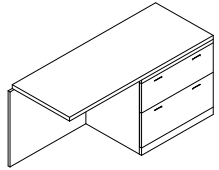
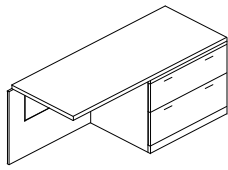
Description	Model Number	Overall Dimensions (in.)			Notes	Price (US\$)	Weight (lbs.)
		Depth	Width	Height			
 Return Open back with solid wood keel 30" w lateral file pedestal Specify L or R	_R000K-2048-ER	20	48	29¼		2054	133
	_R000K-2054-ER	20	54	29¼		2111	138
	_R000K-2060-ER	20	60	29¼		2164	142
	_R000K-2066-ER	20	66	29¼		2221	146
	_R000K-2072-ER	20	72	29¼		2285	150
	_R000K-2448-ER	24	48	29¼		2155	140
	_R000K-2454-ER	24	54	29¼		2211	145
	_R000K-2460-ER	24	60	29¼		2269	150
	_R000K-2466-ER	24	66	29¼		2326	155
	_R000K-2472-ER (R ight indicated)	24	72	29¼		2395	160
 Return Full finished modesty panel 30" w lateral file pedestal Specify L or R	_R000L-2048-ER	20	48	29¼		2408	161
	_R000L-2054-ER	20	54	29¼		2489	169
	_R000L-2060-ER	20	60	29¼		2569	177
	_R000L-2066-ER	20	66	29¼		2654	184
	_R000L-2072-ER	20	72	29¼		2744	192
	_R000L-2448-ER	24	48	29¼		2514	168
	_R000L-2454-ER	24	54	29¼		2600	177
	_R000L-2460-ER	24	60	29¼		2686	185
	_R000L-2466-ER	24	66	29¼		2768	194
	_R000L-2472-ER (R ight indicated)	24	72	29¼		2862	202
 Return Full finished modesty panel 30" w lateral file pedestal Specify L or R	_R000H-2048-ER	20	48	29¼		2334	144
	_R000H-2054-ER	20	54	29¼		2418	152
	_R000H-2060-ER	20	60	29¼		2498	160
	_R000H-2066-ER	20	66	29¼		2586	168
	_R000H-2072-ER	20	72	29¼		2675	175
	_R000H-2448-ER	24	48	29¼		2442	151
	_R000H-2454-ER	24	54	29¼		2528	160
	_R000H-2460-ER	24	60	29¼		2616	168
	_R000H-2466-ER	24	66	29¼		2700	177
	_R000H-2472-ER (R ight indicated)	24	72	29¼		2795	185

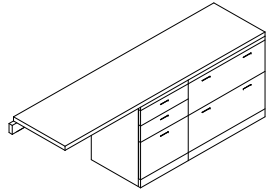
Description	Model Number	Overall Dimensions (in.)			Notes	Price (US\$)	Weight (lbs.)
		Depth	Width	Height			
	Return	_R000K-2078-CER	20	78	29¼	3378	234
		_R000K-2084-CER	20	84	29¼	3444	238
		_R000K-2090-CER	20	90	29¼	3499	243
		_R000K-2096-CER	20	96	29¼	3554	247
		_R000K-2478-CER	24	78	29¼	3560	245
		_R000K-2484-CER	24	84	29¼	3615	250
		_R000K-2490-CER	24	90	29¼	3676	255
		_R000K-2496-CER	24	96	29¼	3733	260

Open back with keel

30" w lateral file & legal width b/b/f pedestal

Specify **Left** or **Right** (seated) (Right indicated)

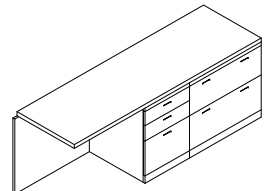
	Return	_R000L-2078-CER	20	78	29¼	3877	280
		_R000L-2084-CER	20	84	29¼	3956	287
		_R000L-2090-CER	20	90	29¼	4039	295
		_R000L-2096-CER	20	96	29¼	4123	303
		_R000L-2478-CER	24	78	29¼	4055	291
		_R000L-2484-CER	24	84	29¼	4139	299
		_R000L-2490-CER	24	90	29¼	4226	308
		_R000L-2496-CER	24	96	29¼	4312	316

Full finished modesty panel

30" w lateral file & legal width b/b/f pedestal

Specify **Left** or **Right** (seated) (Right indicated)

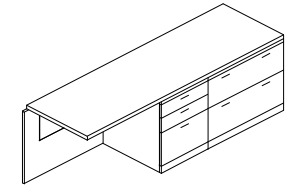
	Return	_R000H-2078-CER	20	78	29¼	3760	254
		_R000H-2084-CER	20	84	29¼	3843	262
		_R000H-2090-CER	20	90	29¼	3928	270
		_R000H-2096-CER	20	96	29¼	4012	277
		_R000H-2478-CER	24	78	29¼	3942	265
		_R000H-2484-CER	24	84	29¼	4026	274
		_R000H-2490-CER	24	90	29¼	4113	282
		_R000H-2496-CER	24	96	29¼	4199	291

Hinged modesty panel

30" w lateral file & legal width b/b/f pedestal

Specify **Left** or **Right** (seated) (Right indicated)

FOUNDATION

Above pricing reflects standard cherry and maple finishes.

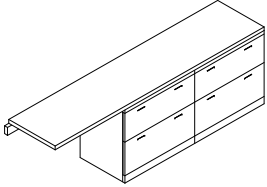
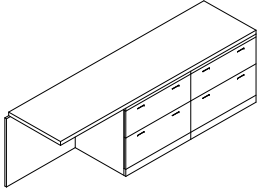
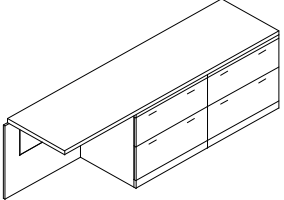
Description	Model Number	Overall Dimensions (in.)			Notes	Price (US\$)	Weight (lbs.)
		Depth	Width	Height			
 <p>Open back with keel 2-30" w lateral file pedestal Specify Left or Right (seated)</p>	_R000K-2090-EER	20	90	29¼		3761	263
	_R000K-2096-EER	20	96	29¼		3817	267
	_R000K-2490-EER	24	90	29¼		3939	275
	_R000K-2496-EER	24	96	29¼		3995	280
	<hr/>						
	 <p>Full finished modesty panel 2- 30" w lateral file pedestals Specify Left or Right (seated)</p>	_R000L-2090-EER	20	90	29¼		4304
_R000L-2096-EER		20	96	29¼		4385	323
_R000L-2490-EER		24	90	29¼		4489	328
_R000L-2496-EER		24	96	29¼		4574	336
<hr/>							
 <p>Hinged modesty panel 2- 30" w lateral file pedestals Specify Left or Right (seated)</p>		_R000H-2090-EER	20	90	29¼		4145
	_R000H-2096-EER	20	96	29¼		4229	288
	_R000H-2490-EER	24	90	29¼		4329	293
	_R000H-2496-EER	24	96	29¼		4415	302

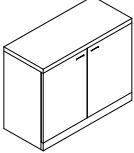
Description	Model Number	Overall Dimensions (in.)			Notes	Price (US\$)	Weight (lbs.)
		Depth	Width	Height			
 Full Storage Credenza	_C000K-2030-HH	20	30	29¼	1 adjustable shelf	1601	81
	_C000K-2036-HH	20	36	29¼	1 adjustable shelf	1654	85
	_C000K-2042-HH	20	42	29¼	1 adjustable shelf	1710	89
	_C000K-2430-HH	24	30	29¼	1 adjustable shelf	1687	85
	_C000K-2436-HH	24	36	29¼	1 adjustable shelf	1745	90
	_C000K-2442-HH	24	42	29¼	1 adjustable shelf	1802	95

Unfinished back

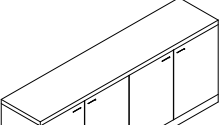
 Full Storage Credenza	_C000K-2060-HHHH	20	60	29¼	2 bay, 1 adjustable shelf each bay	2608	162
	_C000K-2072-HHHH	20	72	29¼	2 bay, 1 adjustable shelf each bay	2729	170
	_C000K-2460-HHHH	24	60	29¼	2 bay, 1 adjustable shelf each bay	2766	170
	_C000K-2472-HHHH	24	72	29¼	2 bay, 1 adjustable shelf each bay	2892	180

Unfinished back

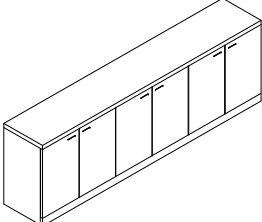
 Full Storage Credenza	_C000K-2084-HHHHHH	20	84	29¼	3 bay, 1 adjustable shelf each bay	3573	198
	_C000K-2090-HHHHHH	20	90	29¼	3 bay, 1 adjustable shelf each bay	3631	203
	_C000K-2096-HHHHHH	20	96	29¼	3 bay, 1 adjustable shelf each bay	3683	207
	_C000K-2484-HHHHHH	24	84	29¼	3 bay, 1 adjustable shelf each bay	3797	210
	_C000K-2490-HHHHHH	24	90	29¼	3 bay, 1 adjustable shelf each bay	3856	215
	_C000K-2496-HHHHHH	24	96	29¼	3 bay, 1 adjustable shelf each bay	3911	220

Unfinished back

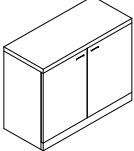
Description	Model Number	Overall Dimensions (in.)			Notes	Price (US\$)	Weight (lbs.)
		Depth	Width	Height			
	_C000L-2030-HH	20	30	29¼	1 adjustable shelf	1868	98
	_C000L-2036-HH	20	36	29¼	1 adjustable shelf	1952	106
	_C000L-2042-HH	20	42	29¼	1 adjustable shelf	2034	114
	_C000L-2430-HH	24	30	29¼	1 adjustable shelf	1968	103
	_C000L-2436-HH	24	36	29¼	1 adjustable shelf	2054	111
	_C000L-2442-HH	24	42	29¼	1 adjustable shelf	2136	120

Full finished modesty panel

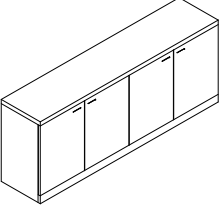
	_C000L-2060-HHHH	20	60	29¼	2 bay, 1 adjustable shelf each bay	3012	197
	_C000L-2072-HHHH	20	72	29¼	2 bay, 1 adjustable shelf each bay	3188	212
	_C000L-2460-HHHH	24	60	29¼	2 bay, 1 adjustable shelf each bay	3183	205
	_C000L-2472-HHHH	24	72	29¼	2 bay, 1 adjustable shelf each bay	3360	222

Full finished modesty panel

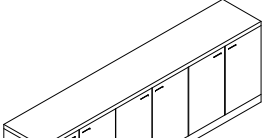
	_C000L-2084-HHHHHH	20	84	29¼	3 bay, 1 adjustable shelf each bay	4088	247
	_C000L-2090-HHHHHH	20	90	29¼	3 bay, 1 adjustable shelf each bay	4172	255
	_C000L-2096-HHHHHH	20	96	29¼	3 bay, 1 adjustable shelf each bay	4256	263
	_C000L-2484-HHHHHH	24	84	29¼	3 bay, 1 adjustable shelf each bay	4318	259
	_C000L-2490-HHHHHH	24	90	29¼	3 bay, 1 adjustable shelf each bay	4405	268
	_C000L-2496-HHHHHH	24	96	29¼	3 bay, 1 adjustable shelf each bay	4491	276

Full finished modesty panel

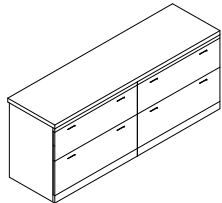
Description	Model Number	Overall Dimensions (in.)			Notes	Price (US\$)	Weight (lbs.)
		Depth	Width	Height			
Freestanding Storage Credenza	_C000N-2060-EE	20	60 ¹ / ₈	29 ¹ / ₄	2-30"w lateral file pedestal	3403	242
	_C000N-2072-FF	20	72 ¹ / ₈	29 ¹ / ₄	2-36"w lateral file pedestal	3512	250
	_C000N-2460-EE	24	60 ¹ / ₈	29 ¹ / ₄	2-30"w lateral file pedestal	3561	250
	_C000N-2472-FF	24	72 ¹ / ₈	29 ¹ / ₄	2-36"w lateral file pedestal	3675	260

Unfinished back

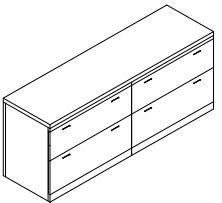
Freestanding Storage Credenza	_C000L-2060 EE	20	60 ¹ / ₈	29 ¹ / ₄	2-30"w lateral file pedestal	3852	277
	_C000L-2072-FF	20	72 ¹ / ₈	29 ¹ / ₄	2-36"w lateral file pedestal	4028	292
	_C000L-2460-EE	24	60 ¹ / ₈	29 ¹ / ₄	2-30"w lateral file pedestal	4023	285
	_C000L-2472-FF	24	72 ¹ / ₈	29 ¹ / ₄	2-36"w lateral file pedestal	4202	302

Full finished modesty panel

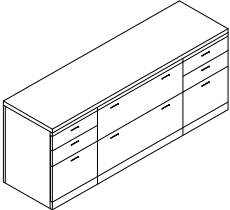
Description	Model Number	Overall Dimensions (in.)			Notes	Price (US\$)	Weight (lbs.)
		Depth	Width	Height			
	_C000N-2068-CEC	20	68½	29¼	2- legal width b/b/f pedestals 30" w lateral file pedestal	4256	307
	_C000N-2074-CFC	20	73½	29¼	2- legal width b/b/f pedestals 36" w lateral file pedestal	4314	311
	_C000N-2468-CEC	24	68½	29¼	2- legal width b/b/f pedestals 30" w lateral file pedestal	4472	317
	_C000N-2474-CFC	24	73½	29¼	2- legal width b/b/f pedestals 36" w lateral file pedestal	4535	322

Unfinished back

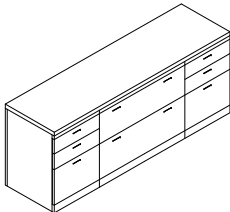
	_C000L-2068-CEC	20	68½	29¼	2- legal width b/b/f pedestals 30" w lateral file pedestal	4749	347
	_C000L-2074-CFC	20	73½	29¼	2- legal width b/b/f pedestals 36" w lateral file pedestal	4839	355
	_C000L-2468-CEC	24	68½	29¼	2- legal width b/b/f pedestals 30" w lateral file pedestal	4976	356
	_C000L-2474-CFC	24	73½	29¼	2- legal width b/b/f pedestals 36" w lateral file pedestal	5070	365

Full finished modesty panel

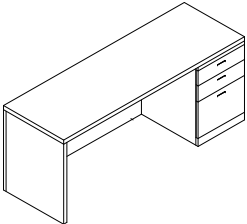
Description	Model Number	Overall Dimensions (in.)			Notes	Price (US\$)	Weight (lbs.)
		Depth	Width	Height			
	_C000L-2060-CR	20	60	29¼		2679	188
	_C000L-2066-CR	20	66	29¼		2764	195
	_C000L-2072-CR	20	72	29¼		2854	203
	_C000L-2078-CR	20	78	29¼		2937	211
	_C000L-2084-CR	20	84	29¼		3019	218
	_C000L-2090-CR	20	90	29¼		3102	226
	_C000L-2096-CR	20	96	29¼		3186	234
	_C000L-2460-CR	24	60	29¼		2813	200
	_C000L-2466-CR	24	66	29¼		2897	209
	_C000L-2472-CR	24	72	29¼		2993	217
	_C000L-2478-CR	24	78	29¼		3080	226
	_C000L-2484-CR	24	84	29¼		3164	234
	_C000L-2490-CR	24	90	29¼		3251	243
	_C000L-2496-CR	24	96	29¼		3336	251

Full finished modesty panel
 Legal width b/b/f pedestal
 Specify **Left** or **Right** (seated)

(**Right** indicated)

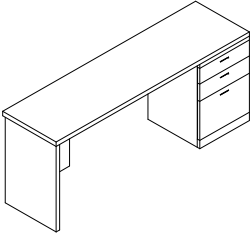
	_C000K-2060-CR	20	60	29¼		2277	153
	_C000K-2066-CR	20	66	29¼		2331	157
	_C000K-2072-CR	20	72	29¼		2395	161
	_C000K-2078-CR	20	78	29¼		2450	165
	_C000K-2084-CR	20	84	29¼		2503	169
	_C000K-2090-CR	20	90	29¼		2562	174
	_C000K-2096-CR	20	96	29¼		2615	178
	_C000K-2460-CR	24	60	29¼		2396	165
	_C000K-2466-CR	24	66	29¼		2456	170
	_C000K-2472-CR	24	72	29¼		2522	175
	_C000K-2478-CR	24	78	29¼		2583	180
	_C000K-2484-CR	24	84	29¼		2640	185
	_C000K-2490-CR	24	90	29¼		2699	190
	_C000K-2496-CR	24	96	29¼		2757	195

Open back with keel
 Legal width b/b/f pedestal
 Specify **Left** or **Right** (seated)

(**Right** indicated)

note: unfinished black pedestal back

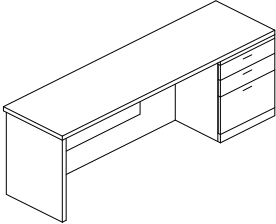
Description	Model Number	Overall Dimensions (in.)			Notes	Price (US\$)	Weight (lbs.)
		Depth	Width	Height			
Credenza 	_C000H-2060-CR	20	60	29¼		2653	180
	_C000H-2066-CR	20	66	29¼		2738	188
	_C000H-2072-CR	20	72	29¼		2831	196
	_C000H-2078-CR	20	78	29¼		2914	203
	_C000H-2084-CR	20	84	29¼		2996	211
	_C000H-2090-CR	20	90	29¼		3079	219
	_C000H-2096-CR	20	96	29¼		3166	227
	_C000H-2460-CR	24	60	29¼		2788	192
	_C000H-2466-CR	24	66	29¼		2872	201
	_C000H-2472-CR	24	72	29¼		2967	209
	_C000H-2478-CR	24	78	29¼		3057	218
	_C000H-2484-CR	24	84	29¼		3141	227
	_C000H-2490-CR	24	90	29¼		3228	235
	_C000H-2496-CR	24	96	29¼		3314	244
	Hinged modesty panel Legal width b/b/f pedestal Specify Left or Right (seated)	(Right indicated)				note: unfinished black pedestal back	

note: unfinished black back

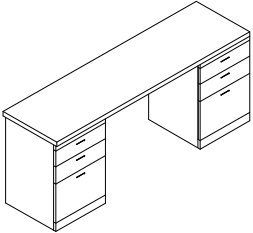
Description	Model Number	Overall Dimensions (in.)			Notes	Price (US\$)	Weight (lbs.)
		Depth	Width	Height			
	_C000K-2066-CKC	20	66	29¼		2978	206
	_C000K-2072-CKC	20	72	29¼		3041	210
	_C000K-2078-CKC	20	78	29¼		3100	214
	_C000K-2084-CKC	20	84	29¼		3153	218
	_C000K-2090-CKC	20	90	29¼		3209	223
	_C000K-2096-CKC	20	96	29¼		3263	227
	_C000K-2466-CKC	24	66	29¼		3136	215
	_C000K-2472-CKC	24	72	29¼		3207	220
	_C000K-2478-CKC	24	78	29¼		3264	225
	_C000K-2484-CKC	24	84	29¼		3324	230
	_C000K-2490-CKC	24	90	29¼		3382	235
	_C000K-2496-CKC	24	96	29¼		3441	240

Open back with keel
2 legal width b/b/f pedestals

(note: unfinished black pedestal back)

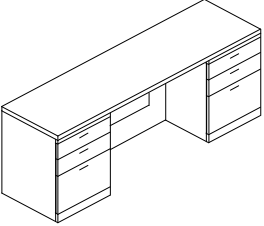
	_C000H-2066-CKC	20	66	29¼		3342	228
	_C000H-2072-CKC	20	72	29¼		3435	235
	_C000H-2078-CKC	20	78	29¼		3518	243
	_C000H-2084-CKC	20	84	29¼		3600	251
	_C000H-2090-CKC	20	90	29¼		3683	259
	_C000H-2096-CKC	20	96	29¼		3767	267
	_C000H-2466-CKC	24	66	29¼		3510	237
	_C000H-2472-CKC	24	72	29¼		3606	245
	_C000H-2478-CKC	24	78	29¼		3693	254
	_C000H-2484-CKC	24	84	29¼		3780	263
	_C000H-2490-CKC	24	90	29¼		3866	271
	_C000H-2496-CKC	24	96	29¼		3952	280

Hinged modesty panel
2 legal width b/b/f pedestals

(note: unfinished black back)

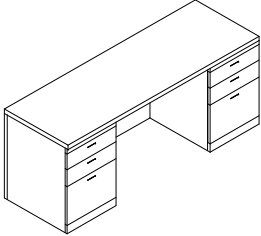
Description	Model Number	Overall Dimensions (in.)			Notes	Price (US\$)	Weight (lbs.)
		Depth	Width	Height			
	_C000L-2066-CKC	20	66	29¼		3410	244
	_C000L-2072-CKC	20	72	29¼		3503	252
	_C000L-2078-CKC	20	78	29¼		3586	260
	_C000L-2084-CKC	20	84	29¼		3668	267
	_C000L-2090-CKC	20	90	29¼		3752	275
	_C000L-2096-CKC	20	96	29¼		3836	283
	_C000L-2466-CKC	24	66	29¼		3582	254
	_C000L-2472-CKC	24	72	29¼		3677	262
	_C000L-2478-CKC	24	78	29¼		3763	271
	_C000L-2484-CKC	24	84	29¼		3847	279
	_C000L-2490-CKC	24	90	29¼		3934	288
	_C000L-2496-CKC	24	96	29¼		4017	296

Full finished modesty panel
2 legal width b/b/f pedestals

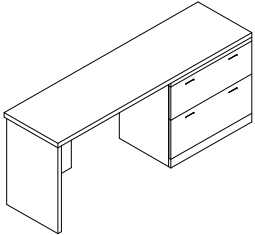
	_C000K-2060-ER	20	60	29¼		2540	173
	_C000K-2066-ER	20	66	29¼		2594	177
	_C000K-2072-ER	20	72	29¼		2658	181
	_C000K-2078-ER	20	78	29¼		2716	185
	_C000K-2084-ER	20	84	29¼		2770	189
	_C000K-2090-ER	20	90	29¼		2825	194
	_C000K-2096-ER	20	96	29¼		2880	198
	_C000K-2460-ER	24	60	29¼		2660	185
	_C000K-2466-ER	24	66	29¼		2715	190
	_C000K-2472-ER	24	72	29¼		2786	195
	_C000K-2478-ER	24	78	29¼		2843	200
	_C000K-2484-ER	24	84	29¼		2900	205
	_C000K-2490-ER	24	90	29¼		2961	210
	_C000K-2496-ER	24	96	29¼		3017	215

Open back with keel
30" w lateral file pedestal
Specify **Left** or **Right** (seated)

(**R**ight indicated)

(note: unfinished black pedestal back)

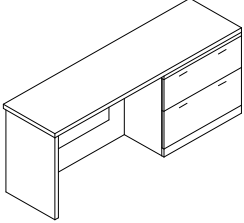
Description	Model Number	Overall Dimensions (in.)			Notes	Price (US\$)	Weight (lbs.)
		Depth	Width	Height			
Credenza 	_C000H-2066-ER	20	66	29¼		2959	199
	_C000H-2072-ER	20	72	29¼		3048	206
	_C000H-2078-ER	20	78	29¼		3132	214
	_C000H-2084-ER	20	84	29¼		3216	222
	_C000H-2090-ER	20	90	29¼		3300	230
	_C000H-2096-ER	20	96	29¼		3384	238
	_C000H-2466-ER	24	66	29¼		3087	212
	_C000H-2472-ER	24	72	29¼		3185	220
	_C000H-2478-ER	24	78	29¼		3272	229
	_C000H-2484-ER	24	84	29¼		3356	238
	_C000H-2490-ER	24	90	29¼		3442	246
	_C000H-2496-ER	24	96	29¼		3528	255

Hinged modesty panel

30" w lateral file pedestal

Specify **Left** or **Right** (seated)

(**Right** indicated)

(note: unfinished black back)

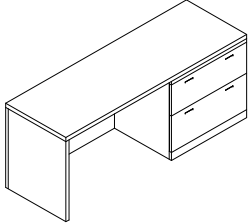
Credenza 	_C000L-2066-ER	20	66	29¼		3027	215
	_C000L-2072-ER	20	72	29¼		3120	223
	_C000L-2078-ER	20	78	29¼		3203	231
	_C000L-2084-ER	20	84	29¼		3284	238
	_C000L-2090-ER	20	90	29¼		3367	246
	_C000L-2096-ER	20	96	29¼		3449	254
	_C000L-2466-ER	24	66	29¼		3157	229
	_C000L-2472-ER	24	72	29¼		3253	237
	_C000L-2478-ER	24	78	29¼		3340	246
	_C000L-2484-ER	24	84	29¼		3424	254
	_C000L-2490-ER	24	90	29¼		3510	263
	_C000L-2496-ER	24	96	29¼		3596	271

Full finished modesty panel

30" w lateral file pedestal

Specify **Left** or **Right** (seated)

(**Right** indicated)

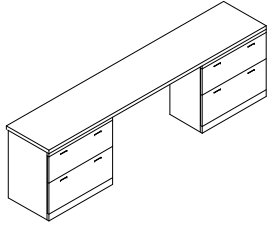
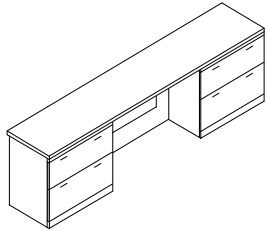
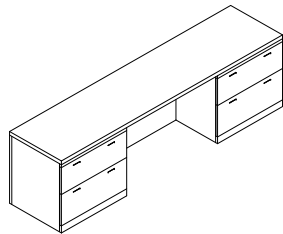
Description	Model Number	Overall Dimensions (in.)			Notes	Price (US\$)	Weight (lbs.)
		Depth	Width	Height			
Credenza 	_C000K-2090-EKE	20	90	29¼		3736	263
	_C000K-2096-EKE	20	96	29¼		3788	267
	_C000K-2490-EKE	24	90	29¼		3907	275
	_C000K-2496-EKE	24	96	29¼		3967	280
Open back with keel 2- 30"w lateral file pedestals					(note: unfinished black back)		
Credenza 	_C000H-2090-EKE	20	90	29¼		4117	281
	_C000H-2096-EKE	20	96	29¼		4201	288
	_C000H-2490-EKE	24	90	29¼		4301	293
	_C000H-2496-EKE	24	96	29¼		4387	302
Hinged modesty panel 2- 30"w lateral file pedestals					(note: unfinished black pedestal back)		
Credenza 	_C000L-2090-EKE	20	90	29¼		4276	315
	_C000L-2096-EKE	20	96	29¼		4360	323
	_C000L-2490-EKE	24	90	29¼		4457	328
	_C000L-2496-EKE	24	96	29¼		4543	336
Full finished modesty panel 2- 30"w lateral file pedestals							

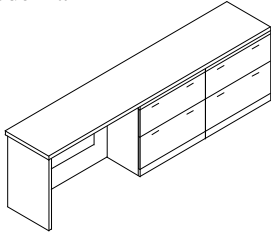
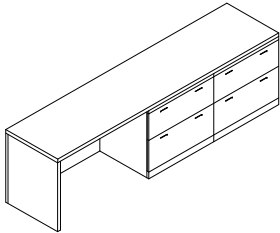
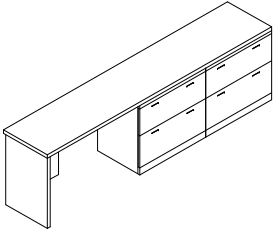
Description	Model Number	Overall Dimensions (in.)			Notes	Price (US\$)	Weight (lbs.)
		Depth	Width	Height			
Credenza 	_C000H-2090-EER	20	90	29¼		4518	312
	_C000H-2096-EER	20	96	29¼		4602	320
	_C000H-2490-EER	24	90	29¼		4720	328
	_C000H-2496-EER	24	96	29¼		4806	337
Hinged modesty panel 2- 30"w lateral file pedestals Specify Left or Right (seated)		(Right indicated)			(note: unfinished black back)		
Credenza 	_C000L-2090-EER	20	90	29¼		4677	346
	_C000L-2096-EER	20	96	29¼		4761	354
	_C000L-2490-EER	24	90	29¼		4878	363
	_C000L-2496-EER	24	96	29¼		4964	371
Full finished modesty panel 2- 30"w lateral file pedestals Specify Left or Right (seated)		(Right indicated)					
Credenza 	_C000K-2090-EER	20	90	29¼		4137	294
	_C000K-2096-EER	20	96	29¼		4190	298
	_C000K-2490-EER	24	90	29¼		4326	310
	_C000K-2496-EER	24	96	29¼		4385	315
Open back with keel 2- 30"w lateral file pedestals Specify Left or Right (seated)		(Right indicated)			(note: unfinished black pedestal back)		

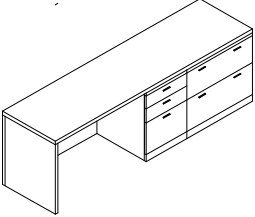
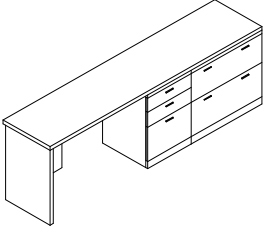
Description	Model Number	Overall Dimensions (in.)			Notes	Price (US\$)	Weight (lbs.)	
		Depth	Width	Height				
	_C000L-2078-CER	20	78	29¼		4249	311	
	_C000L-2084-CER	20	84	29¼		4331	318	
	_C000L-2090-CER	20	90	29¼		4415	326	
	_C000L-2096-CER	20	96	29¼		4499	334	
	_C000L-2478-CER	24	78	29¼		4446	326	
	_C000L-2484-CER	24	84	29¼		4530	334	
	_C000L-2490-CER	24	90	29¼		4616	343	
	_C000L-2496-CER	24	96	29¼		4702	351	
	<p>Full finished modesty panel Legal width b/b/f pedestal and 30" w lateral file pedestal Specify Left or Right (seated) (Right indicated)</p>							
		_C000K-2078-CER	20	78	29¼		3763	265
_C000K-2084-CER		20	84	29¼		3817	269	
_C000K-2090-CER		20	90	29¼		3875	274	
_C000K-2096-CER		20	96	29¼		3927	278	
_C000K-2478-CER		24	78	29¼		3949	280	
_C000K-2484-CER		24	84	29¼		4006	285	
_C000K-2490-CER		24	90	29¼		4064	290	
_C000K-2496-CER		24	96	29¼		4122	295	
<p>Open back with keel Legal width b/b/f pedestal and 30" w lateral file pedestal Specify Left or Right (seated) (Right indicated) (note: unfinished black pedestal back)</p>								

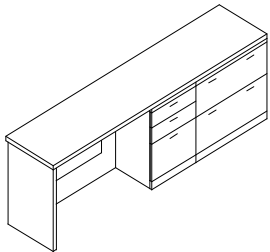
Description	Model Number	Overall Dimensions (in.)			Notes	Price (US\$)	Weight (lbs.)
		Depth	Width	Height			
<p>Credenza</p> 	_C000H-2078-CER	20	78	29¼		4136	285
	_C000H-2084-CER	20	84	29¼		4218	293
	_C000H-2090-CER	20	90	29¼		4302	301
	_C000H-2096-CER	20	96	29¼		4386	309
	_C000H-2478-CER	24	78	29¼		4332	300
	_C000H-2484-CER	24	84	29¼		4416	309
	_C000H-2490-CER	24	90	29¼		4502	317
	_C000H-2496-CER	24	96	29¼		4586	326
<p>Hinged modesty panel Legal width b/b/f pedestal and 30" w lateral file pedestal Specify Left or Right (seated)</p>	(R ight indicated)				(note: unfinished black back)		

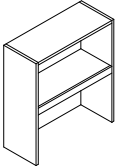
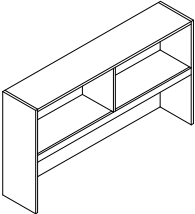
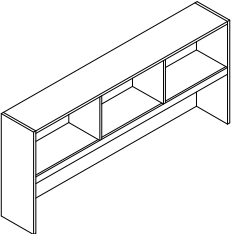
Description	Model Number	Overall Dimensions (in.)			Notes	Price (US\$)	Weight (lbs.)	
		Depth	Width	Height				
 <p>1 bay</p>	Open Storage Hi-Rise	xSUN10-1436	14¼	36	41¼	1386	76	
		xSUN10-1442	14¼	42	41¼	1434	84	
		xSUN11-1436	14¼	36	53¼	1 adjustable shelf	1609	102
		xSUN11-1442	14¼	42	53¼	1 adjustable shelf	1674	114
	 <p>2 bay</p>	Open Storage Hi-Rise	xSUN20-1448	14¼	48	41¼	1739	98
			xSUN20-1454	14¼	54	41¼	1787	107
			xSUN20-1460	14¼	60	41¼	1835	115
			xSUN20-1466	14¼	66	41¼	1887	124
		xSUN20-1472	14¼	72	41¼	1946	132	
		xSUN20-1478	14¼	78	41¼	1994	141	
		xSUN21-1448	14¼	48	53¼	1 adjustable shelf each bay	2097	134
		xSUN21-1454	14¼	54	53¼	1 adjustable shelf each bay	2162	146
		xSUN21-1460	14¼	60	53¼	1 adjustable shelf each bay	2224	158
		xSUN21-1466	14¼	66	53¼	1 adjustable shelf each bay	2287	170
		xSUN21-1472	14¼	72	53¼	1 adjustable shelf each bay	2364	182
		xSUN21-1478	14¼	78	53¼	1 adjustable shelf each bay	2426	194
 <p>3 bay</p>	Open Storage Hi-Rise	xSUN30-1484	14¼	84	41¼	2298	155	
		xSUN30-1490	14¼	90	41¼	2350	163	
		xSUN30-1496	14¼	96	41¼	2398	172	
		xSUN31-1484	14¼	84	53¼	1 adjustable shelf each bay	2851	214
		xSUN31-1490	14¼	90	53¼	1 adjustable shelf each bay	2916	226
		xSUN31-1496	14¼	96	53¼	1 adjustable shelf each bay	2981	238

(note: all units on this page have unfinished backs)
(see page 60 for detailed top trim)

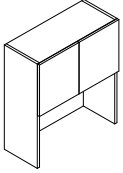
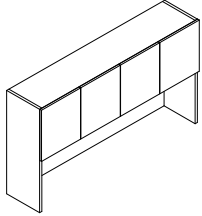
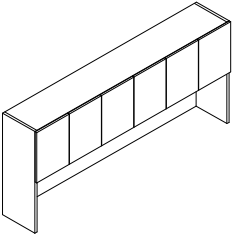
Description	Model Number	Overall Dimensions (in.)			Notes	Price (US\$)	Weight (lbs.)
		Depth	Width	Height			
 <p>Hinged Door Hi-Rise Storage</p>	xSUH10-1536	15	36	41¼		1742	93
	xSUH10-1542	15	42	41¼		1802	104
	xSUH11-1536	15	36	53¼	1 adjustable shelf	2016	130
	xSUH11-1542	15	42	53¼	1 adjustable shelf	2101	146
	1 bay, 2 hinged doors						
	<hr/>						
 <p>Hinged Door Hi-Rise Storage</p>	xSUH20-1548	15	48	41¼		2388	121
	xSUH20-1554	15	54	41¼		2451	132
	xSUH20-1560	15	60	41¼		2513	143
	xSUH20-1566	15	66	41¼		2576	155
	xSUH20-1572	15	72	41¼		2649	166
	xSUH20-1578	15	78	41¼		2711	177
	xSUH21-1548	15	48	53¼	1 adjustable shelf each bay	2816	171
	xSUH21-1554	15	54	53¼	1 adjustable shelf each bay	2901	187
	xSUH21-1560	15	60	53¼	1 adjustable shelf each bay	2986	203
	xSUH21-1566	15	66	53¼	1 adjustable shelf each bay	3071	220
	xSUH21-1572	15	72	53¼	1 adjustable shelf each bay	3168	236
	xSUH21-1578	15	78	53¼	1 adjustable shelf each bay	3253	252
	2 bay, 4 hinged doors						
	<hr/>						
 <p>Hinged Door Hi-Rise Storage</p>	xSUH30-1584	15	84	41¼		3298	194
	xSUH30-1590	15	90	41¼		3360	205
	xSUH30-1596	15	96	41¼		3426	216
	xSUH31-1584	15	84	53¼	1 adjustable shelf each bay	3969	277
	xSUH31-1590	15	90	53¼	1 adjustable shelf each bay	4057	293
	xSUH31-1596	15	96	53¼	1 adjustable shelf each bay	4142	309
3 bay, 6 hinged doors							
					(note: all units on this page have unfinished backs) (see page 60 for detailed top trim)		

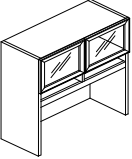
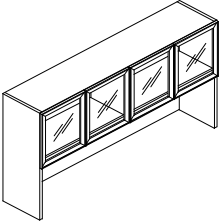
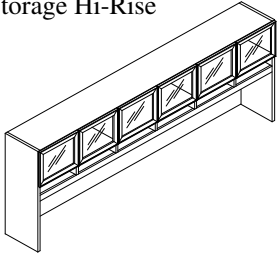
Description	Model Number	Overall Dimensions (in.)			Notes	Price (US\$)	Weight (lbs.)	
		Depth	Width	Height				
 <p>Open Storage Hi-Rise</p> <p>1 bay 2 metal framed frosted glass doors</p>	xSUH100A-1536	15	36	41¼		2605	107	
	xSUH100A-1542	15	42	41¼		2610	121	
	xSUH110A-1536	15	36	53¼	1 adjustable shelf	2946	153	
	xSUH110A-1542	15	42	53¼	1 adjustable shelf	3105	173	
	 <p>Open Storage Hi-Rise</p> <p>2 bay 4 metal framed frosted glass doors</p>	xSUH200A-1548	15	48	41¼		3742	140
		xSUH200A-1554	15	54	41¼		3847	154
		xSUH200A-1560	15	60	41¼		3955	167
		xSUH200A-1566	15	66	41¼		4060	181
xSUH200A-1572		15	72	41¼		4179	194	
xSUH200A-1578		15	78	41¼		4284	208	
xSUH210A-1548		15	48	53¼	1 adjustable shelf each bay	4392	202	
xSUH210A-1554		15	54	53¼	1 adjustable shelf each bay	4548	222	
xSUH210A-1560		15	60	53¼	1 adjustable shelf each bay	4707	242	
xSUH210A-1566		15	66	53¼	1 adjustable shelf each bay	4863	262	
xSUH210A-1572	15	72	53¼	1 adjustable shelf each bay	5033	282		
xSUH210A-1578	15	78	53¼	1 adjustable shelf each bay	5189	302		
 <p>Open Storage Hi-Rise</p> <p>3 bay 6 metal framed frosted glass doors</p>	xSUH300A-1584	15	84	41¼		5416	227	
	xSUH300A-1590	15	90	41¼		5524	241	
	xSUH300A-1596	15	96	41¼		5631	254	
	xSUH310A-1584	15	84	53¼	1 adjustable shelf each bay	6479	331	
	xSUH310A-1590	15	90	53¼	1 adjustable shelf each bay	6637	351	
	xSUH310A-1596	15	96	53¼	1 adjustable shelf each bay	6794	371	
	(note: all units on this page have unfinished backs) (see page 60 for detailed top trim)							

Description	Model Number	Overall Dimensions (in.)			Notes	Price (US\$)	Weight (lbs.)
		Depth	Width	Height			
Hinged Door Hi-Rise Storage	xSUH100F-1536	15	36	41¼		2061	93
	xSUH100F-1542	15	42	41¼		2126	104

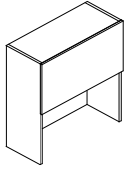

1 bay, 1 flipper door

Hinged Door Hi-Rise Storage	xSUH200F-1548	15	48	41¼		3009	121
	xSUH200F-1554	15	54	41¼		3077	132
	xSUH200F-1560	15	60	41¼		3143	143
	xSUH200F-1566	15	66	41¼		3210	155
	xSUH200F-1572	15	72	41¼		3287	166
	xSUH200F-1578	15	78	41¼		3355	177

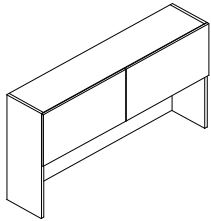

2 bay, 2 flipper doors

Hinged Door Hi-Rise Storage	xSUH300F-1584	15	84	41¼		4238	194
	xSUH300F-1590	15	90	41¼		4306	205
	xSUH300F-1596	15	96	41¼		4374	216

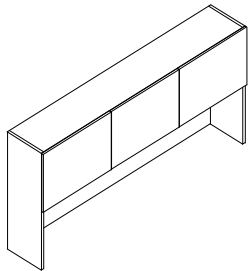

3 bay, 3 flipper doors

(note: all units on this page have unfinished backs)
(see page 60 for detailed top trim)

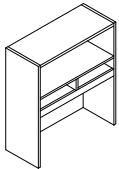
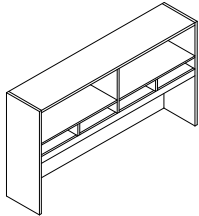
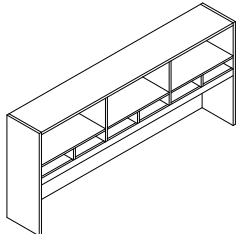
Description	Model Number	Overall Dimensions (in.)			Notes	Price (US\$)	Weight (lbs.)
		Depth	Width	Height			
Open Storage Hi-Rise with Organizer  1 bay	xSUO100-1436	14¼	36	41¼		1674	86
	xSUO100-1442	14¼	42	41¼		1734	97
	xSUO110-1436	14¼	36	53¼	1 adjustable shelf	1896	113
	xSUO110-1442	14¼	42	53¼	1 adjustable shelf	1970	126
	<hr/>						
	Open Storage Hi-Rise with Organizer  2 bay	xSUO200-1448	14¼	48	41¼		2150
xSUO200-1454		14¼	54	41¼		2209	122
xSUO200-1460		14¼	60	41¼		2269	133
xSUO200-1466		14¼	66	41¼		2329	143
xSUO200-1472		14¼	72	41¼		2406	153
xSUO200-1478		14¼	78	41¼		2464	164
xSUO210-1448		14¼	48	53¼	1 adjustable shelf each bay	2511	148
xSUO210-1454		14¼	54	53¼	1 adjustable shelf each bay	2584	162
xSUO210-1460		14¼	60	53¼	1 adjustable shelf each bay	2658	176
xSUO210-1466		14¼	66	53¼	1 adjustable shelf each bay	2732	189
xSUO210-1472		14¼	72	53¼	1 adjustable shelf each bay	2822	203
xSUO210-1478		14¼	78	53¼	1 adjustable shelf each bay	2896	217
<hr/>							
Open Storage Hi-Rise with Organizer  3 bay		xSUO300-1484	14¼	84	41¼		2884
	xSUO300-1490	14¼	90	41¼		2947	189
	xSUO300-1496	14¼	96	41¼		3006	200
	xSUO310-1484	14¼	84	53¼	1 adjustable shelf each bay	3437	239
	xSUO310-1490	14¼	90	53¼	1 adjustable shelf each bay	3513	252
	xSUO310-1496	14¼	96	53¼	1 adjustable shelf each bay	3587	266

(note: all units on this page have unfinished backs)
(see page 60 for detailed top trim)

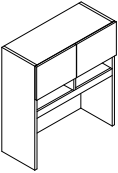
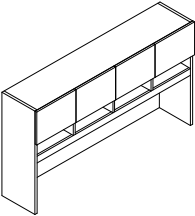
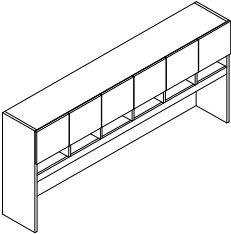
Description	Model Number	Overall Dimensions (in.)			Notes	Price (US\$)	Weight (lbs.)
		Depth	Width	Height			
Hinged Door Hi-Rise Storage with Organizer Below	xSUD10-1536	15	36	41¼		2032	104
	xSUD10-1542	15	42	41¼		2106	118
	xSUD11-1536	15	36	53¼	1 adjustable shelf	2306	141
	xSUD11-1542	15	42	53¼	1 adjustable shelf	2402	159
1 bay, 2 hinged doors							
Hinged Door Hi-Rise Storage with Organizer Below	xSUD20-1548	15	48	41¼		2808	136
	xSUD20-1554	15	54	41¼		2881	149
	xSUD20-1560	15	60	41¼		2953	162
	xSUD20-1566	15	66	41¼		3026	175
	xSUD20-1572	15	72	41¼		3116	188
	xSUD20-1578	15	78	41¼		3191	202
	xSUD21-1548	15	48	53¼	1 adjustable shelf each bay	3236	186
	xSUD21-1554	15	54	53¼	1 adjustable shelf each bay	3330	204
	xSUD21-1560	15	60	53¼	1 adjustable shelf each bay	3426	222
	xSUD21-1566	15	66	53¼	1 adjustable shelf each bay	3523	240
	xSUD21-1572	15	72	53¼	1 adjustable shelf each bay	3636	258
	xSUD21-1578	15	78	53¼	1 adjustable shelf each bay	3733	276
2 bay, 4 hinged doors							
Hinged Door Hi-Rise Storage with Organizer Below	xSUD30-1584	15	84	41¼		3896	220
	xSUD30-1590	15	90	41¼		3972	233
	xSUD30-1596	15	96	41¼		4046	246
	xSUD31-1584	15	84	53¼	1 adjustable shelf each bay	4566	303
	xSUD31-1590	15	90	53¼	1 adjustable shelf each bay	4665	321
	xSUD31-1596	15	96	53¼	1 adjustable shelf each bay	4762	339
3 bay, 6 hinged doors							

(note: all units on this page have unfinished
(note: see page 60 for detailed top trim))

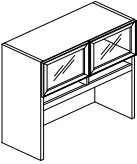
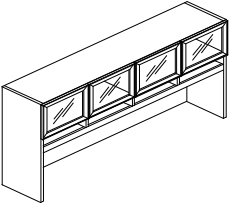
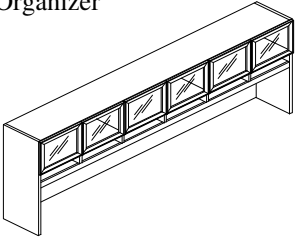
Description	Model Number	Overall Dimensions (in.)			Notes	Price (US\$)	Weight (lbs.)	
		Depth	Width	Height				
Open Storage Hi-Rise with Organizer	xSUD100A-1536	15	36	41¼		2796	119	
	xSUD100A-1542	15	42	41¼		2915	134	
	xSUD110A-1536	15	36	53¼	1 adjustable shelf	3239	164	
	xSUD110A-1542	15	42	53¼	1 adjustable shelf	3407	186	
1 bay 2 metal framed frosted glass doors								
Open Storage Hi-Rise with Organizer	xSUD200A-1548	15	48	41¼		4159	155	
	xSUD200A-1554	15	54	41¼		4279	170	
	xSUD200A-1560	15	60	41¼		4394	186	
	xSUD200A-1566	15	66	41¼		4511	201	
	xSUD200A-1572	15	72	41¼		4647	217	
	xSUD200A-1578	15	78	41¼		4766	232	
		xSUD210A-1548	15	48	53¼	1 adjustable shelf each bay	4812	217
xSUD210A-1554		15	54	53¼	1 adjustable shelf each bay	4979	239	
xSUD210A-1560		15	60	53¼	1 adjustable shelf each bay	5146	261	
xSUD210A-1566		15	66	53¼	1 adjustable shelf each bay	5313	283	
xSUD210A-1572		15	72	53¼	1 adjustable shelf each bay	5501	305	
xSUD210A-1578		15	78	53¼	1 adjustable shelf each bay	5671	327	
2 bay 4 metal framed frosted glass doors								
Open Storage Hi-Rise with Organizer	xSUD300A-1584	15	84	41¼		6013	253	
	xSUD300A-1590	15	90	41¼		6132	269	
	xSUD300A-1596	15	96	41¼		6252	284	
		xSUD310A-1584	15	84	53¼	1 adjustable shelf each bay	7076	358
		xSUD310A-1590	15	90	53¼	1 adjustable shelf each bay	7246	379
		xSUD310A-1596	15	96	53¼	1 adjustable shelf each bay	7413	401
		3 bay 6 metal framed frosted glass doors						
					(note: all units on this page have unfinished backs) (see page 60 for detailed top trim)			

Description	Model Number	Overall Dimensions (in.)			Notes	Price (US\$)	Weight (lbs.)
		Depth	Width	Height			
Hinged Door Hi-Rise Storage with Organizer Below	xSUD100F-1536	15	36	41¼		2351	104
	xSUD100F-1542	15	42	41¼		2428	118

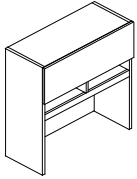

1 bay, 1 flipper door

Hinged Door Hi-Rise Storage with Organizer Below	xSUD200F-1548	15	48	41¼		3428	136
	xSUD200F-1554	15	54	41¼		3505	149
	xSUD200F-1560	15	60	41¼		3582	162
	xSUD200F-1566	15	66	41¼		3661	175
	xSUD200F-1572	15	72	41¼		3755	188
	xSUD200F-1578	15	78	41¼		3834	202

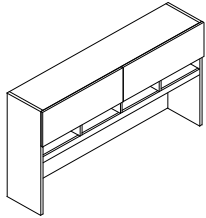

2 bay, 2 flipper doors

Hinged Door Hi-Rise Storage with Organizer Below	xSUD300F-1584	15	84	41¼		4835	220
	xSUD300F-1590	15	90	41¼		4914	233
	xSUD300F-1596	15	96	41¼		4994	246

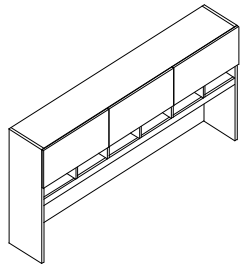

3 bay, 3 flipper doors

(note: all units on this page have unfinished backs)
(see page 60 for detailed top trim)

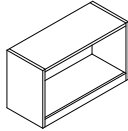
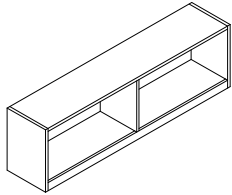
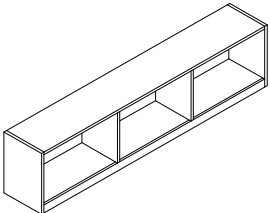
Description	Model Number	Overall Dimensions (in.)			Notes	Price (US\$)	Weight (lbs.)	
		Depth	Width	Height				
	Wall Mount/Spanner Storage	xSWN10-1430	14¼	30	20¾	991	43	
		xSWN10-1436	14¼	36	20¾	1030	49	
		xSWN10-1442	14¼	42	20¾	1073	55	
		xSWN11-1430	14¼	30	32¾	1 adjustable shelf	1199	66
		xSWN11-1436	14¼	36	32¾	1 adjustable shelf	1253	76
		xSWN11-1442	14¼	42	32¾	1 adjustable shelf	1309	85
	1 bay	Please specify Wall Mount or Spanner Cabinet.						
		Wall Mount/Spanner Storage	xSWN20-1448	14¼	48	20¾	1374	67
			xSWN20-1454	14¼	54	20¾	1418	74
		xSWN20-1460	14¼	60	20¾	1457	80	
		xSWN20-1466	14¼	66	20¾	1499	86	
		xSWN20-1472	14¼	72	20¾	1551	92	
		xSWN20-1478	14¼	78	20¾	1593	98	
		xSWN21-1448	14¼	48	32¾	1 adjustable shelf each bay	1733	104
		xSWN21-1454	14¼	54	32¾	1 adjustable shelf each bay	1789	113
		xSWN21-1460	14¼	60	32¾	1 adjustable shelf each bay	1846	123
		xSWN21-1466	14¼	66	32¾	1 adjustable shelf each bay	1899	132
		xSWN21-1472	14¼	72	32¾	1 adjustable shelf each bay	1968	141
		xSWN21-1478	14¼	78	32¾	1 adjustable shelf each bay	2024	151
2 bay		Please specify Wall Mount or Spanner Cabinet.						
		Wall Mount/Spanner Storage	xSWN30-1484	14¼	84	20¾	1897	110
			xSWN30-1490	14¼	90	20¾	1937	116
		xSWN30-1496	14¼	96	20¾	1980	123	
		xSWN31-1484	14¼	84	32¾	1 adjustable shelf each bay	2447	170
		xSWN31-1490	14¼	90	32¾	1 adjustable shelf each bay	2506	179
		xSWN31-1496	14¼	96	32¾	1 adjustable shelf each bay	2563	189
	3 bay	Please specify Wall Mount or Spanner Cabinet.						
							(note: all units on this page have unfinished backs) (see page 60 for detailed top trim)	

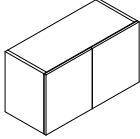
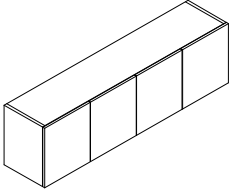
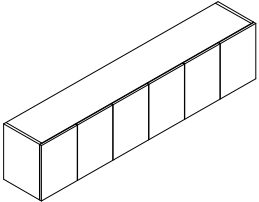
Description	Model Number	Overall Dimensions (in.)			Notes	Price (US\$)	Weight (lbs.)	
		Depth	Width	Height				
Wall Mount/Spanner Storage with Doors 	xSWH10-1530	15	30	20¾		1332	58	
	xSWH10-1536	15	36	20¾		1389	67	
	xSWH10-1542	15	42	20¾		1446	76	
	xSWH11-1530	15	30	32¾	1 adjustable shelf	1587	90	
	xSWH11-1536	15	36	32¾	1 adjustable shelf	1663	104	
	xSWH11-1542	15	42	32¾	1 adjustable shelf	1742	118	
	1 bay, 2 hinged doors		Please specify Wall Mount or Spanner Cabinet.					
	Wall Mount/Spanner Storage with Doors 	xSWH20-1548	15	48	20¾		2033	92
		xSWH20-1554	15	54	20¾		2086	101
xSWH20-1560		15	60	20¾		2143	110	
xSWH20-1566		15	66	20¾		2200	119	
xSWH20-1572		15	72	20¾		2265	128	
xSWH20-1578		15	78	20¾		2322	137	
xSWH21-1548		15	48	32¾	1 adjustable shelf each bay	2458	142	
xSWH21-1554		15	54	32¾	1 adjustable shelf each bay	2538	156	
xSWH21-1560		15	60	32¾	1 adjustable shelf each bay	2617	170	
xSWH21-1566		15	66	32¾	1 adjustable shelf each bay	2693	184	
xSWH21-1572		15	72	32¾	1 adjustable shelf each bay	2784	197	
xSWH21-1578		15	78	32¾	1 adjustable shelf each bay	2863	211	
2 bay, 4 hinged doors		Please specify Wall Mount or Spanner Cabinet.						
Wall Mount/Spanner Storage with Doors 		xSWH30-1584	15	84	20¾		2909	152
		xSWH30-1590	15	90	20¾		2965	161
	xSWH30-1596	15	96	20¾		3022	170	
	xSWH31-1584	15	84	32¾	1 adjustable shelf each bay	3579	236	
	xSWH31-1590	15	90	32¾	1 adjustable shelf each bay	3661	249	
	xSWH31-1596	15	96	32¾	1 adjustable shelf each bay	3741	263	
	3 bay, 6 hinged doors		Please specify Wall Mount or Spanner Cabinet.					
						(note: all units on this page have unfinished backs) (see page 60 for detailed top trim)		

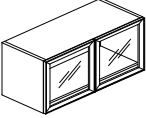
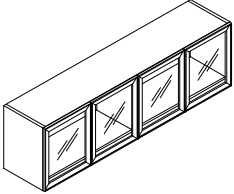
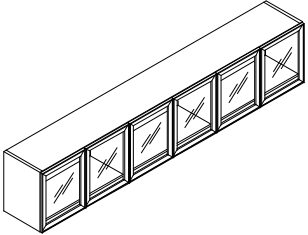
Description	Model Number	Overall Dimensions (in.)			Notes	Price (US\$)	Weight (lbs.)
		Depth	Width	Height			
	xSWH100A-1530	15	30	20¾		2076	71
	xSWH100A-1536	15	36	20¾		2181	83
	xSWH100A-1542	15	42	20¾		2286	95
	xSWH110A-1530	15	30	32¾	1 adjustable shelf	2469	111
	xSWH110A-1536	15	36	32¾	1 adjustable shelf	2625	129
	xSWH110A-1542	15	42	32¾	1 adjustable shelf	2780	147
	1 bay						
	2 metal framed frosted glass doors	Please specify Wall Mount or Spanner Cabinet.					
	<hr/>						
	xSWH200A-1548	15	48	20¾		3421	113
	xSWH200A-1554	15	54	20¾		3526	124
	xSWH200A-1560	15	60	20¾		3631	136
	xSWH200A-1566	15	66	20¾		3736	148
	xSWH200A-1572	15	72	20¾		3851	159
	xSWH200A-1578	15	78	20¾		3956	171
	xSWH210A-1548	15	48	32¾	1 adjustable shelf each bay	4071	175
	xSWH210A-1554	15	54	32¾	1 adjustable shelf each bay	4226	193
	xSWH210A-1560	15	60	32¾	1 adjustable shelf each bay	4383	211
	xSWH210A-1566	15	66	32¾	1 adjustable shelf each bay	4538	229
	xSWH210A-1572	15	72	32¾	1 adjustable shelf each bay	4705	247
	xSWH210A-1578	15	78	32¾	1 adjustable shelf each bay	4862	265
	2 bay						
	4 metal framed frosted glass doors	Please specify Wall Mount or Spanner Cabinet.					
	<hr/>						
	xSWH300A-1584	15	84	20¾		5091	189
	xSWH300A-1590	15	90	20¾		5196	201
	xSWH300A-1596	15	96	20¾		5305	212
	xSWH310A-1584	15	84	32¾	1 adjustable shelf each bay	6154	293
	xSWH310A-1590	15	90	32¾	1 adjustable shelf each bay	6309	311
	xSWH310A-1596	15	96	32¾	1 adjustable shelf each bay	6466	329
	3 bay						
	6 metal framed frosted glass doors	Please specify Wall Mount or Spanner Cabinet.					
						(note: all units on this page have unfinished backs)	
					(see page 60 for detailed top trim)		

Description	Model Number	Overall Dimensions (in.)			Notes	Price (US\$)	Weight (lbs.)
		Depth	Width	Height			
Wall Mount/Spanner Storage with Doors	xSWH100F-1530	15	30	20¾		1649	58
	xSWH100F-1536	15	36	20¾		1708	67
	xSWH100F-1542	15	42	20¾		1767	76

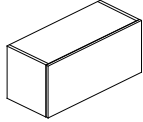

1 bay, 1 flipper door

Please specify Wall Mount or Spanner Cabinet.

Wall Mount/Spanner Storage with Doors	xSWH200F-1548	15	48	20¾		2650	92
	xSWH200F-1554	15	54	20¾		2713	101
	xSWH200F-1560	15	60	20¾		2772	110

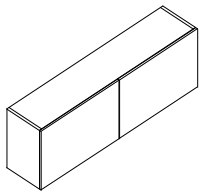

xSWH200F-1566	15	72	20¾		2832	119
xSWH200F-1572	15	78	20¾		2902	128
xSWH200F-1578	15	48	20¾		2965	137

2 bay, 2 flipper doors

Wall Mount/Spanner Storage with Doors	xSWH300F-1584	15	84	20¾		3848	152
	xSWH300F-1590	15	90	20¾		3910	161
	xSWH300F-1596	15	96	20¾		3970	170

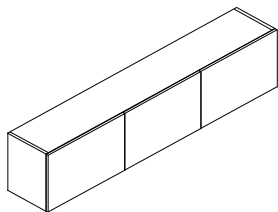

3 bay, 3 flipper doors

Please specify Wall Mount or Spanner Cabinet.

(note: all units on this page have unfinished backs)
(see page 60 for detailed top trim)

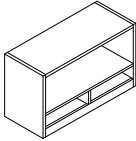
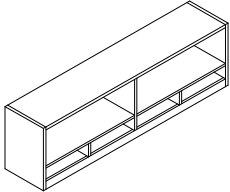
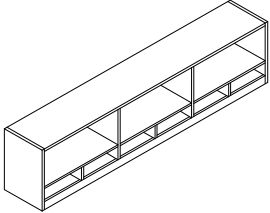
Description	Model Number	Overall Dimensions (in.)			Notes	Price (US\$)	Weight (lbs.)	
		Depth	Width	Height				
Wall Mount/Spanner Storage with Organizer Below 	xSWO10-1430	14¼	30	20¾		1267	52	
	xSWO10-1436	14¼	36	20¾		1318	60	
	xSWO10-1442	14¼	42	20¾		1369	67	
	xSWO11-1430	14¼	30	32¾	1 adjustable shelf	1475	75	
	xSWO11-1436	14¼	36	32¾	1 adjustable shelf	1540	86	
	xSWO11-1442	14¼	42	32¾	1 adjustable shelf	1609	97	
	1 bay Please specify Wall Mount or Spanner Cabinet.							
	Wall Mount/Spanner Storage with Organizer Below 	xSWO20-1448	14¼	48	20¾		1786	81
		xSWO20-1454	14¼	54	20¾		1840	89
xSWO20-1460		14¼	60	20¾		1891	97	
xSWO20-1466		14¼	66	20¾		1941	105	
xSWO20-1472		14¼	72	20¾		2010	113	
xSWO20-1478		14¼	78	20¾		2063	121	
xSWO21-1448		14¼	48	32¾	1 adjustable shelf each bay	2146	118	
xSWO21-1454		14¼	54	32¾	1 adjustable shelf each bay	2211	129	
xSWO21-1460		14¼	60	32¾	1 adjustable shelf each bay	2276	140	
xSWO21-1466		14¼	66	32¾	1 adjustable shelf each bay	2345	151	
xSWO21-1472		14¼	72	32¾	1 adjustable shelf each bay	2427	162	
xSWO21-1478		14¼	78	32¾	1 adjustable shelf each bay	2495	174	
2 bay Please specify Wall Mount or Spanner Cabinet.								
Wall Mount/Spanner Storage with Organizer Below 		xSWO30-1484	14¼	84	20¾		2483	135
		xSWO30-1490	14¼	90	20¾		2535	143
	xSWO30-1496	14¼	96	20¾		2588	151	
	xSWO31-1484	14¼	84	32¾	1 adjustable shelf each bay	3036	194	
	xSWO31-1490	14¼	90	32¾	1 adjustable shelf each bay	3101	205	
	xSWO31-1496	14¼	96	32¾	1 adjustable shelf each bay	3169	217	
	3 bay Please specify Wall Mount or Spanner Cabinet.							
						(note: all units on this page have unfinished backs) (see page 60 for detailed top trim)		

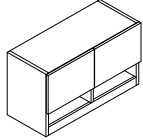
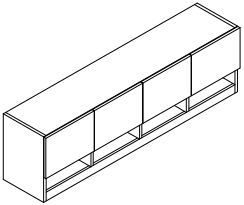
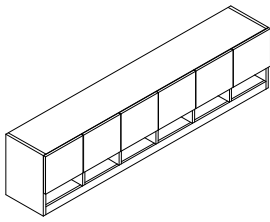
Description	Model Number	Overall Dimensions (in.)			Notes	Price (US\$)	Weight (lbs.)	
		Depth	Width	Height				
Wall Mount/Spanner Storage with Doors and Organizer Below 	xSWD10-1530	15	30	20¾		1614	68	
	xSWD10-1536	15	36	20¾		1679	78	
	xSWD10-1542	15	42	20¾		1747	89	
	xSWD11-1530	15	30	32¾	1 adjustable shelf	1865	99	
	xSWD11-1536	15	36	32¾	1 adjustable shelf	1956	115	
	xSWD11-1542	15	42	32¾	1 adjustable shelf	2043	131	
	1 bay, 2 hinged doors		Please specify Wall Mount or Spanner Cabinet.					
	Wall Mount/Spanner Storage with Doors and Organizer Below 	xSWD20-1548	15	48	20¾		2450	107
		xSWD20-1554	15	54	20¾		2517	118
xSWD20-1560		15	60	20¾		2582	128	
xSWD20-1566		15	66	20¾		2650	139	
xSWD20-1572		15	72	20¾		2735	150	
xSWD20-1578		15	78	20¾		2804	161	
xSWD21-1548		15	48	32¾	1 adjustable shelf each bay	2878	157	
xSWD21-1554		15	54	32¾	1 adjustable shelf each bay	2965	173	
xSWD21-1560		15	60	32¾	1 adjustable shelf each bay	3057	188	
xSWD21-1566		15	66	32¾	1 adjustable shelf each bay	3147	204	
xSWD21-1572		15	72	32¾	1 adjustable shelf each bay	3252	220	
xSWD21-1578		15	78	32¾	1 adjustable shelf each bay	3345	236	
2 bay, 4 hinged doors		Please specify Wall Mount or Spanner Cabinet.						
Wall Mount/Spanner Storage with Doors and Organizer Below 		_SWD30-1584	15	84	20¾		3505	179
		_SWD30-1590	15	90	20¾		3576	189
	_SWD30-1596	15	96	20¾		3645	200	
	_SWD31-1584	15	84	32¾	1 adjustable shelf each bay	4179	262	
	_SWD31-1590	15	90	32¾	1 adjustable shelf each bay	4270	278	
	_SWD31-1596	15	96	32¾	1 adjustable shelf each bay	4361	293	
	3 bay, 6 hinged doors		Please specify Wall Mount or Spanner Cabinet.					
	(note: all units on this page have unfinished backs) (see page 60 for detailed top trim)							

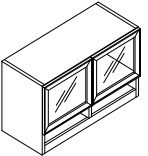
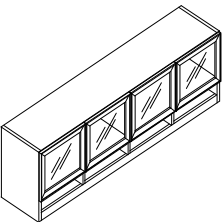
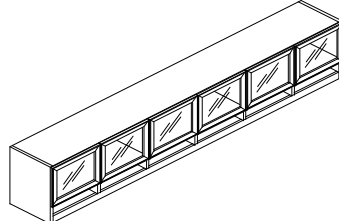
Description	Model Number	Overall Dimensions (in.)			Notes	Price (US\$)	Weight (lbs.)	
		Depth	Width	Height				
Wall Mount/Spanner Storage with Organizer Below 	xSWD100A-1530	15	30	20¾		2358	81	
	xSWD100A-1536	15	36	20¾		2474	94	
	xSWD100A-1542	15	42	20¾		2587	108	
	xSWD110A-1530	15	30	32¾	1 adjustable shelf	2748	120	
	xSWD110A-1536	15	36	32¾	1 adjustable shelf	2915	140	
	xSWD110A-1542	15	42	32¾	1 adjustable shelf	3083	160	
	1 bay							
	2 metal framed frosted glass doors	Please specify Wall Mount or Spanner Cabinet.						
Wall Mount/Spanner Storage with Organizer Below 	xSWD200A-1548	15	48	20¾		3841	128	
	xSWD200A-1554	15	54	20¾		3954	141	
	xSWD200A-1560	15	60	20¾		4070	155	
	xSWD200A-1566	15	66	20¾		4186	168	
	xSWD200A-1572	15	72	20¾		4320	182	
	xSWD200A-1578	15	78	20¾		4436	195	
	xSWD210A-1548	15	48	32¾	1 adjustable shelf each bay	4490	190	
	xSWD210A-1554	15	54	32¾	1 adjustable shelf each bay	4657	210	
	xSWD210A-1560	15	60	32¾	1 adjustable shelf each bay	4822	230	
	xSWD210A-1566	15	66	32¾	1 adjustable shelf each bay	4989	250	
	xSWD210A-1572	15	72	32¾	1 adjustable shelf each bay	5173	269	
	xSWD210A-1578	15	78	32¾	1 adjustable shelf each bay	5340	289	
	2 bay							
	4 metal framed frosted glass doors	Please specify Wall Mount or Spanner Cabinet.						
	Wall Mount/Spanner Storage with Organizer Below 	xSWD300A-1584	15	84	20¾		5689	215
		xSWD300A-1590	15	90	20¾		5804	229
		xSWD300A-1596	15	96	20¾		5924	242
xSWD310A-1584		15	84	32¾	1 adjustable shelf each bay	6750	320	
xSWD310A-1590		15	90	32¾	1 adjustable shelf each bay	6918	339	
xSWD310A-1596		15	96	32¾	1 adjustable shelf each bay	7085	359	
3 bay								
6 metal framed frosted glass doors		Please specify Wall Mount or Spanner Cabinet.						
					(note: all units on this page have unfinished backs) (see page 60 for detailed top trim)			

Description	Model Number	Overall Dimensions (in.)			Notes	Price (US\$)	Weight (lbs.)
		Depth	Width	Height			
Wall Mount/Spanner Storage with Doors and Organizer Below	xSWD100F-1530	15	30	20¾		1928	68
	xSWD100F-1536	15	36	20¾		2001	78
	xSWD100F-1542	15	42	20¾		2072	89

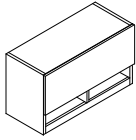

1 bay, 1 flipper door

Please specify Wall Mount or Spanner Cabinet.

Wall Mount/Spanner Storage with Doors and Organizer Below	xSWD200F-1548	15	48	20¾		3070	107
	xSWD200F-1554	15	54	20¾		3141	118
	xSWD200F-1560	15	60	20¾		3212	128
	xSWD200F-1566	15	66	20¾		3282	139
	xSWD200F-1572	15	72	20¾		3374	150
	xSWD200F-1578	15	78	20¾		3444	161

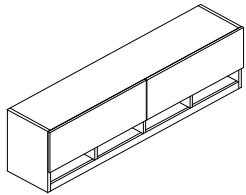

2 bay, 2 flipper doors

Please specify Wall Mount or Spanner Cabinet.

Wall Mount/Spanner Storage with Doors and Organizer Below	xSWD300F-1584	15	84	20¾		4445	179
	xSWD300F-1590	15	90	20¾		4519	189
	xSWD300F-1596	15	96	20¾		4593	200

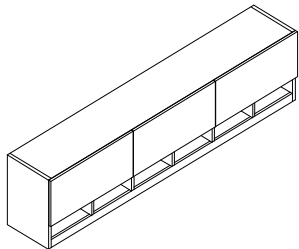

3 bay, 3 flipper doors

Please specify Wall Mount or Spanner Cabinet.

(note: all units on this page have unfinished backs)
(see page 60 for detailed top trim)

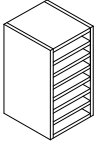
Description	Model Number	Overall Dimensions (in.)			Notes	Price (US\$)	Weight (lbs.)
		Depth	Width	Height			
	xSPS-1211	12¼	11	20	6-9½" w fixed shelves	717	28
	xSPS-1216	12¼	15¾	20	6-9½" w fixed shelves	893	37
	xSPS-1219	12¼	18¾	20	6-9½" w fixed shelves	995	42

Open with horizontal dividers

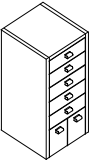

	xSPI-1211	12¼	11	20	6-9½" w fixed shelves 2-4" w drawers	840	31
	xSPI-1216	12¼	15¾	20	6-9½" w fixed shelves 2-4" w drawers	1009	40
	xSPI-1219	12¼	18¾	20	6-9½" w fixed shelves 2-4" w drawers	1110	46

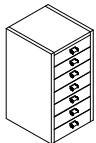
Combination open and 1 drawer

	xSPK-1211	12¼	11	20	7-8½" w drawers	986	31
	xSPK-1216	12¼	15¾	20	7-8½" w drawers	1170	41
	xSPK-1219	12¼	18¾	20	7-8½" w drawers	1279	46

All flat drawers

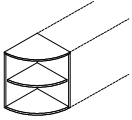
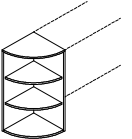
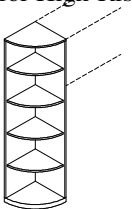
(note: all units on this page have unfinished backs)

Description	Model Number	Overall Dimensions (in.)			Notes	Price (US\$)	Weight (lbs.)
		Depth	Width	Height			
Bend Shelving for Wall Mount Storage 	xSEW100L-141421	14¼	14¼	20¾	bottom shelf only	689	23
	xSEW110L-141433	14¼	14¼	32¾	bottom shelf plus 1 fixed shelf	977	34
	xWCF1A-1515	15	15	1½	top cap with edge profile	240	8
Specify Left or Right	(Left indicated)				back painted black		
Bend Shelving for High-Rise Applications 	xSET120L-141441	14¼	14¼	41¼	bottom shelf plus 2 fixed shelves	1201	43
	xSET130L-141453	14¼	14¼	53¼	bottom shelf plus 3 fixed shelves	1487	54
	xWCF1A-1515	15	15	1½	top cap with edge profile	240	8
Specify Left or Right	(Left indicated)				back painted black		
Bend Shelving for High-Rise Applications 	xSE0140L-141471	14¼	14¼	70½	2¾ base plus 4 fixed shelves	1930	76
	xSE0150L-141483	14¼	14¼	82½	2¾ base plus 5 fixed shelves	2222	88
	xSE0140L-241471	24¼	14¼	70½	2¾ base plus 4 fixed shelves	2297	126
	xSE0150L-241483	24¼	14¼	82½	2¾ base plus 5 fixed shelves	2632	146
	xWCF1A-1515	15	15	1½	top cap with edge profile	240	8
	xWCF1A-2515	25	15	1½	top cap with edge profile	287	13
Specify Left or Right	(Left indicated)				back painted black		
Bend Shelving for High-Rise Applications - Desktop 	xSPE110-121220	12¼	12¼	20	1 fixed shelf	777	18
	xSPE160-121220	12¼	12¼	20	6 fixed sorter shelves	845	30
Unhanded					finished 3 sides and top		

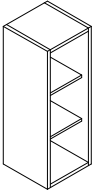
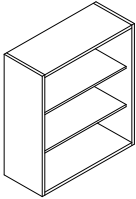
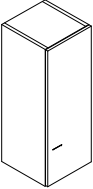
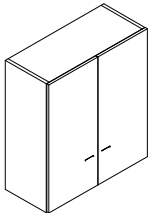
Description	Model Number	Overall Dimensions (in.)			Notes	Price (US\$)	Weight (lbs.)
		Depth	Width	Height			
	xSUS12-1415	14¼	15	41¼	2 adjustable shelves	1424	54
	xSUS12-1418	14¼	18	41¼	2 adjustable shelves	1454	60
	xSUS13-1415	14¼	15	53¼	3 adjustable shelves	1595	69
	xSUS13-1418	14¼	18	53¼	3 adjustable shelves	1632	77
	xSUS12-1430	14¼	30	41¼	2 adjustable shelves	1576	85
	xSUS12-1436	14¼	36	41¼	2 adjustable shelves	1639	97
	xSUS13-1430	14¼	30	53¼	3 adjustable shelves	1785	108
	xSUS13-1436	14¼	36	53¼	3 adjustable shelves	1862	123
	xSUT12-1515- R	15	15	41¼	2 adjustable shelves	1768	70
	xSUT12-1518- R	15	18	41¼	2 adjustable shelves	1813	79
	xSUT13-1515- R	15	15	53¼	3 adjustable shelves	1976	90
	xSUT13-1518- R	15	18	53¼	3 adjustable shelves	2033	101
Specify L or R hinged door (right shown)							
	xSUT12-1530	15	30	41¼	2 adjustable shelves	1995	114
	xSUT12-1536	15	36	41¼	2 adjustable shelves	2082	132
	xSUT13-1530	15	30	53¼	3 adjustable shelves	2256	146
	xSUT13-1536	15	36	53¼	3 adjustable shelves	2370	169
(note: all units on this page have unfinished backs)							

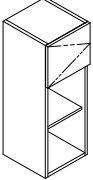
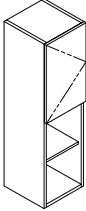
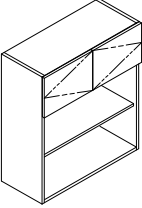
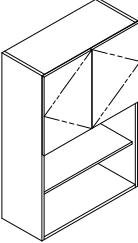
Description	Model Number	Overall Dimensions (in.)			Notes	Price (US\$)	Weight (lbs.)
		Depth	Width	Height			
Tower Anchor with Door 	xSUP101-1515-R	15	15	41¼	1 adjustable shelf below door	1474	63
	xSUP101-1518-R	15	18	41¼	1 adjustable shelf below door	1511	71
Specify Left or Right hinged door (right shown)					(upper doors align with upper storage)		
Tower Anchor with Door 	xSUP111-1515-R	15	15	53¼	1 adjustable shelf behind door and 1 below	1755	83
	xSUP111-1518-R	15	18	53¼	1 adjustable shelf behind door and 1 below	1803	93
Specify Left or Right hinged door (right shown)					(upper doors align with upper storage)		
Tower Anchor with Doors 	xSUP101-1530	15	30	41¼	1 adjustable shelf below door	1664	101
	xSUP101-1536	15	36	41¼	1 adjustable shelf below door	1740	116
					(upper doors align with upper storage)		
Tower Anchor with Doors 	xSUP111-1530	15	30	53¼	1 adjustable shelf behind door and 1 below	2001	133
	xSUP111-1536	15	36	53¼	1 adjustable shelf behind door and 1 below	2101	152
(note: all units on this page have unfinished backs)					(upper doors align with upper storage)		

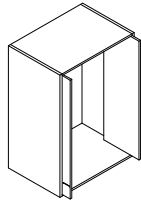
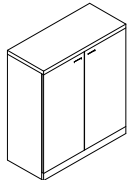
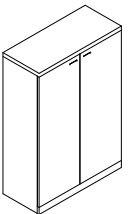
Description	Model Number	Overall Dimensions (in.)			Notes	Price (US\$)	Weight (lbs.)
		Depth	Width	Height			
Upper Storage Video Cabinet with Full Height Retractable Doors 	xSUT10R-2030	20	30	41¼		2844	145
	xSUT10R-2036	20	36	41¼		2921	160
	xSUT10R-2530	25	30	41¼		2964	168
	xSUT10R-2536	25	36	41¼		3049	184
	xSUT10R-2030	20	30	53¼		3024	180
	xSUT10R-2036	20	36	53¼		3114	198
	xSUT10R-2530	25	30	53¼		3171	208
	xSUT10R-2536	25	36	53¼		3268	227
Unit to sit on credenza							
Hinged Door Storage 	xSHU12-1630	16	30⅞	42¾		1848	112
	xSHU12-1636	16	36⅞	42¾		1998	129
	xSHU12-2030	20	30⅞	42¾		1978	134
	xSHU12-2036	20	36⅞	42¾		2137	153
	xSHU12-2430	24	30⅞	42¾		2105	155
	xSHU12-2436	24	36⅞	42¾		2271	177
2 adjustable shelves Includes full 1½" overlay top		Free standing unit					
Hinged Door Storage 	xSHU13-1630	16	30⅞	55		2313	138
	xSHU13-1636	16	36⅞	55		2482	158
	xSHU13-2030	20	30⅞	55		2462	164
	xSHU13-2036	20	36⅞	55		2646	187
	xSHU13-2430	24	30⅞	55		2613	189
	xSHU13-2436	24	36⅞	55		2808	216
3 adjustable shelves Includes full 1½" overlay top		Free standing unit (note: all units on this page have unfinished backs)					

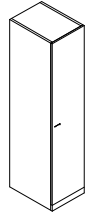
Description	Model Number	Overall Dimensions (in.)			Notes	Price (US\$)	Weight (lbs.)
		Depth	Width	Height			
	xSHU14-1516- R	15	15¾	70½		2373	106
	xSHU14-1519- R	15	18¾	70½		2474	118
	xSHU14-2516- R	25	15¾	70½		2731	162
	xSHU14-2519- R	25	18¾	70½		2849	178

4 adjustable shelves Specify **Left** or **Right** hinged door (right shown)

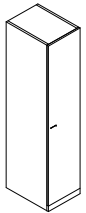
	xSHU15-1516- R	15	15¾	82½		2780	123
	xSHU15-1519- R	15	18¾	82½		2894	136
	xSHU15-2516- R	25	15¾	82½		3179	186
	xSHU15-2519- R	25	18¾	82½		3316	205

5 adjustable shelves Specify **Left** or **Right** hinged door (right shown)

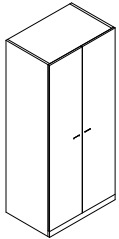
	xSHU14-2530	25	30	70½	4 adjustable shelves	3287	238
	xSHU14-2536	25	36	70½	4 adjustable shelves	3523	271
	xSHU15-2530	25	30	82½	5 adjustable shelves	3804	274
	xSHU15-2536	25	36	82½	5 adjustable shelves	4072	311

(note: all units on this page have unfinished backs)

Description	Model Number	Overall Dimensions (in.)			Notes	Price (US\$)	Weight (lbs.)
		Depth	Width	Height			
	xSCU11-2516-R	25	15¾	70½		2087	152
	xSCU11-2519-R	25	18¾	70½		2184	166
	xSCU11-2516-R	25	15¾	82½		2306	172
	xSCU11-2519-R	25	18¾	82½		2413	188

Coat Bar and 1 shelf Specify Left or Right hinged door (right shown)

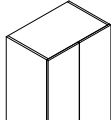
	Wardrobe/Storage	xSDU24-2530	25	30	70½	4 adjustable shelves on right half coat rod on left half	3821	304
		xSDU24-2536	25	36	70½	4 adjustable shelves on right half coat rod on left half	4057	342
		xSDU25-2530	25	30	82½	full width coat rod and hat shelf inside	4387	353
		xSDU25-2536	25	36	82½	full width coat rod and hat shelf inside	4655	398

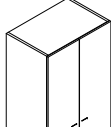
	Wardrobe	xSCU11-2530	25	30	70½	5 adjustable shelves on right half coat rod on left	2543	220
		xSCU11-2536	25	36	70½	5 adjustable shelves on right half coat rod on left	2734	249
		xSCU11-2530	25	30	82½	full width coat rod and hat shelf inside	2793	248
		xSCU11-2536	25	36	82½	full width coat rod and hat shelf inside	3002	280

(note: all units on this page have unfinished backs)

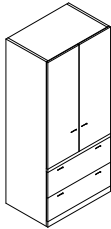
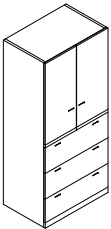
Description	Model Number	Overall Dimensions (in.)			Notes	Price (US\$)	Weight (lbs.)
		Depth	Width	Height			
Combination File/Storage 	xSSU122-2519-R	25	18¾	70½	2 adjustable shelves above 2 legal width file drawers below	3623	216
	xSSU132-2519-R	25	18¾	82½	3 adjustable shelves above 2 legal width file drawers below	4087	248
Specify Left or Right hinged door (right shown)							
Combination File/Storage 	xSSU122-2530	25	30	70½	2 adjustable shelves above 2- 30" w lateral file drawers below	4038	281
	xSSU122-2536	25	36	70½	2 adjustable shelves above 2- 36" w lateral file drawers below	4263	317
	xSSU132-2530	25	30	82½	3 adjustable shelves above 2- 30" w lateral file drawers below	4555	324
	xSSU132-2536	25	36	82½	3 adjustable shelves above 2- 36" w lateral file drawers below	4809	366
Combination File/Storage 	xSSU113-2530	25	30	70½	1 adjustable shelf above 3- 30" w lateral file drawers below	4368	281
	xSSU113-2536	25	36	70½	1 adjustable shelf above 3- 36" w lateral file drawers below	4576	313
	xSSU123-2530	25	30	82½	2 adjustable shelves above 3- 30" w lateral file drawers below	4874	324
	xSSU123-2536	25	36	82½	2 adjustable shelves above 3- 36" w lateral file drawers below	5111	362

(note: all units on this page have unfinished backs)

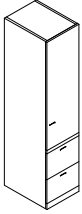
Description	Model Number	Overall Dimensions (in.)			Notes	Price (US\$)	Weight (lbs.)
		Depth	Width	Height			
Combination File/Wardrobe	xSQU102-2519-R	25	18¾	70½	coat bar above, 2 legal width files below	3191	196
	xSQU112-2519-R	25	18¾	82½	coat bar & shelf above, 2 legal width files below	3644	228
							
Specify Left or Right hinged door (right shown)							

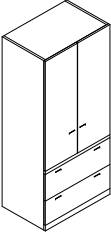
Combination File/Wardrobe	xSQU102-2530	25	30	70½	coat bar above, 2 lateral files below	3547	250
	xSQU102-2536	25	36	70½	coat bar above, 2 lateral files below	3740	279
	xSQU112-2530	25	30	82½	coat bar & shelf above, 2 lateral files below	4053	293
	xSQU112-2536	25	36	82½	coat bar & shelf above, 2 lateral files below	4276	328
							

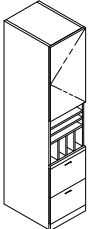
Combination File/Storage/Sorter	xSYU102-2516-L	25	15¾	71		3743	227
	xSYU102-2519-L	25	18¾	71		3877	248
	xSYU112-2516-L	25	15¾	83	1 adjustable shelf inside cabinet	4157	252
	xSYU112-2519-L	25	18¾	83	1 adjustable shelf inside cabinet	4304	275
							

2 legal width lateral file drawers below
Specify **Left** or **Right** hinged door (left shown)

(note: all units on this page have unfinished backs)

Description	Model Number	Overall Dimensions (in.)			Notes	Price (US\$)	Weight (lbs.)
		Depth	Width	Height			
Video Cabinet - Hinged	xSVU121-2530	25	30	70½	2 adjustable shelves above, 1 below	3431	238
Doors over Hinged Doors	xSVU121-2536	25	36	70½	2 adjustable shelves above, 1 below	3668	271
	xSVU131-2530	25	30	82½	3 adjustable shelves above, 1 below	4124	274
	xSVU131-2536	25	36	82½	3 adjustable shelves above, 1 below	4390	311

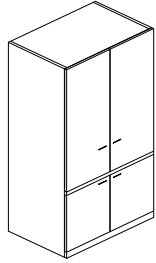

Video Cabinet - Upper Retractable	xVHR01-2530-0-VS2	25	30	70½	1 adjustable shelf below	4346	310
Doors over Hinged Doors	xVHR01-2536-0-VS2	25	36	70½	1 adjustable shelf below	4581	342
	xVHR01-2530-0-VS2	25	30	82½	1 adjustable shelf below	4599	350
	xVHR01-2536-0-VS2	25	36	82½	1 adjustable shelf below	4853	385

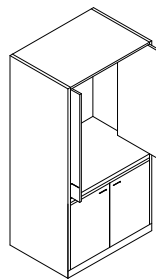

includes 2 ventilation slots

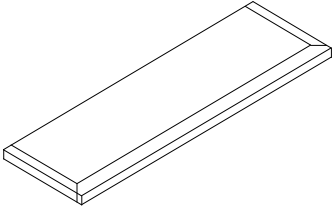
Description	Model Number	Overall Dimensions (in.)			Notes	Price (US\$)	Weight (lbs.)
		Depth	Width	Height			
Top Cap 	_WCF1-1530	15	30	1½	for unit without doors	300	16
	_WCF1-1536	15	36	1½	for unit without doors	331	19
	_WCF1-1542	15	42	1½	for unit without doors	355	22
	_WCF1-1548	15	48	1½	for unit without doors	381	25
	_WCF1-1554	15	54	1½	for unit without doors	404	28
	_WCF1-1560	15	60	1½	for unit without doors	432	31
	_WCF1-1566	15	66	1½	for unit without doors	458	34
	_WCF1-1572	15	72	1½	for unit without doors	482	38
	_WCF1-1578	15	78	1½	for unit without doors	508	41
	_WCF1-1584	15	84	1½	for unit without doors	532	44
	_WCF1-1590	15	90	1½	for unit without doors	558	47
	_WCF1-1596	15	96	1½	for unit without doors	582	50
	_WCF1-15108	15	108	1½	for unit without doors	635	56
	_WCF1-1615	16	15	1½	for unit with doors	244	8
	_WCF1-1616	16	16	1½	for unit with doors	250	9
	_WCF1-1618	16	18	1½	for unit with doors	257	10
	_WCF1-1619	16	19	1½	for unit with doors	260	11
	_WCF1-1630	16	30	1½	for unit with doors	308	17
	_WCF1-1636	16	36	1½	for unit with doors	334	20
	_WCF1-1642	16	42	1½	for unit with doors	361	23
	_WCF1-1648	16	48	1½	for unit with doors	384	27
	_WCF1-1654	16	54	1½	for unit with doors	411	30
	_WCF1-1660	16	60	1½	for unit with doors	434	33
	_WCF1-1666	16	66	1½	for unit with doors	465	37
	_WCF1-1672	16	72	1½	for unit with doors	488	40
	_WCF1-1678	16	78	1½	for unit with doors	515	43
	_WCF1-1684	16	84	1½	for unit with doors	538	47
	_WCF1-1690	16	90	1½	for unit with doors	562	50
	_WCF1-1696	16	96	1½	for unit with doors	591	53
	_WCF1-16108	16	108	1½	for unit with doors	642	60
	_WCF1-2116	21	16	1½	for unit with doors	273	12
	_WCF1-2119	21	19	1½	for unit with doors	284	14
	_WCF1-2130	21	30	1½	for unit with doors	333	22
	_WCF1-2136	21	36	1½	for unit with doors	360	26
	Used to add detail to upper storage and anchor units without full overlay tops	_WCF1-2616	26	16	1½	for unit with doors	296
_WCF1-2619		26	19	1½	for unit with doors	309	17
_WCF1-2630		26	30	1½	for unit with doors	359	27
Profile front edge only	_WCF1-2636	26	36	1½	for unit with doors	383	33

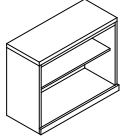
Description	Model Number	Overall Dimensions (in.)			Notes	Price (US\$)	Weight (lbs.)
		Depth	Width	Height			
	xSBU11-1530	15	30 ¹ / ₈	27 ³ / ₄	matches pedestals, 1 shelf at 10 ⁵ / ₈ " and one at 11 ⁷ / ₈ " clear height *	992	63
	xSBU11-1536	15	36 ¹ / ₈	27 ³ / ₄		1037	72
	_SBU11-1530	15 ¹ / ₈	30 ¹ / ₈	29 ¹ / ₄	both shelf openings at 11 ⁷ / ₈ " clear **	1027	71
	_SBU11-1536	15 ¹ / ₈	36 ¹ / ₈	29 ¹ / ₄	both shelf openings at 11 ⁷ / ₈ " clear **	1080	81

*unit has unfinished top
** unit has full 1¹/₂" detailed overlay top

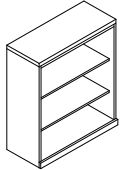
	_SBU12-1530	15 ¹ / ₈	30 ¹ / ₈	42 ³ / ₄	2 adjustable shelves	1255	98
	_SBU12-1536	15 ¹ / ₈	36 ¹ / ₈	42 ³ / ₄	2 adjustable shelves	1323	112
	_SBU13-1530	15 ¹ / ₈	30 ¹ / ₈	55	3 adjustable shelves	1469	122
	_SBU13-1536	15 ¹ / ₈	36 ¹ / ₈	55	3 adjustable shelves	1554	139

Includes full 1¹/₂" overlay top

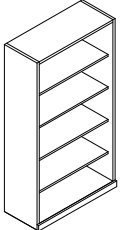
	xSBU14-1530	15	30 ¹ / ₈	70 ¹ / ₂	4 adjustable shelves	1731	151
	xSBU14-1536	15	36 ¹ / ₈	70 ¹ / ₂	4 adjustable shelves	1833	173

(See page 60 for top trim options.)
(note: all units on this page have unfinished backs)

No overlay top

Description	Model Number	Overall Dimensions (in.)			Notes	Price (US\$)	Weight (lbs.)
		Depth	Width	Height			
Bookcase	xSBU15-1530	15	30 $\frac{1}{8}$	82 $\frac{1}{2}$	5 adjustable shelves	1949	176
	xSBU15-1536	15	36 $\frac{1}{8}$	82 $\frac{1}{2}$	5 adjustable shelves	2067	200

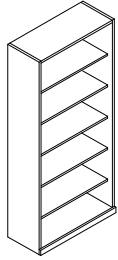

No overlay top

Bookcase	xSBU21-1560	15 $\frac{1}{8}$	60 $\frac{1}{8}$	27 $\frac{3}{4}$	matches pedestals, one shelf at 10 $\frac{5}{8}$ " and one at 11 $\frac{7}{8}$ " clear height *	1591	118
	xSBU21-1572	15 $\frac{1}{8}$	72 $\frac{1}{8}$	27 $\frac{3}{4}$		1696	136
	_SBU21-1560	15 $\frac{1}{8}$	60 $\frac{1}{8}$	29 $\frac{1}{4}$	both shelf openings at 11 $\frac{7}{8}$ " clear **	1653	132
	_SBU21-1572	15 $\frac{1}{8}$	72 $\frac{1}{8}$	29 $\frac{1}{4}$	both shelf openings at 11 $\frac{7}{8}$ " clear **	1766	153

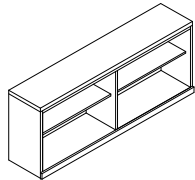

unit has unfinished top
unit has full 1 $\frac{1}{2}$ " overlay top

1 adjustable shelf each bay

Bookcase	_SBU22-1560	15 $\frac{1}{8}$	60 $\frac{1}{8}$	42 $\frac{3}{4}$		2061	179
	_SBU22-1572	15 $\frac{1}{8}$	72 $\frac{1}{8}$	42 $\frac{3}{4}$		2209	207

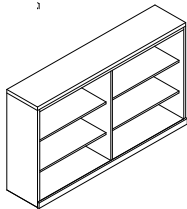

2 adjustable shelves each bay
Includes full 1 $\frac{1}{2}$ " overlay top

(note: all units on this page have unfinished backs)

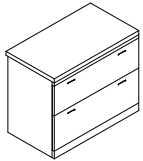
Description	Model Number	Overall Dimensions (in.)			Notes	Price (US\$)	Weight (lbs.)
		Depth	Width	Height			
	_C000N-2030-E	20	30 ¹ / ₈	29 ¹ / ₄		1842	121
	_C000N-2036-F	20	36 ¹ / ₈	29 ¹ / ₄		1888	125
	_C000N-2430-E	24	30 ¹ / ₈	29 ¹ / ₄		1928	125
	_C000N-2436-F	24	36 ¹ / ₈	29 ¹ / ₄		1979	130

Unfinished back
Includes full 1½” overlay top

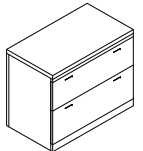
	_C000L-2030-E	20	30 ¹ / ₈	29 ¹ / ₄		2134	138
	_C000L-2036-F	20	36 ¹ / ₈	29 ¹ / ₄		2217	146
	_C000L-2430-E	24	30 ¹ / ₈	29 ¹ / ₄		2230	143
	_C000L-2436-F	24	36 ¹ / ₈	29 ¹ / ₄		2317	151

Full finished back
Includes full 1½” overlay top

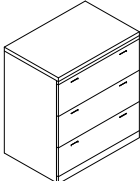
	_SFU103-2030	20	30 ¹ / ₈	42 ³ / ₄		2544	154
	_SFU103-2036	20	36 ¹ / ₈	42 ³ / ₄		2622	168

Unfinished back
Includes full 1½” overlay top

Description	Model Number	Overall Dimensions (in.)			Notes	Price (US\$)	Weight (lbs.)
		Depth	Width	Height			
4 Drawer Lateral File	_SFU104-2030	20	30 ¹ / ₈	55		3220	186
	_SFU104-2036	20	36 ¹ / ₈	55		3306	202

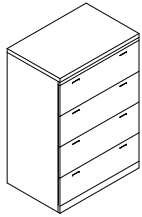

Unfinished back
Includes full 1½” detailed overlay top

Freestanding Storage Credenza	_C000N-2060-EE	20	60 ¹ / ₈	29 ¹ / ₄		3403	242
	_C000N-2072-FF	20	72 ¹ / ₈	29 ¹ / ₄		3512	250
	_C000N-2460-EE	24	60 ¹ / ₈	29 ¹ / ₄		3561	250
	_C000N-2472-FF	24	72 ¹ / ₈	29 ¹ / ₄		3675	260

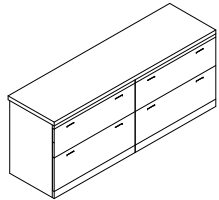

Unfinished back
Includes full 1½” overlay top

Freestanding Storage Credenza	_C000L-2060-EE	20	60 ¹ / ₈	29 ¹ / ₄		3852	277
	_C000L-2072-FF	20	72 ¹ / ₈	29 ¹ / ₄		4028	292
	_C000L-2460-EE	24	60 ¹ / ₈	29 ¹ / ₄		4023	285
	_C000L-2472-FF	24	72 ¹ / ₈	29 ¹ / ₄		4202	302

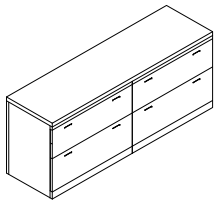

Full finished back
Includes full 1½” overlay top

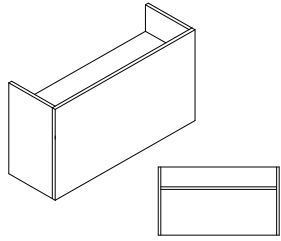
Description	Model Number	Overall Dimensions (in.)			Notes	Price (US\$)	Weight (lbs.)
		Depth	Width	Height			
	xD0R-2460-0-GL2	24	60	41¼		2724	204
	xD0R-2466-0-GL2	24	66	41¼		2834	217
	xD0R-2472-0-GL2	24	72	41¼		2954	231
	xD0R-2478-0-GL2	24	78	41¼		3064	244
	xD0R-2484-0-GL2	24	84	41¼		3174	258
	xD0R-2490-0-GL2	24	90	41¼		3283	271
	xD0R-2496-0-GL2	24	96	41¼		3396	285
	xD0R-3060-0-GL2	30	60	41¼		2891	233
	xD0R-3066-0-GL2	30	66	41¼		3007	248
	xD0R-3072-0-GL2	30	72	41¼		3132	263
	xD0R-3078-0-GL2	30	78	41¼		3249	278
	xD0R-3084-0-GL2	30	84	41¼		3362	293
	xD0R-3090-0-GL2	30	90	41¼		3476	307
	xD0R-3096-0-GL2	30	96	41¼		3591	322

Includes 2 grommets

(note: no profile detail available)

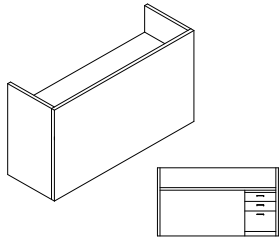
	xD0R-2466-AR-GL2	24	66	41¼	letter width b/b/f pedestal	3936	297
	xD0R-2472-CR-GL2	24	72	41¼	legal width b/b/f pedestal	4055	311
	xD0R-2478-CR-GL2	24	78	41¼	legal width b/b/f pedestal	4166	324
	xD0R-2484-CR-GL2	24	84	41¼	legal width b/b/f pedestal	4277	338
	xD0R-2490-CR-GL2	24	90	41¼	legal width b/b/f pedestal	4388	351
	xD0R-2496-CR-GL2	24	96	41¼	legal width b/b/f pedestal	4497	365
	xD0R-3066-AR-GL2	30	66	41¼	letter width b/b/f pedestal	4158	328
	xD0R-3072-CR-GL2	30	72	41¼	legal width b/b/f pedestal	4286	343
	xD0R-3078-CR-GL2	30	78	41¼	legal width b/b/f pedestal	4403	358
	xD0R-3084-CR-GL2	30	84	41¼	legal width b/b/f pedestal	4514	373
	xD0R-3090-CR-GL2	30	90	41¼	legal width b/b/f pedestal	4629	387
	xD0R-3096-CR-GL2	30	96	41¼	legal width b/b/f pedestal	4746	402

Includes 2 grommets

Specify **L**eft or **R**ight (seated)

(**R**ight indicated)

(note: no profile detail available)

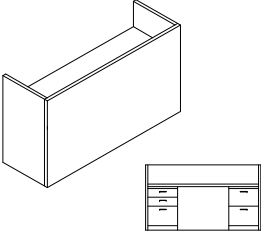
Description	Model Number	Overall Dimensions (in.)			Notes	Price (US\$)	Weight (lbs.)
		Depth	Width	Height			
	xD0R-2466-AKB-GL2	24	66	41¼	letter width b/b/f and f/f pedestals	5039	377
	xD0R-2472-CKD-GL2	24	72	41¼	legal width b/b/f and f/f pedestals	5159	391
	xD0R-2478-CKD-GL2	24	78	41¼	legal width b/b/f and f/f pedestals	5269	404
	xD0R-2484-CKD-GL2	24	84	41¼	legal width b/b/f and f/f pedestals	5379	418
	xD0R-2490-CKD-GL2	24	90	41¼	legal width b/b/f and f/f pedestals	5492	431
	xD0R-2496-CKD-GL2	24	96	41¼	legal width b/b/f and f/f pedestals	5601	445
	xD0R-3066-AKB-GL2	30	66	41¼	letter width b/b/f and f/f pedestals	5314	408
	xD0R-3072-CKD-GL2	30	72	41¼	legal width b/b/f and f/f pedestals	5441	423
	xD0R-3078-CKD-GL2	30	78	41¼	legal width b/b/f and f/f pedestals	5555	438
	xD0R-3084-CKD-GL2	30	84	41¼	legal width b/b/f and f/f pedestals	5669	453
	xD0R-3090-CKD-GL2	30	90	41¼	legal width b/b/f and f/f pedestals	5784	467
	xD0R-3096-CKD-GL2	30	96	41¼	legal width b/b/f and f/f pedestals	5901	482

Includes 2 grommets

(note: no profile detail available)

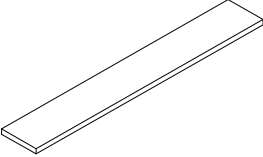
	_WA11-1166	11	66⅞	1½		387	25
	_WA11-1172	11	72⅞	1½		404	28
	_WA11-1178	11	78⅞	1½		418	30
	_WA11-1184	11	84⅞	1½		433	32
	_WA11-1190	11	90⅞	1½		446	34
	_WA11-1196	11	96⅞	1½		461	37
	_WA11-11102	11	102⅞	1½		475	39
	_WA11-11108	11	108⅞	1½		489	41

Detail approach side only

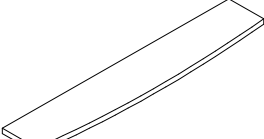
	_WA11F-1366	13	66⅞	1½		435	30
	_WA11F-1472	13½	72⅞	1½		469	35
	_WA11F-1478	14	78⅞	1½		486	38
	_WA11F-1584	14½	84⅞	1½		518	44
	_WA11F-1590	15	90⅞	1½		538	47
	_WA11F-1696	15½	96⅞	1½		568	53
	_WA11F-16102	16	102⅞	1½		588	57
	_WA11F-17108	16½	108⅞	1½		625	64

Detail approach side only

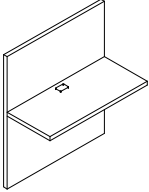
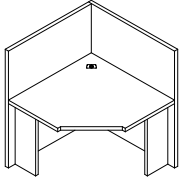
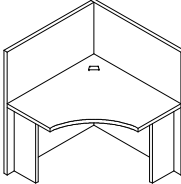
Description	Model Number	Overall Dimensions (in.)			Notes	Price (US\$)	Weight (lbs.)	
		Depth	Width	Height				
	xB0R-2036-0-GL1	20	36	41¼		1229	76	
	xB0R-2042-0-GL1	20	42	41¼		1338	89	
	xB0R-2048-0-GL1	20	48	41¼		1442	102	
	xB0R-2054-0-GL1	20	54	41¼		1548	114	
	xB0R-2436-0-GL1	24	36	41¼		1288	81	
	xB0R-2442-0-GL1	24	42	41¼		1398	95	
	xB0R-2448-0-GL1	24	48	41¼		1506	108	
	xB0R-2454-0-GL1	24	54	41¼		1615	122	
	xB0R-3036-0-GL1	30	36	41¼		1376	89	
	xB0R-3042-0-GL1	30	42	41¼		1489	104	
	xB0R-3048-0-GL1	30	48	41¼		1601	118	
	xB0R-3054-0-GL1	30	54	41¼		1716	133	
	Includes 1 grommet - center					(note: no profile detail available)		
	 <p>Seated Diagonal</p>  <p>Seated Radius</p>	xBCRA-3636-0-GL1	36	36	41¼	connects to 20" both sides	2472	245
xBCRB-3636-0-GL1		36	36	41¼	connects to 24" both sides	2472	245	
xBCRD-3636-0-GL1		36	36	41¼	connects to 20" on left and 24" on right	2472	245	
xBCRE-3636-0-GL1		36	36	41¼	connects to 24" on left and 20" on right	2472	245	
xBCRA-4242-0-GL1		42	42	41¼	connects to 20" both sides	2828	295	
xBCRB-4242-0-GL1		42	42	41¼	connects to 24" both sides	2828	295	
xBCRC-4242-0-GL1		42	42	41¼	connects to 30" both sides	2828	295	
xBCRD-4242-0-GL1		42	42	41¼	connects to 20" on left and 24" on right	2828	295	
xBCRE-4242-0-GL1		42	42	41¼	connects to 24" on left and 20" on right	2828	295	
xBCRA0D-3636-0-GL1		36	36	41¼	connects to 20" both sides	2550	245	
xBCRB0D-3636-0-GL1		36	36	41¼	connects to 24" both sides	2550	245	
xBCRD0D-3636-0-GL1		36	36	41¼	connects to 20" on left and 24" on right	2550	245	
xBCRE0D-3636-0-GL1		36	36	41¼	connects to 24" on left and 20" on right	2550	245	
xBCRA0D-4242-0-GL1		42	42	41¼	connects to 20" both sides	2906	295	
xBCRB0D-4242-0-GL1		42	42	41¼	connects to 24" both sides	2906	295	
xBCRC0D-4242-0-GL1		42	42	41¼	connects to 30" both sides	2906	295	
xBCRD0D-4242-0-GL1		42	42	41¼	connects to 20" on left and 24" on right	2906	295	
xBCRE0D-4242-0-GL1		42	42	41¼	connects to 24" on left and 20" on right	2906	295	
Includes 1 grommet - center	see page 15 for diagonal or radius dimension				unit to ship knockdown with removable worksurface (note: no profile detail available)			

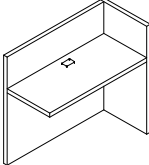
Description	Model Number	Overall Dimensions (in.)			Notes	Price (US\$)	Weight (lbs.)
		Depth	Width	Height			
 Gallery Desk Return Shell	xR0R-2036- R -GL1	20	36	41¼		1675	105
	xR0R-2042- R -GL1	20	42	41¼		1781	117
	xR0R-2048- R -GL1	20	48	41¼		1887	130
	xR0R-2054- R -GL1	20	54	41¼		1993	143
	xR0R-2060- R -GL1	20	60	41¼		2100	156
	xR0R-2436- R -GL1	24	36	41¼		1754	115
	xR0R-2442- R -GL1	24	42	41¼		1864	129
	xR0R-2448- R -GL1	24	48	41¼		1974	143
	xR0R-2454- R -GL1	24	54	41¼		2083	156
	xR0R-2460- R -GL1	24	60	41¼		2189	170
	xR0R-3042- R-0 -GL1	30	42	41¼		1989	146
	xR0R-3048- R-0 -GL1	30	48	41¼		2100	161
	xR0R-3054- R-0 -GL1	30	54	41¼		2212	176
	xR0R-3060- R-0 -GL1	30	60	41¼		2328	191

Includes 1 grommet - center of kneespace

Specify **L** or **R** (seated) (**R** indicated)

(note: no profile detail available)

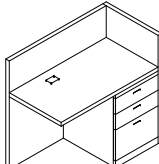
 Gallery Desk Return w/ Single Pedestal	xR0R-2042- AR -GL1	20	42	41¼	letter width b/b/f pedestal	2831	197
	xR0R-2048- CR -GL1	20	48	41¼	legal width b/b/f pedestal	2938	210
	xR0R-2054- CR -GL1	20	54	41¼	legal width b/b/f pedestal	3043	223
	xR0R-2060- CR -GL1	20	60	41¼	legal width b/b/f pedestal	3150	236
	xR0R-2442- AR -GL1	24	42	41¼	letter width b/b/f pedestal	2966	209
	xR0R-2448- CR -GL1	24	48	41¼	legal width b/b/f pedestal	3077	223
	xR0R-2454- CR -GL1	24	54	41¼	legal width b/b/f pedestal	3187	236
	xR0R-2460- CR -GL1	24	60	41¼	legal width b/b/f pedestal	3295	250
	xR0R-3042- AR -GL1	30	42	41¼	letter width b/b/f pedestal	3141	226
	xR0R-3048- CR -GL1	30	48	41¼	legal width b/b/f pedestal	3256	241
	xR0R-3054- CR -GL1	30	54	41¼	legal width b/b/f pedestal	3367	256
	xR0R-3060- CR -GL1	30	60	41¼	legal width b/b/f pedestal	3481	271

Includes 1 grommet - center of kneespace

Specify **L** or **R** (seated) (**R** indicated)

(note: no profile detail available)

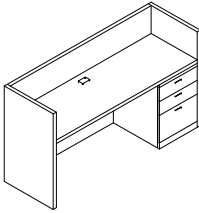
Description	Model Number	Overall Dimensions (in.)			Notes	Price (US\$)	Weight (lbs.)
		Depth	Width	Height			
	xCOR-2466-AR-GL1	24	66	41¼	letter width b/b/f pedestal	3871	297
	xCOR-2472-CR-GL1	24	72	41¼	legal width b/b/f pedestal	3990	311
	xCOR-2478-CR-GL1	24	78	41¼	legal width b/b/f pedestal	4101	324
	xCOR-2484-CR-GL1	24	84	41¼	legal width b/b/f pedestal	4212	338
	xCOR-2490-CR-GL1	24	90	41¼	legal width b/b/f pedestal	4323	351
	xCOR-2496-CR-GL1	24	96	41¼	legal width b/b/f pedestal	4433	365
	xCOR-3066-AR-GL1	30	66	41¼	letter width b/b/f pedestal	4094	328
	xCOR-3072-CR-GL1	30	72	41¼	legal width b/b/f pedestal	4221	343
	xCOR-3078-CR-GL1	30	78	41¼	legal width b/b/f pedestal	4338	358
	xCOR-3084-CR-GL1	30	84	41¼	legal width b/b/f pedestal	4449	373
	xCOR-3090-CR-GL1	30	90	41¼	legal width b/b/f pedestal	4564	387
	xCOR-3096-CR-GL1	30	96	41¼	legal width b/b/f pedestal	4681	402

Includes 1 grommet - center of kneespace

Legal width b/b/f pedestal

Specify Left or **Right** (seated)

(**Right** indicated)

(note: no profile detail available)

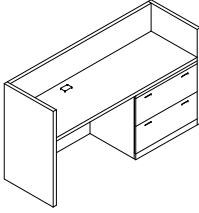
	xCOR-2466-ER-GL1	24	66	41¼		4131	317
	xCOR-2472-ER-GL1	24	72	41¼		4253	331
	xCOR-2478-ER-GL1	24	78	41¼		4364	344
	xCOR-2484-ER-GL1	24	84	41¼		4474	358
	xCOR-2490-ER-GL1	24	90	41¼		4583	371
	xCOR-2496-ER-GL1	24	96	41¼		4692	385
	xCOR-3066-ER-GL1	30	66	41¼		4359	348
	xCOR-3072-ER-GL1	30	72	41¼		4484	363
	xCOR-3078-ER-GL1	30	78	41¼		4600	378
	xCOR-3084-ER-GL1	30	84	41¼		4715	393
	xCOR-3090-ER-GL1	30	90	41¼		4827	407
	xCOR-3096-ER-GL1	30	96	41¼		4943	422

Includes 1 grommet - center of kneespace

Letter width lateral file pedestal

Specify Left or **Right** (seated)

(**Right** indicated)

(note: no profile detail available)

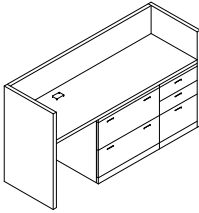
Description	Model Number	Overall Dimensions (in.)			Notes	Price (US\$)	Weight (lbs.)
		Depth	Width	Height			
	xCOR-2472-ECR-GL1	24	72	41¼		5355	411
	xCOR-2478-ECR-GL1	24	78	41¼		5466	424
	xCOR-2484-ECR-GL1	24	84	41¼		5577	438
	xCOR-2490-ECR-GL1	24	90	41¼		5688	451
	xCOR-2496-ECR-GL1	24	96	41¼		5798	465
	xCOR-3072-ECR-GL1	30	72	41¼		5639	443
	xCOR-3078-ECR-GL1	30	78	41¼		5755	458
	xCOR-3084-ECR-GL1	30	84	41¼		5866	473
	xCOR-3090-ECR-GL1	30	90	41¼		5982	487
	xCOR-3096-ECR-GL1	30	96	41¼		6097	502

Includes 1 grommet - center of kneespace

Letter width lateral file pedestal

Legal width b/b/f pedestal

Specify **Left** or **Right** (seated)

(**R**ight indicated)

(note: no profile detail available)

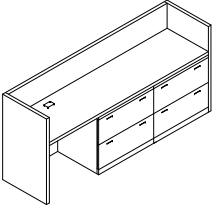
	xCOR-2490-EER-GL1	24	90	41¼		5950	471
	xCOR-2496-EER-GL1	24	96	41¼		6061	485
	xCOR-3090-EER-GL1	30	90	41¼		6244	507
	xCOR-3096-EER-GL1	30	96	41¼		6361	522

Includes 1 grommet - center of kneespace

2 letter width lateral file pedestals

Specify **Left** or **Right** (seated)

(**R**ight indicated)

(note: no profile detail available)

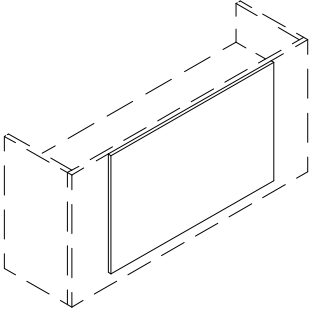
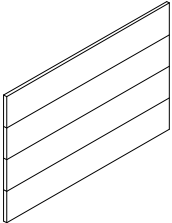
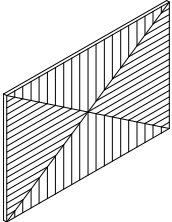
Description	Model Number	Overall Dimensions (in.)			Notes	Price (US\$)	Weight (lbs.)	
		Depth	Width	Height				
Applied Feature Fronts for Gallery Desks								
I		1WFI-158	3/4	58	38	vertical grain cherry or maple	964	46
		1WFI-164	3/4	64	38		996	51
		1WFI-170	3/4	70	38		1032	55
		1WFI-176	3/4	76	38		1070	60
II		1WFII-158	3/4	58	38	vertical grain cherry or maple with black 1/4" x 1/4" horizontal reveals	1347	46
		1WFII-164	3/4	64	38		1405	51
		1WFII-170	3/4	70	38		1461	55
		1WFII-176	3/4	76	38		1518	60
III		1WFIII-158	3/4	58	38	reverse box pattern birdseye maple	2968	46
		1WFIII-164	3/4	64	38		3211	51
		1WFIII-170	3/4	70	38		3453	55
		1WFIII-176	3/4	76	38		3698	60

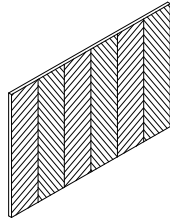
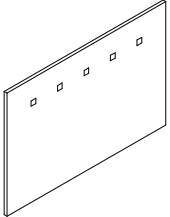
Description	Model Number	Overall Dimensions (in.)			Notes	Price (US\$)	Weight (lbs.)	
		Depth	Width	Height				
IV		1WFIV-158	¾	59	38	quartered figured sycamore or anigre	1866	46
		1WFIV-164	¾	64	38		1994	51
		1WFIV-170	¾	70	38		2121	55
		1WFIV-176	¾	76	38		2252	60
V		1WFV-158	¾	58	38	contrast square inlay options: options: * natural cherry in natural maple * natural maple in natural cherry * black in maple (any CCN standard finish) * black in cherry (any CCN standard finish)	1273	46
		1WFV-164	¾	64	38		1340	51
		1WFV-170	¾	70	38		1407	55
		1WFV-176	¾	76	38		1477	60

58 inch wide Feature Fronts recommended for use on 72 inch wide Gallery Desks
64 inch wide Feature Fronts recommended for use on 78 inch wide Gallery Desks
70 inch wide Feature Fronts recommended for use on 84 inch wide Gallery Desks
76 inch wide Feature Fronts recommended for use on 96 inch wide Gallery Desks

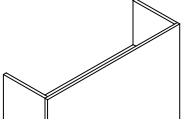
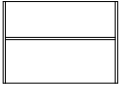
Description	Model Number	Overall Dimensions (in.)			Notes	Price (US\$)	Weight (lbs.)
		Depth	Width	Height			
Workstation Desk Shell  	xD0R-2460-0-GL2	24	60	50½		3001	241
	xD0R-2466-0-GL2	24	66	50½		3127	257
	xD0R-2472-0-GL2	24	72	50½		3262	273
	xD0R-2478-0-GL2	24	78	50½		3387	288
	xD0R-2484-0-GL2	24	84	50½		3511	304
	xD0R-2490-0-GL2	24	90	50½		3636	319
	xD0R-2496-0-GL2	24	96	50½		3761	335

Includes 2 grommets

(note: no profile detail available)

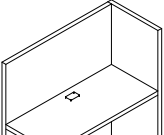
Workstation Return Shell 	xR0R-2436- R -GL1	24	36	50½		1910	136
	xR0R-2442- R -GL1	24	42	50½		2031	152
	xR0R-2448- R -GL1	24	48	50½		2155	168
	xR0R-2454- R -GL1	24	54	50½		2274	183
	xR0R-2460- R -GL1	24	60	50½		2397	199
	xR0R-2466- R -GL1	24	66	50½		2519	214
	xR0R-2472- R -GL1	24	72	50½		2650	230

Includes 1 grommet - center
Specify **Left** or **Right** (seated)

(**Right** indicated)

(note: no profile detail available)

Description	Model Number	Overall Dimensions (in.)			Notes	Price (US\$)	Weight (lbs.)
		Depth	Width	Height			
Workstation Bridge	xB0R-2436-0-GL1	24	36	50½		1379	94
	xB0R-2442-0-GL1	24	42	50½		1495	109
	xB0R-2448-0-GL1	24	48	50½		1618	125
	xB0R-2454-0-GL1	24	54	50½		1736	141

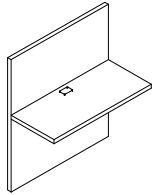

Includes 1 grommet - center

Workstation Corner Bridge	xBCRB-3636-0-GL1	36	36	50½	connects to 24" both sides	2752	295
	xBCRB-4242-0-GL1	42	42	50½	connects to 24" both sides	3148	353

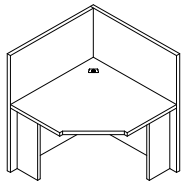

Seated Diagonal

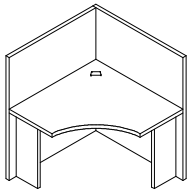

Seated Radius

	xBCRB0D-3636-0-GL1	36	36	50½	connects to 24" both sides	2831	295
	xBCRB0D-4242-0-GL1	42	42	50½	connects to 24" both sides	3227	353

(note: no profile detail available)
(note: worksurface removable for shipping)

Includes 1 grommet - center

Description	Model Number	Overall Dimensions (in.)			Notes	Price (US\$)	Weight (lbs.)
		Depth	Width	Height			
Workstation Return Shell w/ Arc Transition along width	xR0A-2436- R -GL1	24	36	50½		2066	156
	xR0A-2442- R -GL1	24	42	50½		2186	172
	xR0A-2448- R -GL1	24	48	50½		2309	188
	xR0A-2454- R -GL1	24	54	50½		2429	203
	xR0A-2460- R -GL1	24	60	50½		2549	219
	xR0A-2466- R -GL1	24	66	50½		2671	234
	xR0A-2472- R -GL1	24	72	50½		2801	250

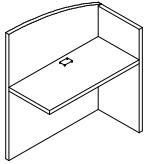

Includes 1 grommet - center
Specify **Left** or **Right** (seated)

(**Right** indicated)

(note: no profile detail available)
50½" high at high end, 41¼" high at low end

Workstation Bridge w/ Arc Transition	xB0A-2436- R -GL1	24	36	50½		1560	94
	xB0A-2442- R -GL1	24	42	50½		1680	109
	xB0A-2448- R -GL1	24	48	50½		1803	125
	xB0A-2454- R -GL1	24	54	50½		1923	141

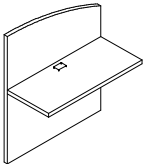

Includes 1 grommet - center
Specify **Left** or **Right** (seated)

(**Right** indicated)

(note: no profile detail available)
50½" high at high end, 41¼" high at low end

Description	Model Number	Overall Dimensions (in.)			Notes	Price (US\$)	Weight (lbs.)
		Depth	Width	Height			
Workstation Corner Bridge w/ Arc Transition	xBCAB0D-4242- R -GL1	42	42	50½		3400	353

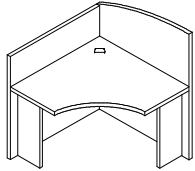

Includes 1 grommet
Specify **Left** or **Right** (seated)

(**R**ight indicated)

(note: no profile detail available)
(note: worksurface removable for shipping)
50½" high at high end, 41¼" high at low end

Gallery Return Shell w/
Arc Transition at end

xRAR-2436- R -GL1	24	36	41¼
xRAR-2442- R -GL1	24	42	41¼
xRAR-2448- R -GL1	24	48	41¼
xRAR-2454- R -GL1	24	54	41¼
xRAR-2460- R -GL1	24	60	41¼
xRAR-2466- R -GL1	24	66	41¼
xRAR-2472- R -GL1	24	72	41¼

1927	115
2037	129
2147	143
2256	156
2363	170
2473	183
2596	197

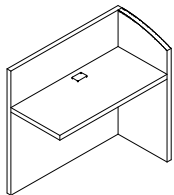

Includes 1 grommet - center
Specify **Left** or **Right** (seated)

(**R**ight indicated)

(note: no profile detail available)
41¼" high at high end, 37¾" high at low end

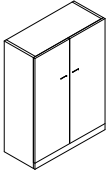
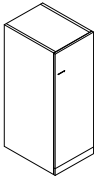
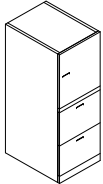
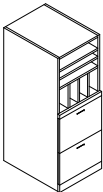
Description	Model Number	Overall Dimensions (in.)			Notes	Price (US\$)	Weight (lbs.)
		Depth	Width	Height			
Hinged Door Storage 	xSH013-2530	25	30 $\frac{1}{8}$	50 $\frac{1}{2}$		2839	221
	xSH013-2536	25	36 $\frac{1}{8}$	50 $\frac{1}{2}$		3068	255
3 adjustable shelves							
Hinged Door Storage 	xSH013-2516- R	25	16	50 $\frac{1}{2}$		2309	143
	xSH013-2519- R	25	19	50 $\frac{1}{2}$		2423	159
3 adjustable shelves	Specify Left or Right (right shown)						
Combination File/Storage 	xSS0112-2516- R	25	16	50 $\frac{1}{2}$	storage above, 2 letter width files below	3106	173
	xSS0112-2519- R	25	19	50 $\frac{1}{2}$	storage above, 2 legal width files below	3214	190
	xSS0112-2530- R	25	30	50 $\frac{1}{2}$	storage above, 2- 30" w lateral files below	3613	252
	xSS0112-2536- R	25	36	50 $\frac{1}{2}$	storage above, 2- 36" w lateral files below	3834	285
1 adjustable shelf above	Specify Left or Right (right shown)						
Combination File/Sorter 	xSY01D2-2516	25	16	50 $\frac{1}{2}$	2 letter width files below	3287	196
	xSY01D2-2519	25	19	50 $\frac{1}{2}$	2 legal width files below	3409	214
2 drawers below vertical/horizontal divider above					(note: all units on this page have finished backs and tops)		

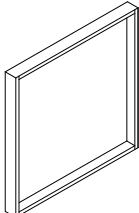
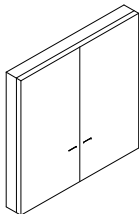
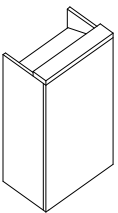
Description	Model Number	Overall Dimensions (in.)			Notes	Price (US\$)	Weight (lbs.)
		Depth	Width	Height			
Presentation Board 	xVBN-3648	4½	36	48	square edge (no profile detail)	1296	54
	xVBN-4848	4½	48	48	square edge (no profile detail)	1412	72
	xVBN-6048	4½	60	48	square edge (no profile detail)	1668	90
Dry Erase writing surface interior							
Hinged Door presentation Board 	xVBH-3648	6	36	48	square edge (no profile detail)	1920	108
	xVBH-4848	6	48	48	square edge (no profile detail)	2151	144
	xVBH-6048	6	60	48	square edge (no profile detail)	2524	180
	_WC11-7362	6⅞	36	1½	top cap with edge profile	???	9
	_WC11-7482	6⅞	48⅞	1½	top cap with edge profile	???	12
	_WC11-7602	6⅞	60⅞	1½	top cap with edge profile	371	15
Fabric panels inside of doors Dry Erase writing surface interior							
Podium 	_VP-2030	20	30	42¾		1682	119
	_VP-2036	20	36	42¾		1875	131
Fixed shelf in kneespace							

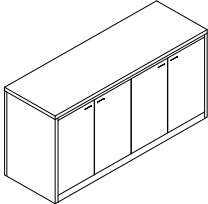
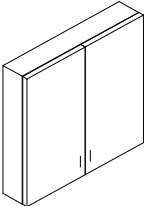
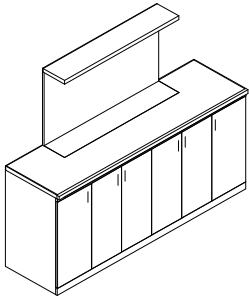
Description	Model Number	Overall Dimensions (in.)			Notes	Price (US\$)	Weight (lbs.)
		Depth	Width	Height			
	_C0V0L-2072-HHHH	20	72	36	2 bay, 4 hinged doors	3479	223
	_C0V0L-2072-HHHHHH	20	84	36	3 bay, 6 hinged doors	4384	260
	_C0V0L-2072-HHHHHH	20	96	36	3 bay, 6 hinged doors	4559	277
	_C0V0L-2072-HHHH	24	72	36	2 bay, 4 hinged doors	3648	233
	_C0V0L-2072-HHHHHH	24	84	36	3 bay, 6 hinged doors	4614	271
	_C0V0L-2072-HHHHHH	24	96	36	3 bay, 6 hinged doors	4795	290
	_VDH-4839	10	48	39	square edge (no profile detail)	1977	117
	_VDH-5439	10	54	39	square edge (no profile detail)	2090	132
	_VDH-6039	10	60	39	square edge (no profile detail)	2339	146
	_VDH-6639	10	66	39	square edge (no profile detail)	2314	161
	_WC11-11482	10 ⁷ / ₈	48	1 ¹ / ₂	top cap with edge profile		18
	_WC11-11542	10 ⁷ / ₈	54	1 ¹ / ₂	top cap with edge profile	367	21
	_WC11-11602	10 ⁷ / ₈	60	1 ¹ / ₂	top cap with edge profile	389	23
	_WC11-11662	10 ⁷ / ₈	66	1 ¹ / ₂	top cap with edge profile	412	25
Fabric panels inside of doors							
	_C0Y-2884	28	84	40	accommodates 42" plasma display	12635	483
	_C0Y-2896	28	96	40	accommodates 54" plasma display	14032	520
					2 full depth outside hinged door compartments 15" deep equipment shelves behind center doors with wire access to plasma display.		
Plasma lift remote control included							

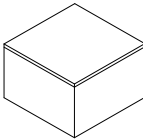
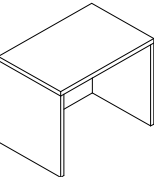
Description	Model Number	Overall Dimensions (in.)			Notes	Price (US\$)	Weight (lbs.)
		Depth	Width	Height			
Occasional Drum Table 	_TD-2020	19 $\frac{5}{8}$	19 $\frac{5}{8}$	18		865	81
	_TD-2626	25 $\frac{5}{8}$	25 $\frac{5}{8}$	20		1199	108
	_TD-2929	29 $\frac{1}{8}$	29 $\frac{1}{8}$	20		1801	124
	_TD-2929	29 $\frac{1}{8}$	29 $\frac{1}{8}$	16		1643	116
Occasional Cube Table 	_TC-2626	26	26	20		1084	104
	_TC-2130	21	30	20		1071	99
	_TC-3030	30	30	20		1210	131
	_TC-4040	40	40	16		1506	198
Task Table 	xM0-2430	24	30	29 $\frac{1}{4}$		1716	113
	xM0-2436	24	36	29 $\frac{1}{4}$		1803	121
	xM0-2442	24	42	29 $\frac{1}{4}$		1887	130
	xMM-2430	24	30	29 $\frac{1}{4}$		1883	113
	xMM-2436	24	36	29 $\frac{1}{4}$		1969	121
	xMM-2442	24	42	29 $\frac{1}{4}$		2056	130

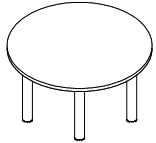
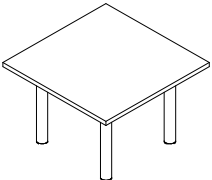
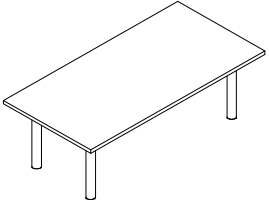
Description	Model Number	Overall Dimensions (in.)			Notes	Price (US\$)	Weight (lbs.)
		Depth	Width	Height			
	Round Table Desk w/ Legs	_TR4I-3636	36	36	29¼	2637	85
		_TR4I-4242	42	42	29¼	2964	101
		_TR4I-4848	48	48	29¼	3501	120
		_TR4I-5454	54	54	29¼	3904	141
		_TR4I-6060	60	60	29¼	4329	165
4- 4" legs Specify chrome or black legs							
	Square Table w/ Legs	_TS4I-3636	36	36	29¼	1861	85
		_TS4I-4242	42	42	29¼	2062	101
		_TS4I-4848	48	48	29¼	2469	120
		_TS4I-5454	54	54	29¼	2739	141
		_TS4I-6060	60	60	29¼	3036	165
4- 4" legs Specify chrome or black legs							
	Rectangular Table w/ Legs	_TS4I-3060	30	60	29¼	2313	103
		_TS4I-3066	30	66	29¼	2421	109
		_TS4I-3072	30	72	29¼	2529	115
		_TS4I-3666	36	66	29¼	2573	123
		_TS4I-3672	36	72	29¼	2689	130
		_TS4I-3678	36	78	29¼	3094	138
		_TS4I-3684	36	84	29¼	3217	145
		_TS4I-4284	42	84	29¼	3402	163
		_TS4I-4290	42	90	29¼	3536	171
4- 4" legs Specify chrome or black legs							

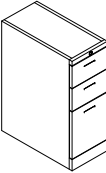
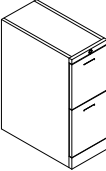
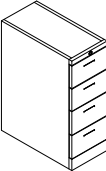
Description	Model Number	Overall Dimensions (in.)			Notes	Price (US\$)	Weight (lbs.)	
		Depth	Width	Height				
Mini Pedestal -2 box, 1 file drawers	xPa03-209	18 ³ / ₈	9 ³ / ₈	27 ³ / ₄		998	80	
	xPa03-249	22 ³ / ₈	9 ³ / ₈	27 ³ / ₄		1050	80	
	xPa03-309	28 ³ / ₄	9 ³ / ₈	27 ³ / ₄		1103	80	
								
Includes lock Side to side filing only		top and back painted black						
Mini Pedestal -2 file drawers	xPb03-209	18 ³ / ₈	9 ³ / ₈	27 ³ / ₄		998	80	
	xPb03-249	22 ³ / ₈	9 ³ / ₈	27 ³ / ₄		1050	80	
	xPb03-309	28 ³ / ₄	9 ³ / ₈	27 ³ / ₄		1103	80	
								
Includes lock Side to side filing only		top and back painted black						
Mini Pedestal -4 box drawers	xPe03-209	18 ³ / ₈	9 ³ / ₈	27 ³ / ₄		1050	80	
	xPe03-249	22 ³ / ₈	9 ³ / ₈	27 ³ / ₄		1103	80	
	xPe03-309	28 ³ / ₄	9 ³ / ₈	27 ³ / ₄		1155	80	
								
Includes lock		top and back painted black						

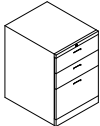
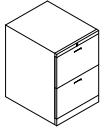
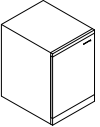
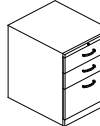
Description	Model Number	Overall Dimensions (in.)			Notes	Price (US\$)	Weight (lbs.)	
		Depth	Width	Height				
	Pedestal - 2 box, 1 file drawers	xPA03-2016	18 ³ / ₈	15 ³ / ₄	27 ³ / ₄	1050	80	
		xPA03-2416	22 ³ / ₈	15 ³ / ₄	27 ³ / ₄	1103	80	
		xPA03-3016	27 ⁵ / ₈	15 ³ / ₄	27 ³ / ₄	1155	80	
		xPC03-2019	18 ³ / ₈	18 ³ / ₄	27 ³ / ₄	1050	80	
		xPC03-2419	22 ³ / ₈	18 ³ / ₄	27 ³ / ₄	1103	80	
		xPC03-3019	27 ⁵ / ₈	18 ³ / ₄	27 ³ / ₄	1155	80	
		xPC03-3619	33 ⁵ / ₈	18 ³ / ₄	27 ³ / ₄	1208	80	
	Includes lock					top and back painted black		
	Pedestal - 2 file drawers	xPB03-2016	18 ³ / ₈	15 ³ / ₄	27 ³ / ₄	1050	80	
		xPB03-2416	22 ³ / ₈	15 ³ / ₄	27 ³ / ₄	1103	80	
		xPB03-3016	27 ⁵ / ₈	15 ³ / ₄	27 ³ / ₄	1155	80	
		xPD03-2019	18 ³ / ₈	18 ³ / ₄	27 ³ / ₄	1050	80	
		xPD03-2419	22 ³ / ₈	18 ³ / ₄	27 ³ / ₄	1103	80	
		xPD03-3019	27 ⁵ / ₈	18 ³ / ₄	27 ³ / ₄	1155	80	
		xPD03-3619	33 ⁵ / ₈	18 ³ / ₄	27 ³ / ₄	1208	80	
	Includes lock					top and back painted black		
	Pedestal - hinged door	xPH03-2016-L	18 ³ / ₈	15 ³ / ₄	27 ³ / ₄	735	35	
		xPH03-2416-L	22 ³ / ₈	15 ³ / ₄	27 ³ / ₄	788	35	
		xPH03-3016-L	27 ⁵ / ₈	15 ³ / ₄	27 ³ / ₄	840	35	
		xPH03-2019-L	18 ³ / ₈	18 ³ / ₄	27 ³ / ₄	735	35	
		xPH03-2419-L	22 ³ / ₈	18 ³ / ₄	27 ³ / ₄	788	35	
		xPH03-3019-L	27 ⁵ / ₈	18 ³ / ₄	27 ³ / ₄	840	35	
	Specify Left or Right hinged door	(Left shown)				top and back painted black		
	Mobile Pedestal-2 box,1 file Drawer	xPA05C-2016	18 ³ / ₈	15 ³ / ₄	27 ¹ / ₂	1050	80	
		xPA05C-2416	22 ³ / ₈	15 ³ / ₄	27 ¹ / ₂	1103	80	
		xPC03C-2019	18 ³ / ₈	18 ³ / ₄	27 ¹ / ₂	1050	80	
		xPC03C-2419	22 ³ / ₈	18 ³ / ₄	27 ¹ / ₂	1103	80	
	Unit is on castors with 5th wheel to stabilize file drawer					Finished 4 sides and top		

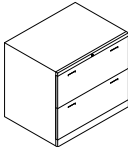
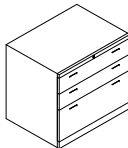
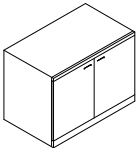
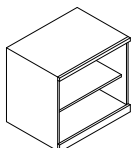
Description	Model Number	Overall Dimensions (in.)			Notes	Price (US\$)	Weight (lbs.)
		Depth	Width	Height			
	xPE03-2030	18 ³ / ₈	30	27 ³ / ₄		1313	100
	xPE03-2430	22 ³ / ₈	30	27 ³ / ₄		1365	100
	xPE03-3030	27 ⁵ / ₈	30	27 ³ / ₄		1418	100
	xPF03-2036	18 ³ / ₈	36	27 ³ / ₄		1313	100
	xPF03-2436	22 ³ / ₈	36	27 ³ / ₄		1365	100
	xPF03-3036	27 ⁵ / ₈	36	27 ³ / ₄		1418	100
Includes lock					top and back painted black		
	xPT03-2030	18 ³ / ₈	30	27 ³ / ₄		1418	100
	xPT03-2430	22 ³ / ₈	30	27 ³ / ₄		1470	100
	xPT03-3030	27 ⁵ / ₈	30	27 ³ / ₄		1523	100
	xPU03-2036	18 ³ / ₈	36	27 ³ / ₄		1418	100
	xPU03-2436	22 ³ / ₈	36	27 ³ / ₄		1470	100
	xPU03-3036	27 ⁵ / ₈	36	27 ³ / ₄		1523	100
Includes lock					top and back painted black		
	xPHH3-2030	18 ³ / ₈	30	27 ³ / ₄		1050	60
	xPHH3-2430	22 ³ / ₈	30	27 ³ / ₄		1103	60
	xPHH03-3030	27 ⁵ / ₈	30	27 ³ / ₄		1155	60
	xPHH3-2036	18 ³ / ₈	36	27 ³ / ₄		1050	60
	xPHH3-2436	22 ³ / ₈	36	27 ³ / ₄		1103	60
	xPHH3-3036	27 ⁵ / ₈	36	27 ³ / ₄		1155	60
One adjustable shelf					top and back painted black		
	xPMM3-2030	18 ³ / ₄	30	27 ³ / ₄		840	50
	xPMM3-2030	22 ³ / ₈	30	27 ³ / ₄		893	50
	xPMM3-2030	27 ⁵ / ₈	30	27 ³ / ₄		945	50
	xPNN3-2036	18 ³ / ₈	36	27 ³ / ₄		840	50
	xPNN3-2036	22 ³ / ₈	36	27 ³ / ₄		893	50
	xPNN3-2036	27 ⁵ / ₈	36	27 ³ / ₄		945	50
One adjustable shelf					top and back painted black		

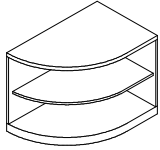
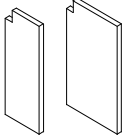
Description	Model Number	Overall Dimensions (in.)			Notes	Price (US\$)	Weight (lbs.)
		Depth	Width	Height			
	xSEI110L-1919	19¼	19¼	27¾		1105	50
	xSEI110L-1923	19¼	23¼	27¾		1176	56
	xSEI110L-1929	19¼	29¼	27¾		1285	64
	xSEI110L-1935	19¼	35¼	27¾		1395	73
	xSEI110L-1941	19¼	41¼	27¾		1506	82
	xSEI110L-2323	23¼	23¼	27¾		1279	67
	xSEI110L-2329	23¼	29¼	27¾		1394	78
	xSEI110L-2335	23¼	35¼	27¾		1513	88
	xSEI110L-2929	29¼	29¼	27¾		1559	98
	One fixed height shelf Specify Left or Right	(L eft indicated)				top and back painted black	
Bracing Leg	xWL2N0S-10	10	1¼	27¾		357	10
	xWL2N0S-15	15	1¼	27¾		374	15
	xWL2N0A-9	9	1¼	27¾		469	9
	xWL2N0A-12	12	1¼	27¾		481	12
	xWL2N0A-15	15	1¼	27¾		489	15
	xWL2N0A-18	18	1¼	27¾		501	18
	xWL2N0A-21	21	1¼	27¾		512	20
	xWL2N0A-24	24	1¼	27¾		523	23
	xWL2N0A-27	27	1¼	27¾		532	26
	xWL2N0A-30	30	1¼	27¾		543	29

Description	Model Number	Overall Dimensions (in.)			Notes	Price (US\$)	Weight (lbs.)
		Depth	Width	Height			
"L" End Panel	xWE2-1810-R	18 ³ / ₈	10	27 ³ / ₄		401	31
	xWE2-2210-R	22 ³ / ₈	10	27 ³ / ₄		418	35
	xWE2-2810-R	27 ⁵ / ₈	10	27 ³ / ₄		444	41
	xWE2-3410-R	33 ⁵ / ₈	10	27 ³ / ₄		469	47

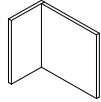

Specify **Left** or **Right** (Right indicated)

Workstation "L" End Panel w/ Arc Front	xWE20A-2517-R	25 ¹ / ₄	17	70 ¹ / ₂		910	96
--	---------------	--------------------------------	----	--------------------------------	--	-----	----

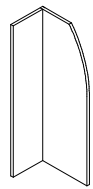

Specify **Left** or **Right** (Right indicated)

Workstation "L" End Panel	xWE2-2117-R	21 ¹ / ₄	17	70 ¹ / ₂		752	86
	xWE2-2517-R	25 ¹ / ₄	17	70 ¹ / ₂		795	96

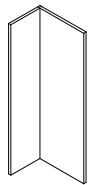

Specify **Left** or **Right** (Right indicated)

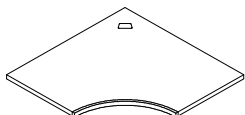
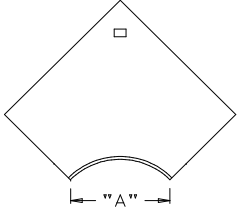
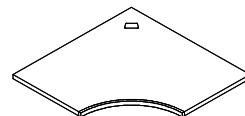
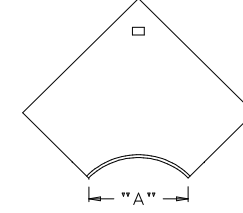
Description	Model Number	Overall Dimensions (in.)			Notes	Price (US\$)	Weight (lbs.)	
		Depth	Width	Height				
Corner Worksurface  	_BC0AT-3636-0-GL1	36	36	29¼	"A" = 22 ⁵ / ₈ " connects to 20" each side	1005	45	
	_BC0BT-3636-0-GL1	36	36	29¼	"A" = 16 ⁷ / ₈ " connects to 24" each side	1005	45	
	_BC0BT-4242-0-GL1	42	42	29¼	"A" = 31 ¹ / ₈ " connects to 20" each side	1140	61	
	_BC0BT-4242-0-GL1	42	42	29¼	"A" = 25 ¹ / ₂ " connects to 24" each side	1140	61	
	_BC0BT-3636-0-GL1	36	36	29¼	"A" = 20" connects to 20" on left and 24" on right	1005	45	
	_BC0BT-3636-0-GL1	36	36	29¼	"A" = 20" connects to 24" on left and 20" on right	1005	45	
	_BC0BT-4242-0-GL1	42	42	29¼	"A" = 28 ¹ / ₈ " connects to 20" on left and 24" on right	1140	61	
	_BC0BT-4242-0-GL1	42	42	29¼	"A" = 28 ⁵ / ₈ " connects to 24" on left and 20" on right	1140	61	
	Includes 1 grommet							
	Cove Corner Worksurface  	_BC0ATD-3636-0-GL1	36	36	29¼	"A" = 22 ⁵ / ₈ " connects to 20" each side	1084	45
_BC0BTD-3636-0-GL1		36	36	29¼	"A" = 16 ⁷ / ₈ " connects to 24" each side	1084	45	
_BC0ATD-4242-0-GL1		42	42	29¼	"A" = 31 ¹ / ₈ " connects to 20" each side	1219	61	
_BC0BTD-4242-0-GL1		42	42	29¼	"A" = 25 ¹ / ₂ " connects to 24" each side	1219	61	
_BC0DTD-3636-0-GL1		36	36	29¼	"A" = 20" connects to 20" on left and 24" on right	1084	45	
_BC0ETD-3636-0-GL1		36	36	29¼	"A" = 20" connects to 24" on left and 20" on right	1084	45	
_BC0DTD-4242-0-GL1		42	42	29¼	"A" = 28 ¹ / ₈ " connects to 20" on left and 24" on right	1219	61	
_BC0ETD-4242-0-GL1		42	42	29¼	"A" = 28 ³ / ₈ " connects to 24" on left and 20" on right	1219	61	
Includes 1 grommet								

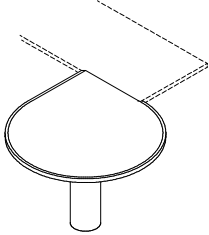
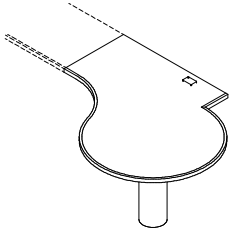
Description	Model Number	Overall Dimensions (in.)			Notes	Price (US\$)	Weight (lbs.)
		Depth	Width	Height			
	_DQUI-3636- R	36	36	29¼	4" post leg, attaches to 18" or longer worksurface	1597	55
	_DQUH-4242- R	42	42	29¼	6" post leg, attaches to 21" or longer worksurface	1915	76
	_DQUH-4848- R	48	48	29¼	6" post leg, attaches to 24" or longer worksurface	2075	95
Connects to end of worksurface, desk, or credenza via counter profile Specify chrome or black leg Specify Left or Right (seated)		(Right indicated)			Note: no grommet		
	_DEUI-5145- R -GL1	51	45	29¼	36" diam. conference surface, 4" post leg	2265	90
	_DEUI-5148- R -GL1	51	48	29¼	36" diam. conference surface, 4" post leg	2310	95
	_DEUI-5163- R -GL1	51	63	29¼	36" diam. conference surface, 4" post leg	2541	122
	_DEUI-5166- R -GL1	51	66	29¼	36" diam. conference surface, 4" post leg	2588	127
	_DEUI-5172- R -GL1	51	72	29¼	36" diam. conference surface, 4" post leg	2703	138
	_DEUI-5175- R -GL1	51	75	29¼	36" diam. conference surface, 4" post leg	2748	143
	_DEUI-5184- R -GL1	51	84	29¼	36" diam. conference surface, 4" post leg	2888	159
	_DEUI-5187- R -GL1	51	87	29¼	36" diam. conference surface, 4" post leg	2938	164
	_DEUH-5754- R -GL1	57	54	29¼	42" diam. conference surface, 6" post leg	2676	122
	_DEUH-5757- R -GL1	57	57	29¼	42" diam. conference surface, 6" post leg	2725	128
	_DEUH-5772- R -GL1	57	72	29¼	42" diam. conference surface, 6" post leg	2988	158
	_DEUH-5775- R -GL1	57	75	29¼	42" diam. conference surface, 6" post leg	3039	163
	_DEUH-5781- R -GL1	57	81	29¼	42" diam. conference surface, 6" post leg	3136	175
_DEUH-5784- R -GL1	57	84	29¼	42" diam. conference surface, 6" post leg	3187	181	
_DEUH-5790- R -GL1	57	90	29¼	42" diam. conference surface, 6" post leg	3285	193	
_DEUH-5793- R -GL1	57	93	29¼	42" diam. conference surface, 6" post leg	3335	199	
Connects to 24" deep straight, flow or cove worksurface Includes 1 grommet Specify chrome or black leg Specify Left or Right (seated)		(Right indicated)					

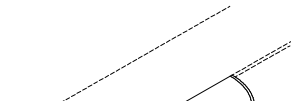
Description	Model Number	Overall Dimensions (in.)			Notes	Price (US\$)	Weight (lbs.)
		Depth	Width	Height			
	_WT11LA-1530	15	30	29¼		1279	31
	_WT11LA-1836	18	36	29¼		1422	41
	_WT11LA-2142	21	42	29¼		1568	52
	_WT11LA-2448	24	48	29¼		1719	64
	_WT11LA-3060	30	60	29¼		2034	93

Counter profiled straight edge
Connects to profiled straight edges

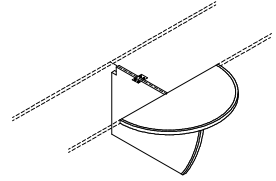
	_WT11LB-4236	42	36	29¼		2190	113
	_WT11LB-4542	45	42	29¼		2354	129
	_WT11LB-4848	48	48	29¼		2522	146
	_WT11LB-5460	54	60	29¼		2868	185

Counter profiled straight edge
Connects to 24" or deeper straight
Worksurfaces

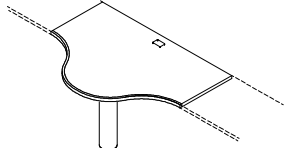
	_WT11CI-4360-0-GL1	42½	60	29¼	4" post leg	1847	100
	_WT11CI-4772-0-GL1	47¼	72	29¼	4" post leg	2139	128

Connects to 24" deep worksurface at each side
Includes 1 grommet - center
Specify chrome or black leg

note: requires Perimeter Wall Mount Kit
(see page 100)

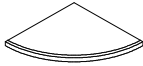
Description	Model Number	Overall Dimensions (in.)			Notes	Price (US\$)	Weight (lbs.)
		Depth	Width	Height			
Bend Worksurface 	_WT11A-2020-L	20	20	1½		613	14
	_WT11A-2024-L	20	24	1½		668	17
	_WT11A-2030-L	20	30	1½		744	21
	_WT11A-2036-L	20	36	1½		820	25
	_WT11A-2042-L	20	42	1½		902	29
	_WT11A-2424-L	24	24	1½		708	20
	_WT11A-2430-L	24	30	1½		792	25
	_WT11A-2436-L	24	36	1½		870	30
	_WT11A-3030-L	30	30	1½		860	31

No grommet
Specify Left or Right

(Left indicated)

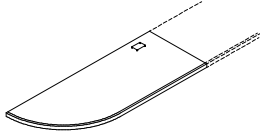
Bend Worksurface 	_WT11A-2048-L-GL1	20	48	1½		1017	33
	_WT11A-2054-L-GL1	20	54	1½		1043	38
	_WT11A-2060-L-GL1	20	60	1½		1124	42
	_WT11A-2066-L-GL1	20	66	1½		1200	46
	_WT11A-2072-L-GL1	20	72	1½		1278	50
	_WT11A-2442-L-GL1	24	42	1½		1365	35
	_WT11A-2448-L-GL1	24	48	1½		1098	40
	_WT11A-2454-L-GL1	24	54	1½		1178	45
	_WT11A-2460-L-GL1	24	60	1½		1261	50
	_WT11A-2466-L-GL1	24	66	1½		1341	55
	_WT11A-2472-L-GL1	24	72	1½		1431	60
	_WT11A-3036-L-GL1	30	36	1½		1011	38
	_WT11A-3042-L-GL1	30	42	1½		1093	44
	_WT11A-3048-L-GL1	30	48	1½		1177	50
	_WT11A-3054-L-GL1	30	54	1½		1263	56
	_WT11A-3060-L-GL1	30	60	1½		1349	63
	_WT11A-3066-L-GL1	30	66	1½		1434	69
	_WT11A-3072-L-GL1	30	72	1½		1532	75

Includes 1 grommet - square end

(Left indicated)

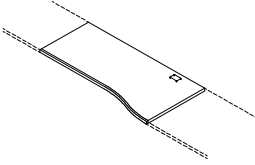
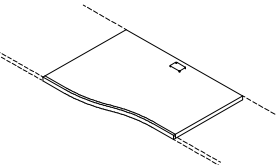
Description	Model Number	Overall Dimensions (in.)			Notes	Price (US\$)	Weight (lbs.)	
		Depth	Width	Height				
Flow Worksurface - W 	_WT11W-2430- R -GL1	24/20	30	1½		828	25	
	_WT11W-2436- R -GL1	24/20	36	1½		910	30	
	_WT11W-2442- R -GL1	24/20	42	1½		989	35	
	_WT11W-2448- R -GL1	24/20	48	1½		1071	40	
	_WT11W-2454- R -GL1	24/20	54	1½		1154	45	
	_WT11W-2460- R -GL1	24/20	60	1½		1234	50	
	_WT11W-2466- R -GL1	24/20	66	1½		1316	55	
	_WT11W-2472- R -GL1	24/20	72	1½		1405	60	
	_WT11W-2478- R -GL1	24/20	78	1½		1488	65	
	_WT11W-3030- R -GL1	30/24	30	1½		890	31	
	_WT11W-3036- R -GL1	30/24	36	1½		975	38	
	_WT11W-3042- R -GL1	30/24	42	1½		1062	44	
	_WT11W-3048- R -GL1	30/24	48	1½		1147	50	
	_WT11W-3054- R -GL1	30/24	54	1½		1232	56	
	_WT11W-3060- R -GL1	30/24	60	1½		1316	63	
	_WT11W-3066- R -GL1	30/24	66	1½		1401	69	
	Transition at wide end	_WT11W-3072- R -GL1	30/24	72	1½		1500	75
	Includes 1 grommet	_WT11W-3078- R -GL1	30/24	78	1½		1586	81
	Specify Left or Right (seated)	(Right indicated)						
	Flow Worksurface - M 	_WT11M-2430- L -GL1	24/20	30	1½		828	25
		_WT11M-2436- L -GL1	24/20	36	1½		910	30
		_WT11M-2442- L -GL1	24/20	42	1½		989	35
		_WT11M-2448- L -GL1	24/20	48	1½		1071	40
		_WT11M-2454- L -GL1	24/20	54	1½		1154	45
		_WT11M-2460- L -GL1	24/20	60	1½		1234	50
		_WT11M-2466- L -GL1	24/20	66	1½		1316	55
		_WT11M-2472- L -GL1	24/20	72	1½		1405	60
		_WT11M-2478- L -GL1	24/20	78	1½		1488	65
_WT11M-3030- L -GL1		30/24	30	1½		890	31	
_WT11M-3036- L -GL1		30/24	36	1½		975	38	
_WT11M-3042- L -GL1		30/24	42	1½		1062	44	
_WT11M-3048- L -GL1		30/24	48	1½		1147	50	
_WT11M-3054- L -GL1		30/24	54	1½		1232	56	
_WT11M-3060- L -GL1		30/24	60	1½		1316	63	
_WT11M-3066- L -GL1		30/24	66	1½		1401	69	
Transition at midspan		_WT11M-3072- L -GL1	30/24	72	1½		1500	75
Includes 1 grommet		_WT11M-3078- L -GL1	30/24	78	1½		1586	81
Specify Left or Right (seated)		(Left indicated)						

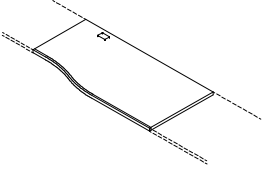
Description	Model Number	Overall Dimensions (in.)			Notes	Price (US\$)	Weight (lbs.)	
		Depth	Width	Height				
Flow Worksurface - N 	_WT11N-2430-L-GL1	24/20	30	1½		828	25	
	_WT11N-2436-L-GL1	24/20	36	1½		910	30	
	_WT11N-2442-L-GL1	24/20	42	1½		989	35	
	_WT11N-2448-L-GL1	24/20	48	1½		1071	40	
	_WT11N-2454-L-GL1	24/20	54	1½		1154	45	
	_WT11N-2460-L-GL1	24/20	60	1½		1234	50	
	_WT11N-2466-L-GL1	24/20	66	1½		1316	55	
	_WT11N-2472-L-GL1	24/20	72	1½		1405	60	
	_WT11N-2478-L-GL1	24/20	78	1½		1488	65	
	_WT11N-3030-L-GL1	30/24	30	1½		890	31	
	_WT11N-3036-L-GL1	30/24	36	1½		975	38	
	_WT11N-3042-L-GL1	30/24	42	1½		1062	44	
	_WT11N-3048-L-GL1	30/24	48	1½		1147	50	
	_WT11N-3054-L-GL1	30/24	54	1½		1232	56	
	_WT11N-3060-L-GL1	30/24	60	1½		1316	63	
	_WT11N-3066-L-GL1	30/24	66	1½		1401	69	
	_WT11N-3072-L-GL1	30/24	72	1½		1500	75	
	_WT11N-3078-L-GL1	30/24	78	1½		1586	81	
	Transition at narrow end							
	Includes 1 grommet							
	Specify Left or Right	(Left indicated)						

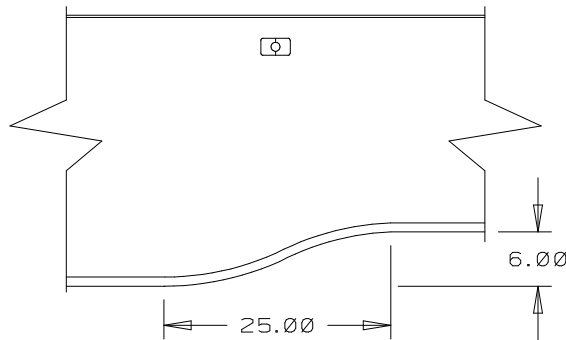

note: on all Flow worksurfaces, grommet location is directly opposite midpoint of transition

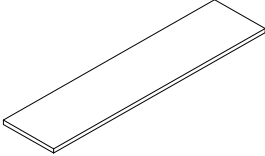
Description	Model Number	Overall Dimensions (in.)			Notes	Price (US\$)	Weight (lbs.)
		Depth	Width	Height			
Worksurface 	_WT11S-2016	20	16 $\frac{1}{8}$	1 $\frac{1}{2}$		431	11
	_WT11S-2019	20	19 $\frac{1}{8}$	1 $\frac{1}{2}$		456	13
	_WT11S-2030	20	30 $\frac{1}{8}$	1 $\frac{1}{2}$		548	21
	_WT11S-2036	20	36 $\frac{1}{8}$	1 $\frac{1}{2}$		599	25
	_WT11S-2042	20	42	1 $\frac{1}{2}$		649	29
	_WT11S-2048	20	48	1 $\frac{1}{2}$		698	33
	_WT11S-2054	20	54	1 $\frac{1}{2}$		749	38
	_WT11S-2060	20	60	1 $\frac{1}{2}$		798	42
	_WT11S-2066	20	66	1 $\frac{1}{2}$		848	46
	_WT11S-2072	20	72	1 $\frac{1}{2}$		907	50
	_WT11S-2078	20	78	1 $\frac{1}{2}$		960	54
	_WT11S-2084	20	84	1 $\frac{1}{2}$		1010	58
	_WT11S-2090	20	90	1 $\frac{1}{2}$		1059	63
	_WT11S-2096	20	96	1 $\frac{1}{2}$		1110	67
	_WT11S-20108	20	108	1 $\frac{1}{2}$		1216	75
	_WT11S-20120	20	120	1 $\frac{1}{2}$		1316	83
	_WT11S-20132	20	132	1 $\frac{1}{2}$		1416	92
	_WT11S-20144	20	144	1 $\frac{1}{2}$		1517	100
	_WT11S-2416	24	16 $\frac{1}{8}$	1 $\frac{1}{2}$		465	13
	_WT11S-2419	24	19 $\frac{1}{8}$	1 $\frac{1}{2}$		494	16
	_WT11S-2430	24	30 $\frac{1}{8}$	1 $\frac{1}{2}$		588	25
	_WT11S-2436	24	36 $\frac{1}{8}$	1 $\frac{1}{2}$		643	30
	_WT11S-2442	24	42	1 $\frac{1}{2}$		694	35
	_WT11S-2448	24	48	1 $\frac{1}{2}$		750	40
	_WT11S-2454	24	54	1 $\frac{1}{2}$		800	45
	_WT11S-2460	24	60	1 $\frac{1}{2}$		853	50
	_WT11S-2466	24	66	1 $\frac{1}{2}$		906	55
	_WT11S-2472	24	72	1 $\frac{1}{2}$		970	60
	_WT11S-2478	24	78	1 $\frac{1}{2}$		1026	65
	_WT11S-2484	24	84	1 $\frac{1}{2}$		1076	70
	_WT11S-2490	24	90	1 $\frac{1}{2}$		1132	75
	_WT11S-2496	24	96	1 $\frac{1}{2}$		1185	80
	_WT11S-24108	24	108	1 $\frac{1}{2}$		1293	90
	_WT11S-24120	24	120	1 $\frac{1}{2}$		1402	100
	_WT11S-24132	24	132	1 $\frac{1}{2}$		1508	110
	_WT11S-24144	24	144	1 $\frac{1}{2}$		1616	120

Profile front edge only

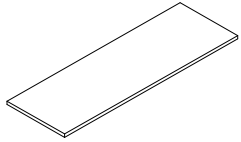
Description	Model Number	Overall Dimensions (in.)			Notes	Price (US\$)	Weight (lbs.)
		Depth	Width	Height			
Worksurface 	_WT11S-3016	30	16	1½		519	17
	_WT11S-3019	30	19	1½		544	20
	_WT11S-3030	30	30	1½		651	31
	_WT11S-3036	30	36	1½		709	38
	_WT11S-3042	30	42	1½		767	44
	_WT11S-3048	30	48	1½		820	50
	_WT11S-3054	30	54	1½		879	56
	_WT11S-3060	30	60	1½		935	63
	_WT11S-3066	30	66	1½		993	69
	_WT11S-3072	30	72	1½		1066	75
	_WT11S-3078	30	78	1½		1121	81
	_WT11S-3084	30	84	1½		1180	88
	_WT11S-3090	30	90	1½		1237	94
	_WT11S-3096	30	96	1½		1298	100
	_WT11S-30108	30	108	1½		1412	113
	_WT11S-30120	30	120	1½		1531	125
_WT11S-30132	30	132	1½		1645	138	
_WT11S-30144	30	144	1½		1762	150	

Profile front edge only

Worksurface 	_WT12S-3060	30	60	1½		935	63
	_WT12S-3066	30	66	1½		993	69
	_WT12S-3072	30	72	1½		1066	75
	_WT12S-3078	30	78	1½		1121	81
	_WT12S-3084	30	84	1½		1180	88
	_WT12S-3090	30	90	1½		1237	94
	_WT12S-3096	30	96	1½		1298	100

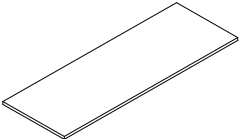

Profile front and back edges

Description	Model Number	Overall Dimensions (in.)			Notes	Price (US\$)	Weight (lbs.)
		Depth	Width	Height			
Worksurface 	_WT11S-3660	36	60	1½		1019	75
	_WT11S-3666	36	66	1½		1083	83
	_WT11S-3672	36	72	1½		1156	90
	_WT11S-3678	36	78	1½		1220	98
	_WT11S-3684	36	84	1½		1282	105
	_WT11S-3690	36	90	1½		1346	113
	_WT11S-3696	36	96	1½		1409	120
	_WT11S-36108	36	108	1½		1532	135
	_WT11S-36120	36	120	1½		1658	150
	_WT11S-36132	36	132	1½		1781	165
	_WT11S-36144	36	144	1½		1908	180

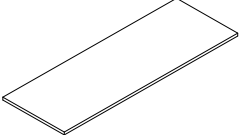
Profile front edge only

Worksurface 	_WT12S-3660	36	60	1½		1019	75
	_WT12S-3666	36	66	1½		1083	83
	_WT12S-3672	36	72	1½		1156	90
	_WT12S-3678	36	78	1½		1220	98
	_WT12S-3684	36	84	1½		1282	105
	_WT12S-3690	36	90	1½		1346	113
	_WT12S-3696	36	96	1½		1409	120

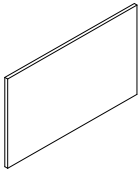
Profile front and back edges

Description	Model Number	Overall Dimensions (in.)			Notes	Price (US\$)	Weight (lbs.)
		Depth	Width	Height			
Modesty Panel 	xWM2-13027	¾	30	27¼		299	17
	xWM2-13627	¾	36	27¼		330	20
	xWM2-14227	¾	42	27¼		363	24
	xWM2-14827	¾	48	27¼		394	27
	xWM2-15427	¾	54	27¼		425	30
	xWM2-16027	¾	60	27¼		457	34
	xWM2-16627	¾	66	27¼		488	37
	xWM2-17227	¾	72	27¼		519	41
	xWM2-17827	¾	78	27¼		549	44
	xWM2-18427	¾	84	27¼		581	47
	xWM2-19027	¾	90	27¼		612	51
	xWM2-19627	¾	96	27¼		644	54
	xWM2-110227	¾	102	27¼		674	57
	xWM2-110827	¾	108	27¼		708	61
	xWM2-111427	¾	114	27¼		738	64
	xWM2-112027	¾	120	27¼		771	68
	xWM2-112627	¾	126	27¼		801	71
	xWM2-113227	¾	132	27¼		832	74
	xWM2-113827	¾	138	27¼		860	78
	xWM2-114427	¾	144	27¼		891	81
Keel 	xWM2-1483	¾	48	3		260	3
	xWM2-1543	¾	54	3		278	3
	xWM2-1603	¾	60	3		292	4
	xWM2-1663	¾	66	3		310	4
	xWM2-1723	¾	72	3		326	5
	xWM2-1783	¾	78	3		339	5
	xWM2-1843	¾	84	3		357	5
	xWM2-1903	¾	90	3		374	6
	xWM2-1963	¾	96	3		389	6
	xWM2-11023	¾	102	3		404	6
	xWM2-11083	¾	108	3		424	7
	xWM2-11143	¾	114	3		437	7
	xWM2-11203	¾	120	3		456	8
	xWM2-11263	¾	126	3		471	8
	xWM2-11323	¾	132	3	(note: call factory for finished back pricing on anchor and hi-rise storage units)	486	8
	xWM2-11383	¾	138	3		503	9
	xWM2-11443	¾	144	3		517	9

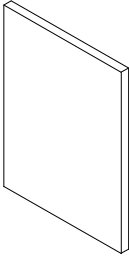
Description	Model Number	Overall Dimensions (in.)			Price (US\$)	Weight (lbs.)
		Depth	Width	Height		
End Panel 	_xWE2-2027	20	1¼	27¼	404	32
	_xWE2-2427	24	1¼	27¼	421	36
	_xWE2-3027	30	1¼	27¼	446	41
	_xWE2-3627	36	1¼	27¼	473	47
	_xWE2-4227	42	1¼	27¼	498	53
	_xWE2-4827	48	1¼	27¼	523	58
	_xWE2-5427	54	1¼	27¼	546	64
	_xWE2-6027	60	1¼	27¼	571	69
	_xWE2-6627	66	1¼	27¼	597	75
	_xWE2-7227	72	1¼	27¼	623	81
	_xWE2-7827	78	1¼	27¼	648	86
	_xWE2-8427	84	1¼	27¼	671	92
	_xWE2-9027	90	1¼	27¼	696	97
	_xWE2-9627	96	1¼	27¼	721	103

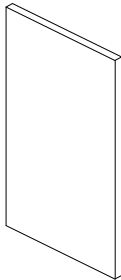
End panel 	_xWE2-2041	20	1¼	41¼	579	48
	_xWE2-2441	24	1¼	41¼	602	54
	_xWE2-3041	30	1¼	41¼	638	63
	_xWE2-3641	36	1¼	41¼	675	71
	_xWE2-4241	42	1¼	41¼	710	80
	_xWE2-4841	48	1¼	41¼	747	88
	_xWE2-5441	54	1¼	41¼	780	97
	_xWE2-6041	60	1¼	41¼	817	105
	_xWE2-6641	66	1¼	41¼	852	114
	_xWE2-7241	72	1¼	41¼	888	122
	_xWE2-7841	78	1¼	41¼	922	131
	_xWE2-8441	84	1¼	41¼	959	140
	_xWE2-9041	90	1¼	41¼	995	148
	_xWE2-9641	96	1¼	41¼	1030	157

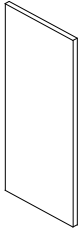
Description	Model Number	Overall Dimensions (in.)			Notes	Price (US\$)	Weight (lbs.)
		Depth	Width	Height			
End Panel 	_xWE2-2051	20	1¼	50½		630	60
	_xWE2-2451	24	1¼	50½		658	67
	_xWE2-3051	30	1¼	50½		701	78
	_xWE2-3651	36	1¼	50½		743	89
	_xWE2-4251	42	1¼	50½		786	99
	_xWE2-4851	48	1¼	50½		832	110
	_xWE2-5451	54	1¼	50½		874	120
	_xWE2-6051	60	1¼	50½		917	131
	_xWE2-6651	66	1¼	50½		959	142
	_xWE2-7251	72	1¼	50½		1004	152
	_xWE2-7851	78	1¼	50½		1047	163
	_xWE2-8451	84	1¼	50½		1089	174
	_xWE2-9051	90	1¼	50½		1132	184
	_xWE2-9651	96	1¼	50½		1174	195

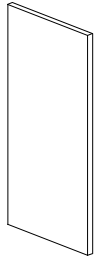
End Panel 	_xWE2-2071	20	1¼	70½		743	84
	_xWE2-2471	24	1¼	70½		783	94
	_xWE2-3071	30	1¼	70½		845	108
	_xWE2-3671	36	1¼	70½		905	123
	_xWE2-4271	42	1¼	70½		967	138
	_xWE2-4871	48	1¼	70½		1027	153
	_xWE2-5471	54	1¼	70½		1089	168
	_xWE2-6071	60	1¼	70½		1149	182

Provided in sections up to 96" long

End Panel 	_xWE2-2083	20	1¼	82½		805	98
	_xWE2-2483	24	1¼	82½		852	110
	_xWE2-3083	30	1¼	82½		922	127
	_xWE2-3683	36	1¼	82½		993	144
	_xWE2-4283	42	1¼	82½		1064	161
	_xWE2-4883	48	1¼	82½		1135	179
	_xWE2-5483	54	1¼	82½		1205	196
	_xWE2-6083	60	1¼	82½		1277	213

Description

Model Number

Overall Dimensions (in.)
Depth Width Height

Notes

Price
(US\$)

Weight
(lbs.)

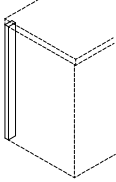
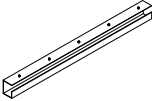
Description	Model Number	Overall Dimensions (in.)			Notes	Price (US\$)	Weight (lbs.)
		Depth	Width	Height			
Filler Strip	qWR3-27	13/16	1½	27¼	Used to fill rear overhang area at end of worksurface runs or on open back credenzas where overhang is considered objectionable.	85	
							
Perimeter Wall Mount Kit	AMWB-size	3	12-96	4	Used to mount worksurfaces to perimeter walls. Includes wire trough and foam edge gasket.	20	per lin. ft.
							
Provided in sections up to 96" long							
Wall Mount End Cap	AMWB-CAP	3	4	4	Used to trim out exposed end of Wall Mount Kit when used with Eddy worksurface or other conditions where Wall Mount Kit end is visible.	38	
