

PRIMA VISTA

designed by Tom McHugh

Prima Vista is a dynamic contemporary statement that features a sweeping bowfront flanked by high sidewalls. A thick prow edged transaction surface "floats" at 40", 3/8" above this bowfront on bullnosed dentils. This top may be specified in matching or contrasting wood, stone, or leather wrapped. The bowfront is standard in flat cut cherry to match the sidewalls, but may be optioned as birdseye maple, sycamore or laurel burl with black accents. A 3/8" accent bead on the sidewalls can be finished in natural maple, black, or to match the sidewalls. Sidewalls are 46 5/8" high and capped in shaped, solid wood. Black locks are standard on all drawers and are keyed alike by set-up.

Due to the unique detailing of this product, desk/return or desk/bridge/credenza configurations feature unbroken side panels. See the following configuration and individual component pricing pages for further information.

This price list allows a certain amount of flexibility with the drawer storage components. The box/box/file pedestals (6-6-12) indicated with the letters A or C and the file/file (12-12) indicated with the letters B or D are interchangeable. Within the model number, the letters after the dimensional numbers communicate the drawer configuration. These letters indicate the sequence and type of drawer storage on the unit. The A, B, C and D pedestals are interchangeable at the same price. All Configurations illustrated include one C and one D pedestal.

The overall dimensions indicated include any protrusions, overhang or thickness of detail(s). When multiple components are configured together to form large assemblies, these detail dimensions will include the elimination of conflicting or duplicated detail. Top dimensions indicated are for the net (usable) worksurface area.

Additional finish options may easily be specified on Prima Vista bowfronts. Please contact your CCN Representative for more information on pricing and availability.

CONFIGURATION EXAMPLES

Description

Notes

Price (US\$) **Weight (lbs.)**

"U" Configuration Side Entry

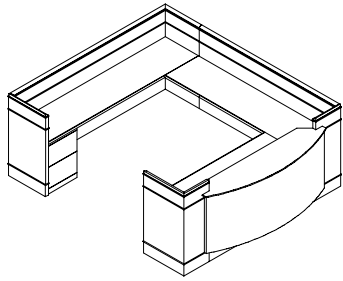

VGCL-11086-DC-GL4
 overall dimension 110"D x 86"W x 46⁵/₈"H
 Desk top: 23" x 82"
 Bridge top: 21³/₄" x 50"
 Credenza top: 23" x 82"

legal width b/b/f & f/f pedestals

22265 1057

VGCL-110100-DC-GL4
 overall dimension 110"D x 100"W x 46⁵/₈"H
 Desk top: 23" x 96"
 Bridge top: 21³/₄" x 50"
 Credenza top: 23" x 96"

legal width b/b/f & f/f pedestals

23346 1124

VGCL-110114-DC-GL4
 overall dimension 110"D x 114"W x 46⁵/₈"H
 Desk top: 23" x 110"
 Bridge top: 21³/₄" x 50"
 Credenza top: 23" x 110"

legal width b/b/f & f/f pedestals

24435 1193

Specify **Left** or **Right** (seated) (**L**eft indicated)

Flat cut cherry w/ matching or contrast finish is standard on bowfront (see page 6 for optional finishes)

"U" Configuration Rear Entry

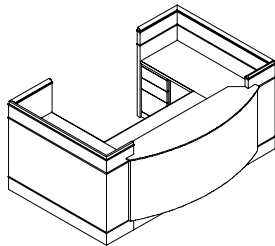

VGM-7286-CD-GL4
 overall dimension 72"D x 86"W x 46⁵/₈"H
 Return top: 21³/₄" x 35"
 Desk top: 23" x 82"
 Return top: 21³/₄" x 35"

legal width b/b/f & f/f pedestals*

20376 918

VGM-72100-CD-GL4
 overall dimension 72"D x 100"W x 46⁵/₈"H
 Return top: 21³/₄" x 35"
 Desk top: 23" x 96"
 Return top: 21³/₄" x 35"

legal width b/b/f & f/f pedestals

21035 954

VGM-72114-CD-GL4
 overall dimension 72"D x 114"W x 46⁵/₈"H
 Return top: 21³/₄" x 35"
 Desk top: 23" x 110"
 Return top: 21³/₄" x 35"

legal width b/b/f & f/f pedestals

21694 991

Flat cut cherry w/ matching or contrast finish is standard on bowfront (see page 6 for optional finishes)

*note: restricted swivel space

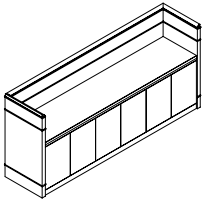
Description	Model Number	Overall Dimensions			Notes	Price (US\$)	Weight (lbs.)
		Depth	Width	Height			
Credenza- Full Hinged Door Storage 	VC0R-2586-HHHH	25	86	46 $\frac{5}{8}$	2 bay, 4 hinged doors	8294	386
	VC0R-25100-HHHHHH	25	100	46 $\frac{5}{8}$	3 bay, 6 hinged doors	9847	437
	VC0R-25114-HHHHHH	25	114	46 $\frac{5}{8}$	3 bay, 6 hinged doors	10271	469

1 adjustable shelf behind each pair of hinged doors

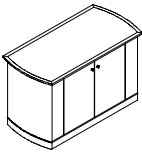
Cabinet- Hinged Door 	VSHW11-2542	25	42	29	1 adjustable shelf, wood top*	4004	166
	VSHW12-254240	25	42	39 $\frac{5}{8}$	2 adjustable shelves, wood top*	4585	223
	VSHW12-254246	25	42	46	2 adjustable shelves, wood top*	4886	241
	VSHW110G-2542				1 adjustable shelf, black granite top	6473	208
	VSHW120G-254240	25	42	39 $\frac{5}{8}$	2 adjustable shelves, black granite top	7151	264
	VSHW120G-254246	25	42	46	2 adjustable shelves, black granite top	7354	283

bow ends

*matching body specie and color or black catalyzed finish (CCHS-16 Onyx)

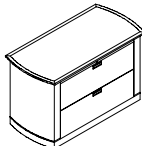
Cabinet- Lateral File 	VFSW102-2542	25	42	29	2- 36"w lateral file drawers, wood top*	4030	241
	VFSW102G-2542	25	42	29	2- 36"w lateral file drawers, black granite top	6495	282

bow ends

*matching body specie and color or black catalyzed finish (CCHS-16 Onyx)

PRIMA VISTA

Above pricing reflects standard cherry and maple finishes. Consult sales representative for any variation of size, configuration, finish or wood species.

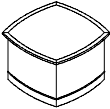
Description	Model Number	Overall Dimensions			Notes	Price (US\$)	Weight (lbs.)
		Depth	Width	Height			
 "Cube" Occasional Table	VTC-212120	21	21	20	wood top*	2598	75
	VTC-272720	27	27	20	wood top*	2810	111
	VTC-383816	38	38	16	wood top*	3215	181
	VTC00G-212120	21	21	20	black granite top	3669	105
	VTC00G-272720	27	27	20	black granite top	4582	161
	VTC00G-383816	38	38	16	black granite top	6720	281
*matching body specie and color or black catalyzed finish (CCHS-16 Onyx)							

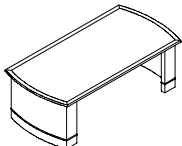
 Occasional Table w/ Panel Ends	VTW3G-254216	25	42	16	wood top*	3442	84
	VTW2G-254816	25	48	16	wood top*	3565	90
	VTW2GG-254216	25	42	16	black granite top	5990	157
	VTW2GG-254816	25	48	16	black granite top	6479	173
*matching body specie and color or black catalyzed finish (CCHS-16 Onyx)							

Bowfront Surface Options:

Transaction Shelf Options:

Flat Cut Cherry w/ Matching or Contrast Finish	n/c
Reverse Box Pattern Birdseye Maple	1862
Diamond Pattern Figured Sycamore	1489
Laurel Burl Diamonds on Flat Cut Cherry Field	1489
Black Diamonds on Flat Cut Cherry Field	791

Matching Body Specie and Color or Black Catalyzed Finish (CCHS-16 Onyx)	n/c
Black Leather Wrapped	785
Black Granite	3259

Organizer Options:

Computer Well Option:

Open to Extend Worksurface	n/c
Vertical Divisions	361
Combination Vertical and Horizontal Divisions	464

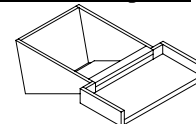

Fixed Keyboard Well

ACW 18"W 17"L 10"D 1572



CROFTON

designed by John L. Bodag

CROFTON, created by CCN International in collaboration with John L. Bodag, Director of Design of Ford & Earl Design Associates is based on the design principles of the Arts & Crafts Movement, a philosophy that held that aesthetics and functionality should co-exist rather than be considered mutually exclusive.

Quartered, Figured White Oak and Quartered Cherry are employed for their clean, linear grain character which reinforces the strong horizontal/vertical interplay. The CROFTON Collection features cantilevered, beveled edge treatments and deep spindle details. Fine craftsmanship is expressed by the accented dovetail keys that punctuate the meticulous joinery.

Drawers and lower hinged doors are flush panels with an integrated, crescent-shaped pull. The pull is offered with a square or radius pattern front and is available in pewertone, bronzetone and blackpowder coat finish.

The design of CROFTON has been carefully developed with proportioning and details intended for maximum visual integrity while still responding to utility. Modifications are not encouraged. Any request for modification of the CROFTON product will necessitate a review by the product designer and will affect CCN's timely response to a special inquiry.

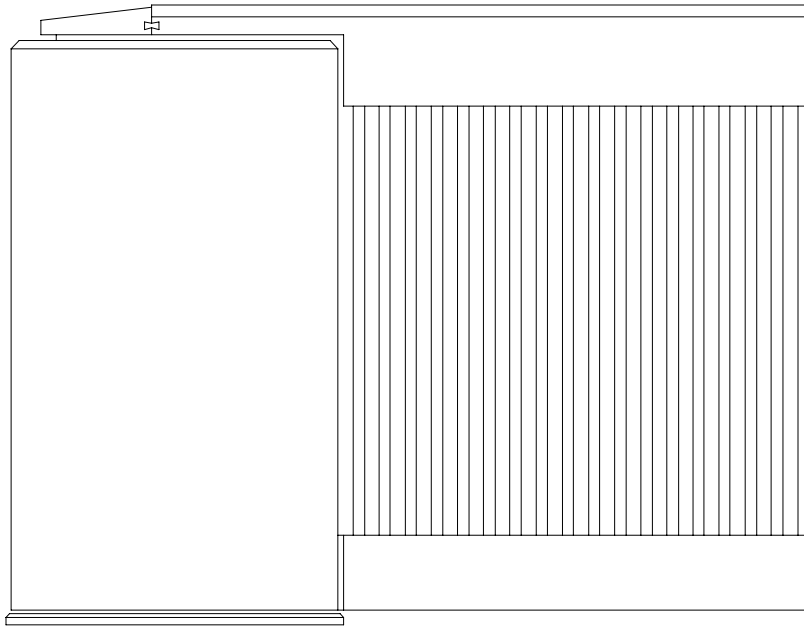

CONFIGURATION EXAMPLES

Description

Notes

**Price
(US\$)**

**Weight
(lbs.)**

Gallery Desk

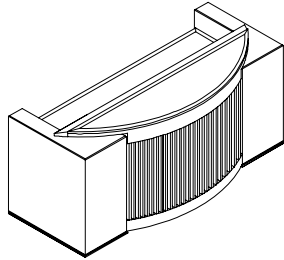

FD0RT-3988-CD-GW2
overall dimension 39¼"D x 88"W x 41⅜"H
Desk top: 30" x 76"

legal width b/b/f & f/f pedestals

28896

866

FD0RT-39106-CD-GW2
overall dimension 39¼"D x 106"W x 41⅜"H
Desk top: 30" x 94"

legal width b/b/f & f/f pedestals

32816

973

Gallery Desk w/ Return

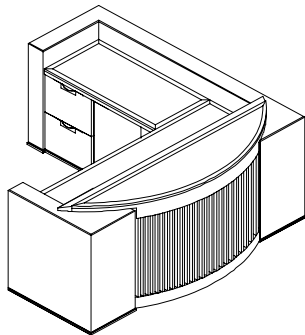

FGAL-8988-CD-GW3
overall dimension 89"D x 88"W x 41⅜"H
Desk top: 30" x 76"
Return top: 22" x 44"

legal width b/b/f & f/f pedestals

35243

1098

FGAL-89106-CD-GW3
overall dimension 89"D x 106"W x 41⅜"H
Desk top: 30" x 94"
Return top: 22" x 44"

legal width b/b/f & f/f pedestals

39162

1205

CONFIGURATION EXAMPLES

Description

Notes

Price (US\$) **Weight (lbs.)**

"U" Configuration Side Entry

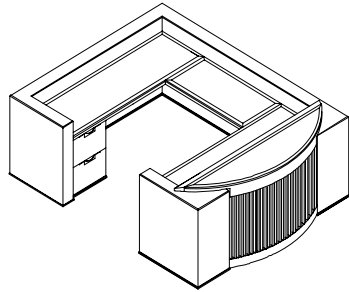

FGCL-88106-DC-GW4
 overall dimension 88"D x 106"W x 41³/₈"H
 Desk top: 30" x 76"
 Bridge top: 22" x 44"
 Credenza top: 24" x 76"

legal width b/b/f & f/f pedestals

43367 1446

FGCL-113106-DC-GW4
 overall dimension 113"D x 106"W x 41³/₈"H
 Desk top: 30" x 94"
 Bridge top: 22" x 44"
 Credenza top: 24" x 94"

legal width b/b/f & f/f pedestals

48220 1611

Specify **Left** or **Right** (seated)

(**L**eft indicated)

"U" Configuration Rear Entry

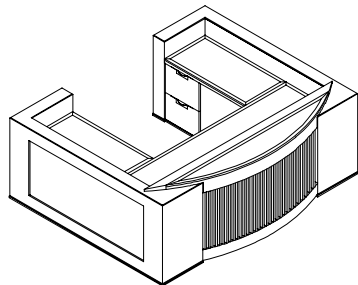

FGM-89106-CD-GW4
 overall dimension 89"D x 106"W x 41³/₈"H
 Return top: 22" x 44"
 Desk top: 30" x 94"
 Return top: 22" x 44"

legal width b/b/f & f/f pedestals

45508 1437

Description	Model Number	Overall Dimensions			Notes	Price (US\$)	Weight (lbs.)
		Depth	Width	Height			
Credenza Full Hinged Door	FC0R-3088-HHHH	30¼	88	43¾	2 bay, 4 hinged doors	12771	544
	FC0R-30106-HHHH	30¼	106	43¾	2 bay, 4 hinged doors	15060	622

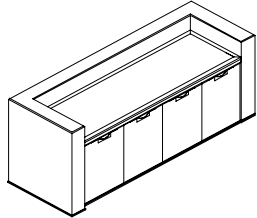

Refer to separate CCN CROFTON pricelist for complete line of matching tables, casegoods, etc

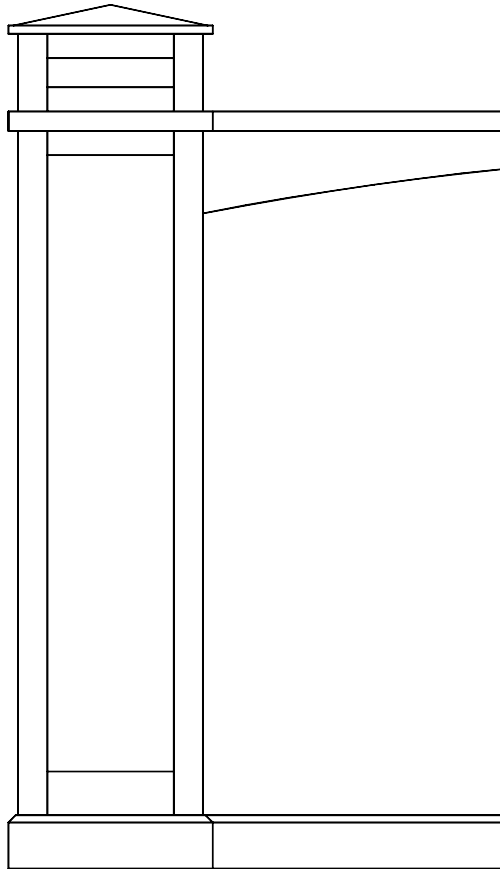

TALISMAN

Talisman's form and detailing recalls and reinterprets the styling of mission and prairie style furniture. 11" x 11" x 44" high corner bollards with pyramidal caps anchor 8½" thick x 39"H panels supporting 1¼" thick worksurfaces. Connections between worksurfaces are made via simple butt joints. A 3" high wood base is employed throughout. The approach side of the desk features a 1" thick transaction surface and a modesty panel recessed 3½" back from an arched transaction surface support. Corner bollards have a 6¼" x 1⅜" inset area at the top which may be specified in a lacewood accent. Black locks are standard on all drawers and are keyed alike by set-up.

This price list allows a certain amount of flexibility with the drawer storage components. The box/box/file pedestals (6-6-12) indicated with the letters A or C and the file/file (12-12) indicated with the letters B or D are interchangeable. Within the model number, the letters after the dimensional numbers communicate the drawer configuration. These letters indicate the sequence and type of drawer storage on the unit. The A, B, C and D pedestals are interchangeable at the same price. All configurations illustrated include one C and one D pedestal.

The overall dimensions indicated include any protrusions, overhang or thickness of detail(s). When multiple components are configured together to form large assemblies, these detail dimensions will include the elimination of conflicting or duplicated detail. Top dimensions indicated are for the net (usable) worksurface area.

Due to the unique detailing of this product, desk/return or desk/bridge/credenza configurations feature unbroken side panels. See the following configuration and individual component pricing pages for further information. In addition, the 8½" thick panels provide the opportunity for extensive accommodation of electrical and data requirements. See separate accessory price list for a listing of accessory items intended for use in such applications.

CONFIGURATION EXAMPLES

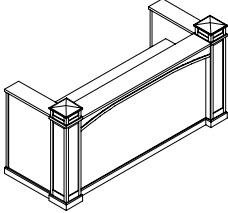
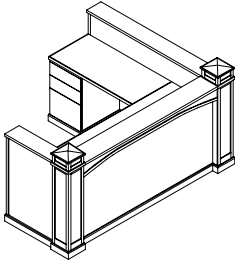
	Description	Notes	Price (US\$)	Weight (lbs.)
Gallery Desk 	ID0RT-3584-AB-GL2 overall dimension 35"D x 84"W x 45"H Desk top: 28" x 62"	letter width b/b/f & f/f pedestals	14524	600
	ID0RT-3596-CD-GL2 overall dimension 35"D x 96"W x 45"H Desk top: 28" x 74"	legal width b/b/f & f/f pedestals	14801	630
	ID0RT-35108-CD-GL2 overall dimension 35"D x 108"W x 45"H Desk top: 28" x 86"	legal width b/b/f & f/f pedestals	15076	660
Gallery Desk w/ Return 	IGAL-8584-AB-GL3 overall dimension 85"D x 84"W x 45"H Desk top: 28" x 62" Return top: 20" x 50"	letter width b/b/f & f/f pedestals	16958	749
	IGAL-8596-CD-GL3 overall dimension 85"D x 96"W x 45"H Desk top: 28" x 74" Return top: 24" x 50"	legal width b/b/f & f/f pedestals	17321	787
	IGAL-85108-CD-GL3 overall dimension 85"D x 108"W x 45"H Desk top: 28" x 86" Return top: 24" x 50"	legal width b/b/f & f/f pedestals	17596	817
Specify Left or Right (seated)	(Left indicated)			

CONFIGURATION EXAMPLES

Description

Notes

**Price
(US\$)**

**Weight
(lbs.)**

"U" Configuration Side Entry

IGCL-11684-BA-GL4
overall dimension 116"D x 84"W x 45"H
Desk top: 28" x 62"
Bridge top: 20" x 50"
Credenza top: 20" x 62"

letter width b/b/f & f/f pedestals

28014

1221

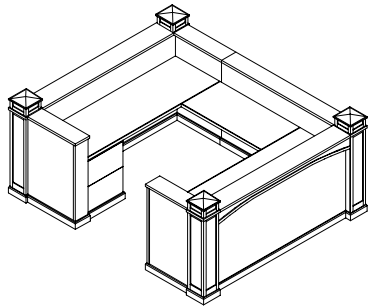

IGCL-11696-DC-GL4
overall dimension 116"D x 96"W x 45"H
Desk top: 28" x 74"
Bridge top: 24" x 50"
Credenza top: 20" x 74"

legal width b/b/f & f/f pedestals

28627

1280

IGCL-116108-DC-GL4
overall dimension 116"D x 108"W x 45"H
Desk top: 28" x 88"
Bridge top: 24" x 50"
Credenza top: 20" x 88"

legal width b/b/f & f/f pedestals

29168

1332

Specify **L**eft or **R**ight (seated)

(**L**eft indicated)

"U" Configuration Rear Entry

IGM-8596-CD-GL4
overall dimension 85"D x 96"W x 45"H
Return top: 20" x 50"
Desk top: 28" x 74"
Return top: 20" x 50"

legal width b/b/f & f/f pedestals

19669

928

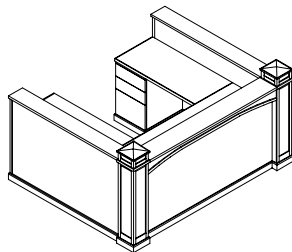

IGM-85108-CD-GL4
overall dimension 85"D x 108"W x 45"H
Return top: 24" x 50"
Desk top: 28" x 86"
Return top: 24" x 50"

legal width b/b/f & f/f pedestals

20116

974

CONFIGURATION EXAMPLES

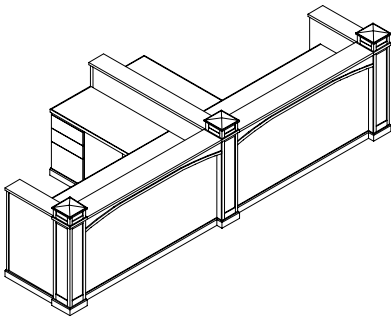
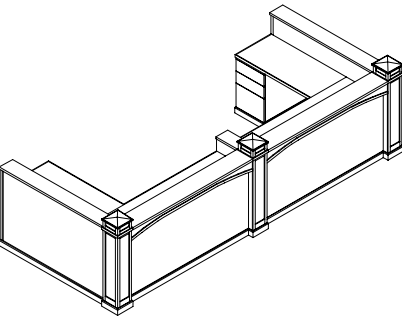
	Description	Notes	Price (US\$)	Weight (lbs.)
<p>Tandem "T" Workstation</p> 	<p>IGF-85157-BAAB-GL6 overall dimension 85"D x 157"W x 45"H Desk top (2): 28" x 62" Return top (2): 20" x 50"</p>	letter width b/b/f & f/f pedestals	29484	1257
	<p>IGF-85181-DCCD-GL6 overall dimension 85"D x 181"W x 45"H Desk top (2): 28" x 74" Return top (2): 24" x 50"</p>	legal width b/b/f & f/f pedestals	30190	1332
	<p>IGF-85205-DCCD-GL6 overall dimension 85"D x 205"W x 45"H Desk top (2): 28" x 88" Return top (2): 24" x 50"</p>	legal width b/b/f & f/f pedestals	30739	1392
<p>Tandem "U" Workstation</p> 	<p>IGB-85157-ABBA-GL6 overall dimension 85"D x 157"W x 45"H Desk top (2): 28" x 62" Return top (2): 20" x 50"</p>	letter width b/b/f & f/f pedestals	30678	1358
	<p>IGB-85181-CDDC-GL6 overall dimension 85"D x 181"W x 45"H Desk top (2): 28" x 74" Return top (2): 24" x 50"</p>	legal width b/b/f & f/f pedestals	31408	1434
	<p>IGB-85205-CDDC-GL6 overall dimension 85"D x 205"W x 45"H Desk top (2): 28" x 88" Return top (2): 24" x 50"</p>	legal width b/b/f & f/f pedestals	31957	1494

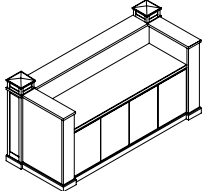
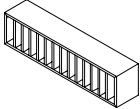
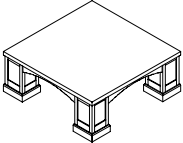
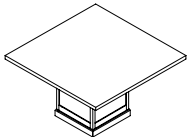
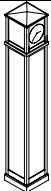
Description	Model Number	Overall Dimensions			Notes	Price (US\$)	Weight (lbs.)
		Depth	Width	Height			
Credenza- Full Hinged Door Storage 	IC0R-2984-HHHH	29	84	45	2 bay, 4 hinged doors	13704	601
	IC0R-2996-HHHH	29	96	45	2 bay, 4 hinged doors	13967	623
	IC0R-29108-HHHH	29	108	45	2 bay, 4 hinged doors	14233	645
1 adjustable shelf behind each pair of hinged doors							
Message Center	AMC	30	7¼	47/8		1384	20
							
Occasional Table w/ Legs	ITS4L-424216	42	42	16		3373	83
	ITS4L-484816	48	48	16		3965	103
							
Occasional Table w/ Cube Base	ITS1C-303016	30	30	16	15" square base	1872	96
	ITS1C-363616	36	36	16	18" square base	2006	110
	ITS1C-424216	42	42	16	21" square base	2159	126
	ITS1C-484816	48	48	16	24" square base	2767	153
							
Clock	IK0-1124	11	11	24	Hinged door front	2489	40
	IK0-1176	11	11	76	Hinged door front with interior shelves	3183	108
							



KUBIT

Kubit is a contemporary design which features a 3/4" thick x 12" deep tempered glass transaction surface raised 3" above the wood case on 1 1/4" diam. stainless steel posts. The case pieces are simple rectilinear elements with 4" high solid wood bases which are recessed 3/4". Worksurfaces are 1 1/4" thick with a square edge. Connections between worksurfaces are made via simple butt joints. Black locks are standard on all drawers and are keyed alike by set-up. The transaction surface is standard in tempered glass, but may be specified in granite at an upcharge.

This price list allows a certain amount of flexibility with the drawer storage components. The box/box/file pedestals (6-6-12) indicated with the letters A or C and the file/file (12-12) indicated with the letters B or D are interchangeable. Within the model number, the letters after the dimensional numbers communicate the drawer configuration. These letters indicate the sequence and type of drawer storage on the unit. The C and D pedestals are interchangeable at the same price. All Configurations illustrated include one C and one D pedestal.

The overall dimensions indicated include any protrusions, overhang or thickness of detail(s). When multiple components are configured together to form large assemblies, these detail dimensions will include the elimination of conflicting or duplicated detail. Top dimensions indicated are for the net (usable) worksurface area.

Because of the clean mitered joinery and flush veneer panels, Kubit lends itself to the use of exotic veneers. Market values on these materials vary, so it is necessary to contact your CCN Representative for more information on pricing and availability. Species offered include Figured Anigre, Figured Sycamore, Laurel Burl, and Birdseye Maple.

CONFIGURATION EXAMPLES

Description

Notes

**Price
(US\$)**

**Weight
(lbs.)**

Gallery Desk

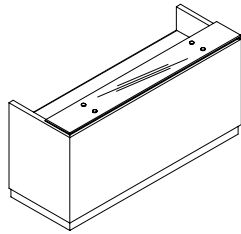

KD0RA-3072-CD-GL2
overall dimension 30"D x 72"W x 42"H
Desk top: 27¾" x 68"

legal width b/b/f & f/f pedestals

11562

466

KD0RA-3084-CD-GL2
overall dimension 30"D x 84"W x 42"H
Desk top: 27¾" x 80"

legal width b/b/f & f/f pedestals

12170

505

KD0RA-3096-CD-GL2
overall dimension 30"D x 96"W x 42"H
Desk top: 27¾" x 92"

legal width b/b/f & f/f pedestals

12776

543

Gallery Desk w/ Return

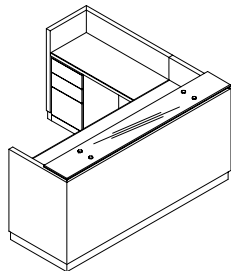

KGAL-7872-CD-GL3
overall dimension 78"D x 72"W x 42"H
Desk top: 27¾" x 68"
Return top: 19" x 46"

legal width b/b/f & f/f pedestals

14372

579

KGAL-7884-CD-GL3
overall dimension 78"D x 84"W x 42"H
Desk top: 27¾" x 80"
Return top: 24" x 46"

legal width b/b/f & f/f pedestals

15124

632

KGAL-7896-CD-GL3
overall dimension 78"D x 96"W x 42"H
Desk top: 27¾" x 92"
Return top: 24" x 46"

legal width b/b/f & f/f pedestals

15730

670

Specify **Left** or **Right** (seated)

(**L**eft indicated)



Above pricing reflects standard cherry and maple finishes. Consult sales representative for any variation of size, configuration, finish or wood species.

CONFIGURATION EXAMPLES

Description

Notes

**Price
(US\$)**

**Weight
(lbs.)**

"U" Configuration Side Entry

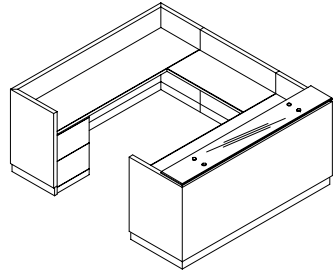

KGCL-10272-DC-GL4
 overall dimension 102"D x 72"W x 42"H
 Desk top: 27¾" x 68"
 Bridge top: 19" x 46"
 Credenza top: 24" x 68"

legal width b/b/f & f/f pedestals

18031 761

KGCL-10284-DC-GL4
 overall dimension 102"D x 84"W x 42"H
 Desk top: 27¾" x 80"
 Bridge top: 24" x 46"
 Credenza top: 24" x 80"

legal width b/b/f & f/f pedestals

19032 833

KGCL-10296-DC-GL4
 overall dimension 102"D x 96"W x 42"H
 Desk top: 27¾" x 92"
 Bridge top: 24" x 46"
 Credenza top: 24" x 92"

legal width b/b/f & f/f pedestals

19944 896

Specify **Left** or **Right** (seated)

(**L**eft indicated)

"U" Configuration Rear Entry

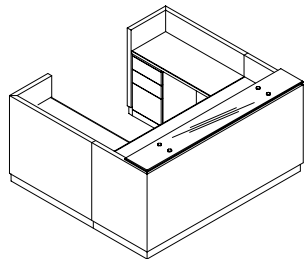

KGGM-8484-CD-GL4
 overall dimension 84"D x 84"W x 42"H
 Return top: 19" x 52"
 Desk top: 27¾" x 80"
 Return top: 19" x 52"

legal width b/b/f & f/f pedestals

18092 753

KGGM-8496-CD-GL4
 overall dimension 84"D x 96"W x 42"H
 Return top: 24" x 52"
 Desk top: 27¾" x 92"
 Return top: 24" x 52"

legal width b/b/f & f/f pedestals

18994 823



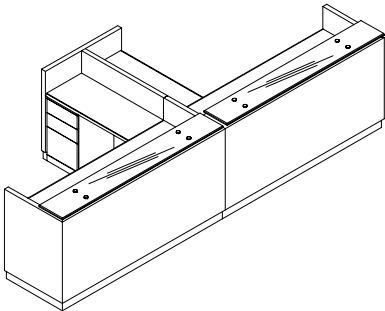
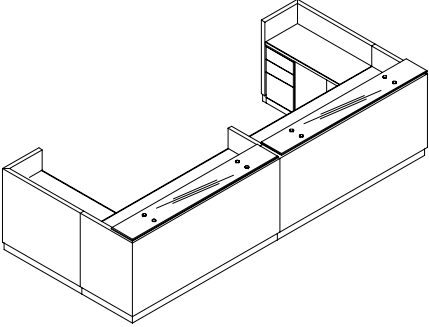

Above pricing reflects standard cherry and maple finishes. Consult sales representative for any variation of size, configuration, finish or wood species.

CONFIGURATION EXAMPLES

	Description	Notes	Price (US\$)	Weight (lbs.)
<p>Tandem "T" Workstation</p> 	<p>KGF-78142-DCCD-GL6 overall dimension 78"D x 142"W x 42"H Desk top (2): 27¾" x 68" Return top (2): 19" x 46"</p>	legal width b/b/f & f/f pedestals	26769	1067
	<p>KGF-78166-DCCD-GL6 overall dimension 78"D x 166"W x 42"H Desk top (2): 27¾" x 80" Return top (2): 24" x 46"</p>	legal width b/b/f & f/f pedestals	28244	1172
	<p>KGF-78190-DCCD-GL6 overall dimension 78"D x 190"W x 42"H Desk top (2): 27¾" x 92" Return top (2): 24" x 46"</p>	legal width b/b/f & f/f pedestals	29459	1249
<p>Tandem "U" Workstation</p> 	<p>KGB-84142-CDDC-GL6 overall dimension 84"D x 142"W x 42"H Desk top (2): 27¾" x 68" Return top (2): 19" x 52"</p>	legal width b/b/f & f/f pedestals	28107	1143
	<p>KGB-84166-CDDC-GL6 overall dimension 84"D x 166"W x 42"H Desk top (2): 27¾" x 80" Return top (2): 24" x 52"</p>	legal width b/b/f & f/f pedestals	29616	1252
	<p>KGB-84190-CDDC-GL6 overall dimension 84"D x 190"W x 42"H Desk top (2): 27¾" x 92" Return top (2): 24" x 52"</p>	legal width b/b/f & f/f pedestals	30831	1329

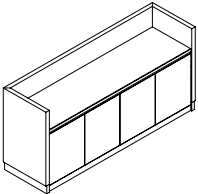

Above pricing reflects standard cherry and maple finishes. Consult sales representative for any variation of size, configuration, finish or wood species.

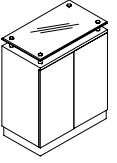
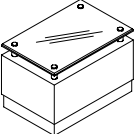
Description	Model Number	Overall Dimensions			Notes	Price (US\$)	Weight (lbs.)
		Depth	Width	Height			
Credenza- Full Hinged Door Storage 	KCOR-2672-HHHH	26	72	38	2 bay, 4 hinged doors	6894	326
	KCOR-2684-HHHH	26	84	38	2 bay, 4 hinged doors	7200	350
	KCOR-2696-HHHHHH	26	96	38	3 bay, 6 hinged doors	8640	395
1 adjustable shelf behind each pair of hinged doors							
Lateral File Storage	KSF0103A-203642	20	36	42	1- 36"w utility drawer 2- 36"w lateral file drawers	5225	275
							
Hinged Door Storage	KSH0120A-203642	20	36	42	2 hinged doors	5091	200
							
2 adjustable shelves							
Occasional Table Cube	KTC00A-303020	30	30	20		3863	165
	KTC00A-363616	36	36	16		4673	210
	KTC00A-424216	42	42	16		5660	273
	KTC00A-204816	20	48	16		4043	176
							

Description	Model Number	Overall Dimensions			Notes	Price (US\$)	Weight (lbs.)
		Depth	Width	Height			
Stone Transaction Surface 	ATTG-1472	14	72	1½	72" black granite transaction top (upgrade)	1592	39
	ATTG-1484	14	84	1½	84" black granite transaction top (upgrade)	1849	45
	ATTG-1496	14	96	1½	96" black granite transaction top (upgrade)	2109	52

CLASSIC

Classic is a reinterpretation of ancient architectural motifs. 10¼" step back corners allow for 8⁵/₈" diameter columns on the desk approach side which support a 3" thick transaction surface detailed with a dentil frieze. The columns and body rest on a 2¹¹/₁₆" high mitered plinth base. Each column is detailed with 4 black rings. Worksurfaces are 1¼" thick with a square edge. Connections between worksurfaces are made via simple butt joints. Black locks are standard on all drawers and are keyed alike by set-up.

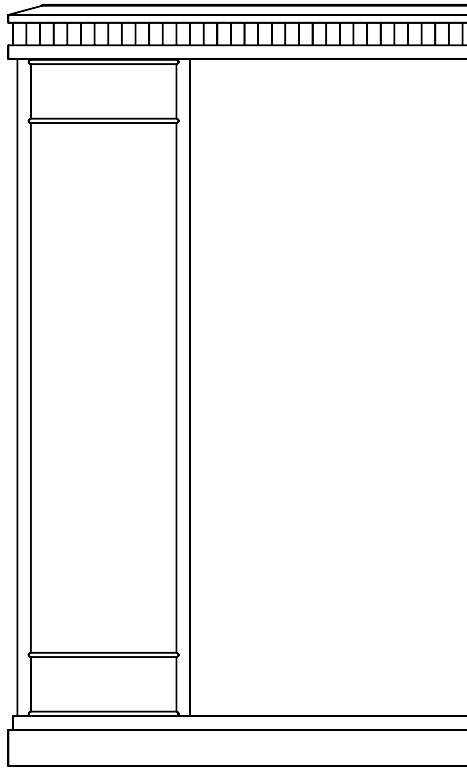

This price list allows a certain amount of flexibility with the drawer storage components. The box/box/file pedestals (6-6-12) indicated with the letters A or C and the file/file (12-12) indicated with the letters B or D are interchangeable. Within the model number, the letters after the dimensional numbers communicate the drawer configuration. These letters indicate the sequence and type of drawer storage on the unit. The A, B, C and D pedestals are interchangeable at the same price. All configurations illustrated include one C and one D pedestal.

The overall dimensions indicated include any protrusions, overhang or thickness of detail(s). When multiple components are configured together to form large assemblies, these detail dimensions will include the elimination of conflicting or duplicated detail. Top dimensions indicated are for the net (usable) worksurface area.

CONFIGURATION EXAMPLES

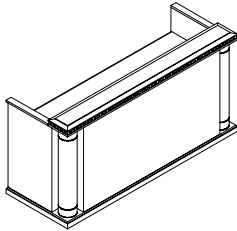
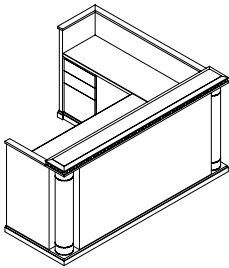
	Description	Notes	Price (US\$)	Weight (lbs.)
Gallery Desk 	LD0RT-3072-AB-GL2 overall dimension 30"D x 72"W x 42"H Desk top: 27" x 67"	letter width b/b/f & f/f pedestals	12615	450
	LD0RT-3084-CD-GL2 overall dimension 30"D x 84"W x 42"H Desk top: 27" x 79"	legal width b/b/f & f/f pedestals	13066	483
	LD0RT-3096-CD-GL2 overall dimension 30"D x 96"W x 42"H Desk top: 27" x 91"	legal width b/b/f & f/f pedestals	13515	515
Gallery Desk w/ Return 	LGAL-7872-AB-GL3 overall dimension 78"D x 72"W x 42"H Desk top: 27" x 67" Return top: 19" x 39"	letter width b/b/f & f/f pedestals	15579	559
	LGAL-7884-CD-GL3 overall dimension 78"D x 84"W x 42"H Desk top: 27" x 79" Return top: 19" x 45"	legal width b/b/f & f/f pedestals	16198	603
	LGAL-8496-CD-GL3 overall dimension 84"D x 96"W x 42"H Desk top: 27" x 91" Return top: 23" x 51"	legal width b/b/f & f/f pedestals	16940	659
Specify L eft or R ight (seated)	(L eft indicated)			



Above pricing reflects standard cherry and maple finishes. Consult sales representative for any variation of size, configuration, finish or wood species.

CONFIGURATION EXAMPLES

Description

Notes

**Price
(US\$)**

**Weight
(lbs.)**

"U" Configuration Side Entry

LGCL-9472-DC-GL4
 overall dimension 94"D x 72"W x 42"H
 Desk top: 27" x 67"
 Bridge top: 19" x 42"
 Credenza top: 19" x 67"

legal width b/b/f & f/f pedestals

19414

726

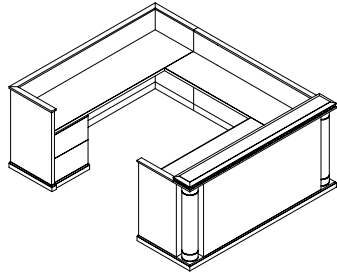

LGCL-10084-DC-GL4
 overall dimension 100"D x 84"W x 42"H
 Desk top: 27" x 79"
 Bridge top: 19" x 48"
 Credenza top: 19" x 79"

legal width b/b/f & f/f pedestals

20372

794

LGCL-10096-DC-GL4
 overall dimension 100"D x 96"W x 42"H
 Desk top: 27" x 91"
 Bridge top: 23" x 48"
 Credenza top: 19" x 91"

legal width b/b/f & f/f pedestals

21400

869

Specify **Left** or **Right** (seated)

(**L**eft indicated)

"U" Configuration Rear Entry

LGM-7884-CD-GL4
 overall dimension 78"D x 84"W x 42"H
 Return top: 19" x 45"
 Desk top: 27" x 79"
 Return top: 19" x 45"

legal width b/b/f & f/f pedestals

19330

723

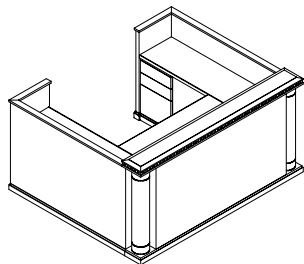

LGM-8496-CD-GL4
 overall dimension 84"D x 96"W x 42"H
 Return top: 23" x 51"
 Desk top: 27" x 91"
 Return top: 23" x 51"

legal width b/b/f & f/f pedestals

20362

803

CONFIGURATION EXAMPLES

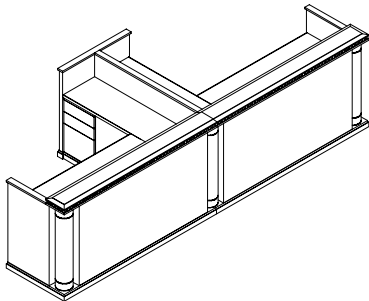
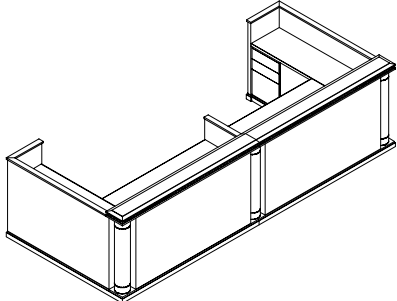
	Description	Notes	Price (US\$)	Weight (lbs.)
<p>Tandem "T" Workstation</p> 	<p>LGF-78141-BAAB-GL6 overall dimension 78"D x 141"W x 42"H Desk top (2): 27" x 69" Return top (2): 19" x 39"</p>	letter width b/b/f & f/f pedestals	28356	1020
	<p>LGF-78165-DCCD-GL6 overall dimension 78"D x 165"W x 42"H Desk top (2): 27" x 79" Return top (2): 19" x 45"</p>	legal width b/b/f & f/f pedestals	29485	1101
	<p>LGF-84189-DCCD-GL6 overall dimension 84"D x 189"W x 42"H Desk top (2): 27" x 91" Return top (2): 23" x 51"</p>	legal width b/b/f & f/f pedestals	30833	1207
<p>Tandem "U" Workstation</p> 	<p>LGB-78141-ABBA-GL6 overall dimension 78"D x 141"W x 42"H Desk top (2): 27" x 69" Return top (2): 19" x 39"</p>	letter width b/b/f & f/f pedestals	29434	1071
	<p>LGB-78165-CDDC-GL6 overall dimension 78"D x 165"W x 42"H Desk top (2): 27" x 79" Return top (2): 19" x 45"</p>	legal width b/b/f & f/f pedestals	30672	1158
	<p>LGB-84189-CDDC-GL6 overall dimension 84"D x 189"W x 42"H Desk top (2): 27" x 91" Return top (2): 23" x 51"</p>	legal width b/b/f & f/f pedestals	32152	1271

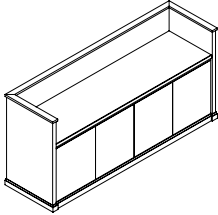
Description	Model Number	Overall Dimensions			Notes	Price (US\$)	Weight (lbs.)
		Depth	Width	Height			
Credenza Full Hinged Door Storage 	LC0R-2272-HHHH	22	72	40	2 bay, 4 hinged doors	7147	314
	LC0R-2284-HHHH	22	84	40	2 bay, 4 hinged doors	7485	337
	LC0R-2296-HHHHHH	22	96	40	3 bay, 6 hinged doors	8951	381

1 adjustable shelf behind each pair of hinged doors

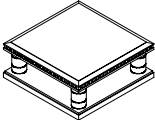
Occasional Table w/ legs 	LTS4L-303020	30	30	20		2813	91
	LTS4L-363616	36	36	16		2996	119
	LTS4L-424216	42	42	16		3232	157
	LTS4L-304816	30	48	16		3094	131



SCULPTURE

Sculpture is a contemporary design that combines the intersection of solid geometric forms. The 8" thick front transaction element is the focal point of the piece and is available in stone or contrasting wood finishes. The body of the desk incorporates 2" thick 42"h wood gallery panels, 1¼" thick wood worksurfaces, and wood storage elements. Square edged worksurfaces connect via simple butt joints. Black locks are standard on all drawers and are keyed alike by set-up.

Due to the unique detailing of this product, desk/return or desk/bridge/credenza configurations feature unbroken side panels. See the following configuration and individual component pricing pages for further information.

This price list allows a certain amount of flexibility with the drawer storage components. The box/box/file pedestals (6-6-12) indicated with the letters A or C and the file/file (12-12) indicated with the letters B or D are interchangeable. Within the model number, the letters after the dimensional numbers communicate the drawer configuration. These letters indicate the sequence and type of drawer storage on the unit. The A, B, C and D pedestals are interchangeable at the same price. All configurations illustrated include one C and one D pedestal.

The overall dimensions indicated include any protrusions, overhang or thickness of detail(s). When multiple components are configured together to form large assemblies, these detail dimensions will include the elimination of conflicting or duplicated detail. Top dimensions indicated are for the net (usable) worksurface area.

Empress Green marble or Black Absolute granite are the standard stone offerings and Cherry or Maple are the standard wood offerings for the 38"h desk front which may be finished in matching or contrasting colors. Additional finishes and exotic veneer options are available upon request. Please submit sample for match and pricing.

CONFIGURATION EXAMPLES

Description

Notes

Price (US\$)
Wood Stone

Weight (lbs.)

Gallery Desk

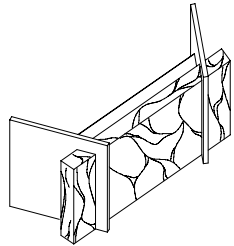

UD0R-4784-AB-GL2
 overall dimension 46½"D x 84"W x 42"H
 Desk top: 27" x 73"

letter width b/b/f & f/f pedestals

9402 19650 801

UD0R-4796-CD-GL2
 overall dimension 46½"D x 96"W x 42"H
 Desk top: 27" x 85"

legal width b/b/f & f/f pedestals

9723 21062 860

"V" Configuration

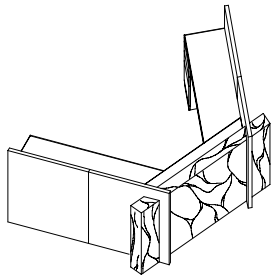

UGM-92106-CD-GL4
 overall dimension 92"D x 106"W x 42"H
 Return top: 18½" x 61½"
 Desk top: 27" x 73"
 Return top: 18½" x 61½"

legal width b/b/f & f/f pedestals

14358 24608 1047

UGM-92118-CD-GL4
 overall dimension 92"D x 118"W x 42"H
 Return top: 23½" x 61½"
 Desk top: 27" x 85"
 Return top: 23½" x 61½"

legal width b/b/f & f/f pedestals

14891 26231 1128

Half "V" Configuration

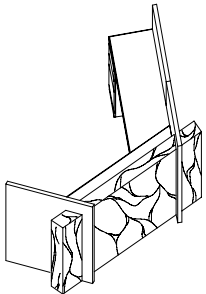

UGAL-9295-CD-GL3
 overall dimension 92"D x 95"W x 42"H
 Desk top: 27" x 73"
 Return top: 18½" x 61½"

legal width b/b/f & f/f pedestals

11880 22131 924

UGAL-92107-CD-GL3
 overall dimension 92"D x 107"W x 42"H
 Desk top: 27" x 85"
 Return top: 23½" x 61½"

legal width b/b/f & f/f pedestals

12309 23646 994

Specify **Left** or **Right** (seated)

(**Left** indicated)

S C U L P T U R E

Above pricing reflects standard cherry and maple finishes. Consult sales representative for any variation of size, configuration, finish or wood species.

CONFIGURATION EXAMPLES

Description

Notes

Price (US\$)
Wood Stone

Weight (lbs.)

"U" Configuration Side Entry

UGCL-11084-DC-GL4
 overall dimension 110"D x 84"W x 42"H
 Desk top: 27" x 73"
 Bridge top: 18½" x 51½"
 Credenza top: 24" x 80"

legal width b/b/f & f/f pedestals

16628

26879

1150

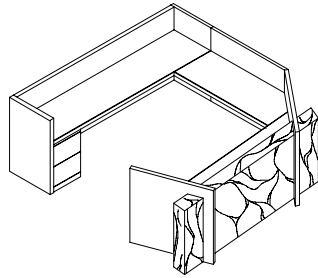

UGCL-11096-DC-GL4
 overall dimension 110"D x 96"W x 42"H
 Desk top: 27" x 85"
 Bridge top: 23½" x 51½"
 Credenza top: 24" x 92"

legal width b/b/f & f/f pedestals

17345

28682

1244

Specify **Left** or **Right** (seated)

(**L**eft indicated)

"U" Configuration Rear Entry

UGM-8484-CD-GL4
 overall dimension 84"D x 84"W x 42"H
 Return top: 18½" x 51½"
 Desk top: 27" x 73"
 Return top: 18½" x 51½"

legal width b/b/f & f/f pedestals

14388

24638

1007

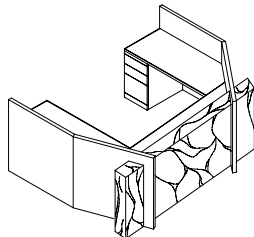

UGM-8496-CD-GL4
 overall dimension 84"D x 96"W x 42"H
 Return top: 23½" x 51½"
 Desk top: 27" x 85"
 Return top: 23½" x 51½"

legal width b/b/f & f/f pedestals

14909

26249

1084

CONFIGURATION EXAMPLES

Description

Notes

Price (US\$)
Wood Stone

Weight
(lbs.)

"L" Configuration Side Entry

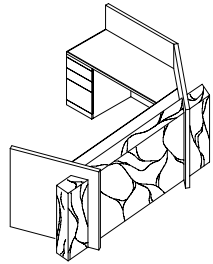

UGAL-8484-CD-GL3
 overall dimension 84"D x 84"W x 42"H
 Desk top: 27" x 73"
 Return top: 18½" x 51½"

legal width b/b/f & f/f pedestals

11894 22146 904

UGAL-8496-CD-GL3
 overall dimension 84"D x 96"W x 42"H
 Desk top: 27" x 85"
 Return top: 23½" x 51½"

legal width b/b/f & f/f pedestals

12318 23655 972

Specify **L**eft or **R**ight (seated)

(**L**eft indicated)

Credenza- Full Hinged Door
 Storage

UC0R-2684-HHHH

26 84 42

2 bay, 4 hinged doors

7354 366

UC0R-2696-HHHHHH

26 96 42

3 bay, 6 hinged doors

8798 412

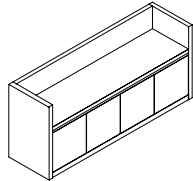

1 adjustable shelf behind each
 pair of hinged doors

Occasional Table Cube

UTC-303018

30 30 18

2063 5187 285

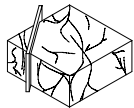

UTC-363618

36 36 18

2329 6360 370

UTC-203022

20 30 22

1928 4804 255

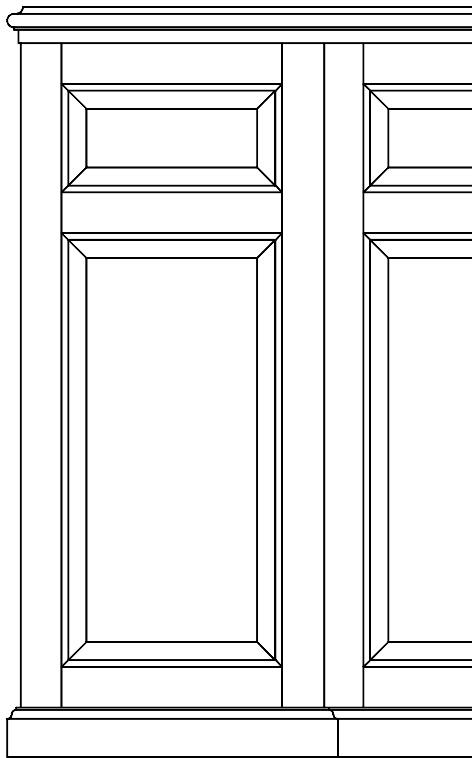

FRANKLIN

Franklin is a traditionally styled grouping with solid wood raised panels employed for vertical surfaces. 2" wide solid rails encase each panel and all rests on a 3" high mitered plinth base. The approach side of the desk features a either a straight stepped front (option 1) or a concave bow front (option 2 - as shown). Work and transaction surfaces are 1¼" thick with an ogee profiled edge. All edges are mitered at the corners. Where return and bridge tops join desk and credenza worksurfaces, the edge is interrupted and continued with an inside mitered connection. Finish on pulls is bright brass. Black locks are standard on all drawers and are keyed alike by set-up.

Due to the unique detailing of this product, desk/return or desk/bridge/credenza configurations feature unbroken side panels. See the following configuration and individual component pricing pages for further information.

This price list allows a certain amount of flexibility with the drawer storage components. The box/box/file pedestals (6-6-12) indicated with the letters A or C and the file/file (12-12) indicated with the letters B or D are interchangeable. Within the model number, the letters after the dimensional numbers communicate the drawer configuration. These letters indicate the sequence and type of drawer storage on the unit. The A, B, C and D pedestals are interchangeable at the same price. All configurations illustrated include one C and one D pedestal.

The overall dimensions indicated include any protrusions, overhang or thickness of detail(s). When multiple components are configured together to form large assemblies, these detail dimensions will include the elimination of conflicting or duplicated detail. Top dimensions indicated are for the net (usable) worksurface area.

CONFIGURATION EXAMPLES

Description

Notes

Price (US\$)
opt 1 opt 2

Weight (lbs.)

Gallery Desk

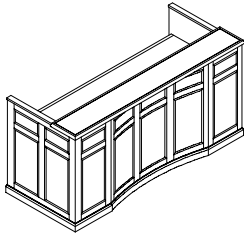

HD0RT-3572-AB-GL2
overall dimension 35"D x 72"W x 42"H
Desk top: 27" x 66½"

letter width b/b/f & f/f pedestals

12847 14778

426

HD0RT-3584-CD-GL2
overall dimension 35"D x 84"W x 42"H
Desk top: 27" x 78½"

legal width b/b/f & f/f pedestals

13548 15802

455

HD0RT-3596-CD-GL2
overall dimension 35"D x 96"W x 42"H
Desk top: 27" x 90½"

legal width b/b/f & f/f pedestals

14250 16828

485

option 1: straight stepped front

option 2: as shown, concave bow front

Gallery Desk w/ Return

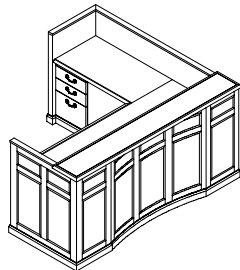

HGAL-8472-AB-GL3
overall dimension 84"D x 72"W x 42"H
Desk top: 27" x 66½"
Return top: 21¾" x 47"

letter width b/b/f & f/f pedestals

16940 18875

529

HGAL-8484-CD-GL3
overall dimension 84"D x 84"W x 42"H
Desk top: 27" x 78½"
Return top: 21¾" x 47"

legal width b/b/f & f/f pedestals

17643 19898

558

HGAL-8496-CD-GL3
overall dimension 84"D x 96"W x 42"H
Desk top: 27" x 90½"
Return top: 21¾" x 47"

legal width b/b/f & f/f pedestals

18343 20921

588

option 1: straight stepped front

option 2: as shown, concave bow front

Specify **L**eft or **R**ight (seated)

(**L**eft indicated)

F R A N K L I N

Above pricing reflects standard cherry and maple finishes. Consult sales representative for any variation of size, configuration, finish or wood species.

CONFIGURATION EXAMPLES

Description

Notes

Price (US\$)
opt 1 opt 2

Weight
(lbs.)

"U" Configuration Side Entry

HGCL-10872-BA-GL4
overall dimension 108"D x 72"W x 42"H
Desk top: 27" x 66½"
Bridge top: 21¾" x 47"
Credenza top: 21¾" x 66½"

letter width b/b/f & f/f pedestals

22719

24654

669

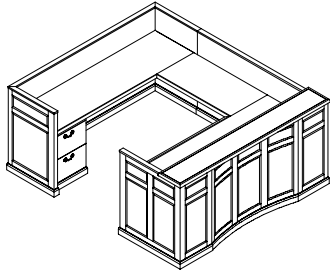

HGCL-10884-DC-GL4
overall dimension 108"D x 84"W x 42"H
Desk top: 27" x 78½"
Bridge top: 21¾" x 47"
Credenza top: 21¾" x 78½"

legal width b/b/f & f/f pedestals

23994

26249

717

HGCL-10896-DC-GL4
overall dimension 108"D x 96"W x 42"H
Desk top: 27" x 90½"
Bridge top: 21¾" x 47"
Credenza top: 21¾" x 90½"

legal width b/b/f & f/f pedestals

25270

27848

766

option 1: straight stepped front

option 2: as shown, concave bow front

Specify **Left** or **Right** (seated)

(Left indicated)

(note: no raised panel detail on back of credenza)

"U" Configuration Rear Entry

HGM-8484-CD-GL4
overall dimension 84"D x 84"W x 42"H
Return top: 21¾" x 47"
Desk top: 27" x 78½"
Return top: 21¾" x 47"

legal width b/b/f & f/f pedestals

21735

23993

661

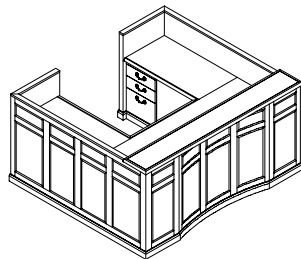

HGM-8496-CD-GL4
overall dimension 84"D x 96"W x 42"H
Return top: 21¾" x 47"
Desk top: 27" x 90½"
Return top: 21¾" x 47"

legal width b/b/f & f/f pedestals

22437

25016

691

option 1: straight stepped front

option 2: as shown, concave bow front

CONFIGURATION EXAMPLES

Description

Notes

Price (US\$)
opt 1 opt 2

Weight (lbs.)

Tandem "T" Workstation

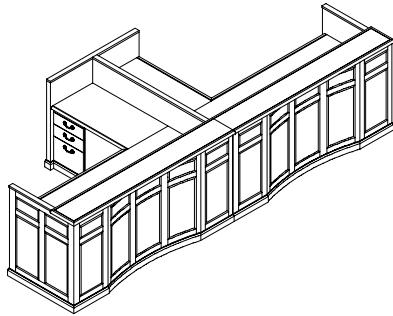

HGF-84141-BAAB-GL6
overall dimension 84"D x 140¾"W x 42"H
Desk top (2): 27" x 66½"
Return top (2): 21¾" x 47"

letter width b/b/f & f/f pedestals

28798

32668

980

HGF-84165-DCCD-GL6
overall dimension 84"D x 164¾"W x 42"H
Desk top (2): 27" x 78½"
Return top (2): 21¾" x 47"

legal width b/b/f & f/f pedestals

30204

34714

1038

HGF-84189-DCCD-GL6
overall dimension 84"D x 188¾"W x 42"H
Desk top (2): 27" x 90½"
Return top (2): 21¾" x 47"

legal width b/b/f & f/f pedestals

31604

36760

1098

option 1: straight stepped front

option 2: as shown, concave bow front

Tandem "U" Workstation

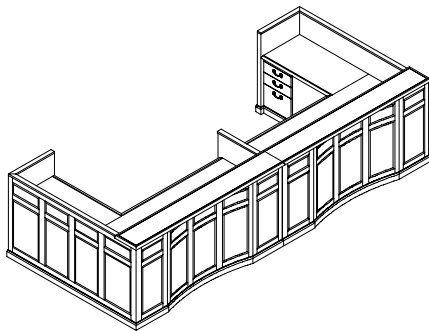

HGB-84141-CDDC-GL6
overall dimension 84"D x 140¾"W x 42"H
Desk top (2): 27" x 66½"
Return top (2): 21¾" x 47"

legal width b/b/f & f/f pedestals

31918

35785

1014

HGB-84165-CDDC-GL6
overall dimension 84"D x 164¾"W x 42"H
Desk top (2): 27" x 78½"
Return top (2): 21¾" x 47"

legal width b/b/f & f/f pedestals

33322

37831

1072

HGB-84189-CDDC-GL6
overall dimension 84"D x 188¾"W x 42"H
Desk top (2): 27" x 90½"
Return top (2): 21¾" x 47"

legal width b/b/f & f/f pedestals

34725

39877

1132

option 1: straight stepped front

option 2: as shown, concave bow front

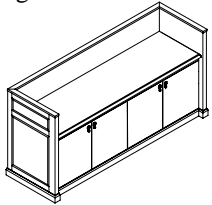
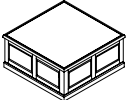
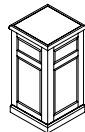
Description	Model Number	Overall Dimensions			Notes	Price (US\$)	Weight (lbs.)	
		Depth	Width	Height				
Credenza- Full Hinged Door Storage 	HC0R-2472-HHHH	24¼	72	40¾	2 bay, 4 hinged doors	8216	9561	290
	HC0R-2484-HHHH	24¼	84	40¾	2 bay, 4 hinged doors	8570	10133	309
	HC0R-2496-HHHHHH	24¼	96	40¾	3 bay, 6 hinged doors	10060	11836	348
					<u>Stand-alone Credenza only</u> option 1: no detail on back option 2: raised panels on back			
1 adjustable shelf behind each pair of hinged doors								
Occasional Table Cube 	HTC-303020	30	30	20		2585	131	
	HTC-363616	36	36	16		2738	165	
	HTC-424216	42	42	16		3117	215	
	HTC-484816	48	48	16		3519	272	
Display Stand 	HTC-181836	18	18	36		2572	83	
	HTC-181842	18	18	42		2755	92	

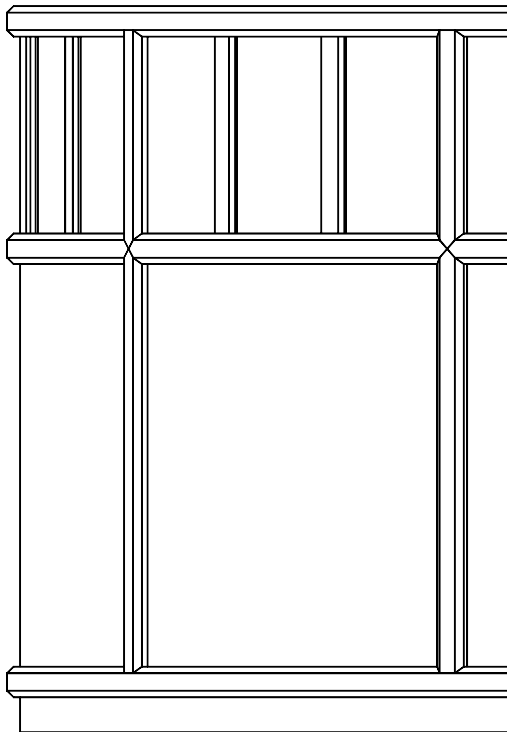

TYMPANI

Tympani consists of $\frac{1}{4}$ circle and straight segments with 42 $\frac{1}{2}$ " high gallery fronts. Detail and rhythm are developed through a pattern of applied solid wood mullion and muntin strips. An optional version is available without vertical mullion. A 3" high toekick base is recessed $\frac{3}{4}$ " and faced with black plastic laminate. Work and transaction surfaces are 1 $\frac{3}{4}$ " thick with bevel eased edges. In-line segments are not detailed on adjoining edges and connections are made via simple butt joints. Where bridge segment tops join credenza worksurfaces, the edge is interrupted and continued with an inside mitered connection. This allows a smooth transition between worksurfaces. The inside face of the vertical panels (i.e. The kneespace and "tackboard" area) is surfaced in black laminate. Black locks are standard on all drawers and are keyed alike by set-up.

Legs and aprons on occasional tables are standard w/ leather wrap. The smaller inset panels on the reception workstation may also be specified w/ leather surfaces for a nominal upcharge.

This price list allows a certain amount of flexibility with the drawer storage components. The box-box-file pedestals (6-6-12) indicated with the letters A or C and the file-file (12-12) indicated with the letters B or D are interchangeable. Within the model number, the letters after the dimensional numbers communicate the drawer configuration. These letters indicate the sequence and type of drawer storage on the unit. The A, B, C and D pedestals are interchangeable at the same price. Tympani freestanding pedestals are finished on two sides.

The overall dimensions indicated include any protrusions, overhang or thickness of detail(s). When multiple components are configured together to form large assemblies, these detail dimensions will include the elimination of conflicting or duplicated detail. Top dimensions indicated are for the net (usable) worksurface area.

Please note that pedestals are only located in straight return sections, except where noted. Due to the geometrics involved, the use of pedestals in curved sections is highly impractical in terms of seated usability,

CONFIGURATION EXAMPLES

Description

Notes

Price (US\$)
no mullions full detail

Weight (lbs.)

Gallery Desk

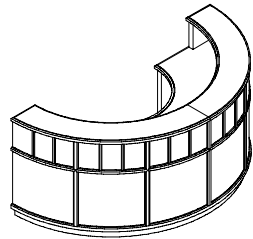

YD0RT-50100-C-GL2
overall dimension 50"D x 100"W x 42"H
Desk top: 26" depth

1 freestanding letter width
b/b/f pedestal

17995 21321 588

Gallery Desk w/ Return

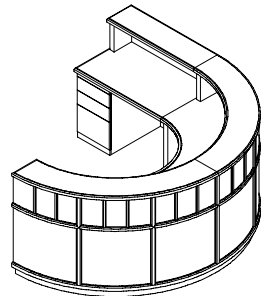

YGAL-92100-AB-GL3
overall dimension 92"D x 100"W x 42"H
Desk top: 26" depth
Return top: 26" x 42"

letter width b/b/f & f/f pedestals
both freestanding

21971 26212 741

YGAL-104100-AB-GL3
overall dimension 104"D x 100"W x 42"H
Desk top: 26" depth
Return top: 26" x 54"

letter width b/b/f & f/f pedestals
both freestanding

22335 26579 770

Specify Left or Right (seated)

(Left indicated)

Circle Configuration Rear Entry

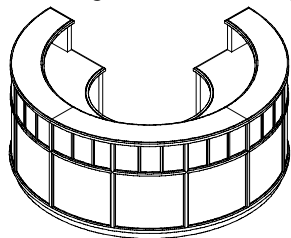

YGR-85100-GL3
overall dimension 85"D x 100"W x 42"H
Desk top: 26" depth

no pedestals

23761 28751 733

CONFIGURATION EXAMPLES

Description

Notes

Price (US\$)
no mullions full detail

Weight (lbs.)

"U" Configuration Rear Entry

YGM-92100-CD-GL4
overall dimension 92"D x 100"W x 42"H
Desk top: 26" depth
Return top (2): 26" x 42"

legal width b/b/f & f/f pedestals

24478

29634

814

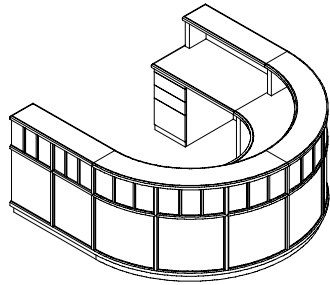

YGM-104100-CD-GL4
overall dimension 104"D x 100"W x 42"H
Desk top : 26" depth
Return top (2): 26" x 54"

legal width b/b/f & f/f pedestals

25212

30368

872

"U" Configuration Side Entry

YGCL-120100-CD-GL4
overall dimension 119"D x 100"W x 42"H
Desk top: 26" depth
Bridge top: 26" x 42"
Credenza top: 26" x 97"

legal width b/b/f & f/f pedestals
pedestals are located in the credenza

27572

32735

1026

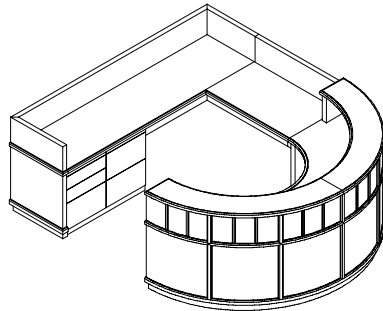

Specify **L**eft or **R**ight (seated)

(**L**eft indicated)



Above pricing reflects standard cherry and maple finishes. Consult sales representative for any variation of size, configuration, finish or wood species.

CONFIGURATION EXAMPLES

Description

Notes

Price (US\$)
no mullions full detail

Weight (lbs.)

Elongated "U"

YGM-50142-CD-GL4
overall dimension 50"D x 142"W x 42"H
Desk top: 26" x 42"
Return top (2): 26" depth

legal width b/b/f & f/f pedestals
both freestanding

22306

26550

770

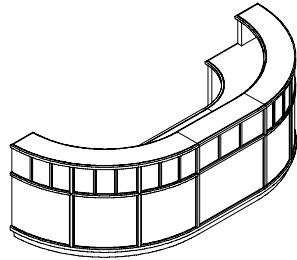

YGM-50154-CD-GL4
overall dimension 50"D x 154"W x 42"H
Desk top: 26" x 54"
Return top (2): 26" depth

legal width b/b/f & f/f pedestals
both freestanding

22673

26917

799

Description	Model Number	Overall Dimensions			Notes	Price (US\$)	Weight (lbs.)
		Depth	Width	Height			
Credenza- Full Hinged Door Storage	YC0R-28100-HHHHHH	28	100	42	3 bay, 6 hinged doors	10315	11232 433

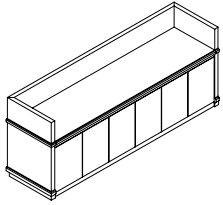

1 adjustable shelf behind each pair of hinged doors

Occasional Table w/ legs	YTS4L-363616	36	36	16		2458	65
	YTS4L-424216	42	42	16		2627	83
	YTS4L-484816	48	48	16		3219	103

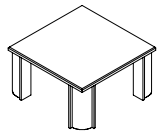

leather wrapped leg inserts, black
leather standard -COL at same price

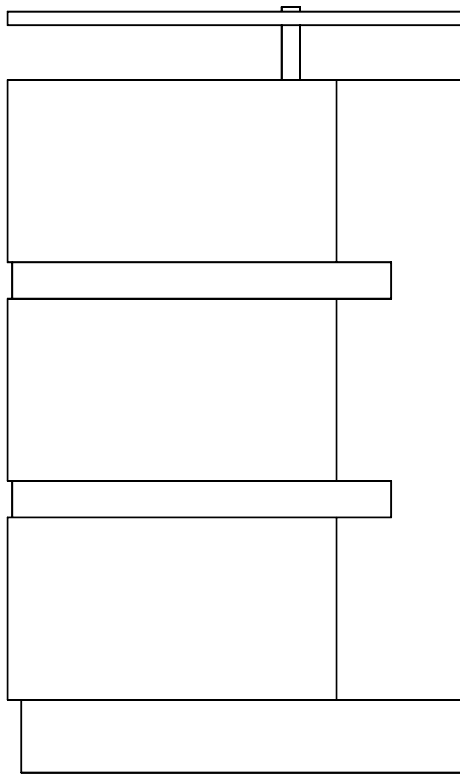

JANUS

designed by Roberta Gossett

Janus provides a bold opening statement with emphatic horizontal bands linking recessed feature panel with extended corner blocks (“quoins”). A $\frac{3}{4}$ " thick by 12" deep transaction surface is raised 3" above the wood case on $\frac{1}{4}$ " diameter stainless steel posts. Horizontal bands are 2" high, recessed $\frac{1}{2}$ " from the face of the recessed feature panel. A total of three finishes may thus be specified. Maple body/reverse box Birds Eye Maple accent front/Cherry quoins/Black banding is standard. The 12" bowtop transaction surface is standard in tempered glass but may be specified in granite at an upcharge.

Worksurfaces are $\frac{1}{4}$ " thick with a square edge. Connections between worksurfaces are made via simple butt joints. Black locks are standard on all drawers and are keyed alike by set-up.

Due to the unique detailing of this product the juncture of desk/return is disguised. See the following configuration and individual component pricing pages for further information.

This price list allows a certain amount of flexibility with the drawer storage components. The box/box/file pedestals (6-6-12) indicated with the letters A or C and the file/file (12-12) indicated with the letters B or D are interchangeable. Within the model number, the letters after the dimensional numbers communicate the drawer configuration. These letters indicate the sequence and type of drawer storage on the unit. The A, B, C and D pedestals are interchangeable at the same price.

The overall dimensions indicated throughout this price list for each item include the projection of the top detail. When components are configured together to form larger assemblies, this projected detail is eliminated but the body of the unit remains the same. Therefore the overall combined dimension of a configuration will not be the sum of the single unit's dimensions. This assures a transition between components that is tight and free of gaps. In some cases duplicated panels may be eliminated for a cleaner appearance. Contact the factory for exact dimensions if overall size of a configured unit is required.

CONFIGURATION EXAMPLES

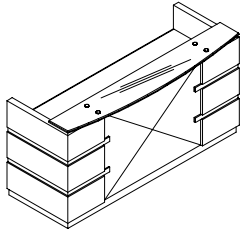
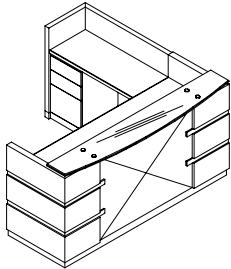
	Description	Notes	Price (US\$)	Weight (lbs.)
Gallery Desk 	JD0RA-3272-CD-GL2 overall dimension 32"D x 72"W x 43¾"H Desk top: 27½" x 67½"	legal width b/b/f & f/f pedestals	15142	485
	JD0RA-3384-CD-GL2 overall dimension 33"D x 84"W x 43¾"H Desk top: 27½" x 79½"	legal width b/b/f & f/f pedestals	16165	531
	JD0RA-3496-CD-GL2 overall dimension 34"D x 96"W x 43¾"H Desk top: 27½" x 91½"	legal width b/b/f & f/f pedestals	17191	577
Gallery Desk w/ Return 	JGAL-8072-CD-GL3 overall dimension 80"D x 72"W x 43¾"H Desk top: 27½" x 67½" Return top: 18½" x 46"	legal width b/b/f & f/f pedestals	17987	602
	JGAL-8184-CD-GL3 overall dimension 81"D x 84"W x 43¾"H Desk top: 27½" x 79½" Return top: 23½" x 46"	legal width b/b/f & f/f pedestals	19154	663
	JGAL-8296-CD-GL3 overall dimension 82"D x 96"W x 43¾"H Desk top: 27½" x 91½" Return top: 23½" x 46"	legal width b/b/f & f/f pedestals	20184	709
Specify L eft or R ight (seated)	(L eft indicated)			

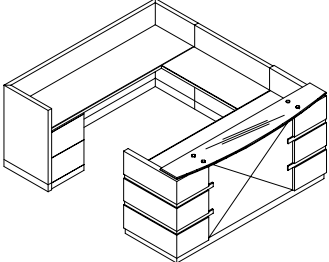
Description	Model Number	Overall Dimensions			Notes	Price (US\$)	Weight (lbs.)
		Depth	Width	Height			
"U" Configuration Side Entry 	JGCL-10472-DC-GL4	overall dimension 104"D x 72"W x 43¾"H			legal width b/b/f & f/f pedestals	21699	790
		Desk top: 27½" x 67½"					
		Bridge top: 18½" x 46"					
	JGCL-10584-DC-GL4	overall dimension 105"D x 84"W x 43¾"H			legal width b/b/f & f/f pedestals	23118	870
	Desk top: 27½" x 79½"						
	Bridge top: 23½" x 46"						
	JGCL-10696-DC-GL4	overall dimension 106"D x 96"W x 43¾"H			legal width b/b/f & f/f pedestals	24458	941
	Desk top: 27½" x 91½"						
	Bridge top: 23½" x 46"						
	Credenza top: 23½" x 91½"						

Specify **L**eft or **R**ight (seated)

(**L**eft indicated)

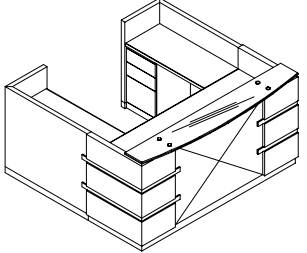
"U" Configuration Rear Entry 	JGM-8784-CD-GL4	overall dimension 87"D x 84"W x 43¾"H			legal width b/b/f & f/f pedestals	22165	789
		Return top: 18½" x 52"					
		Desk top: 27½" x 79½"					
	JGM-8896-CD-GL4	overall dimension 88"D x 96"W x 43¾"H			legal width b/b/f & f/f pedestals	23483	865
	Return top: 23½" x 52"						
	Desk top: 27½" x 91½"						
	Return top: 23½" x 52"						

CONFIGURATION EXAMPLES

Description

Notes

Price (US\$) **Weight (lbs.)**

Tandem "T" Workstation

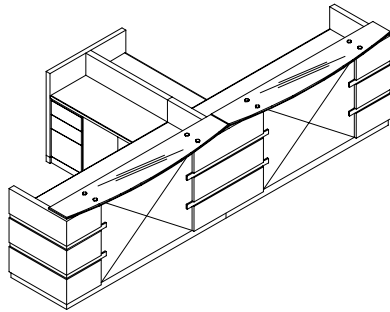

JGF-80142-DCCD-GL6
 overall dimension 80"D x 142"W x 43 ¾"H
 Desk top (2): 27½" x 67½"
 Return top (2): 18½" x 46"

legal width b/b/f & f/f pedestals

33932 1105

JGF-81166-DCCD-GL6
 overall dimension 81"D x 166"W x 43 ¾"H
 Desk top (2): 27½" x 79½"
 Return top (2): 23½" x 46"

legal width b/b/f & f/f pedestals

36226 1224

JGF-82190-DCCD-GL6
 overall dimension 82"D x 190"W x 43 ¾"H
 Desk top (2): 27½" x 91½"
 Return top (2): 23½" x 46"

legal width b/b/f & f/f pedestals

38271 1316

Tandem "U" Workstation

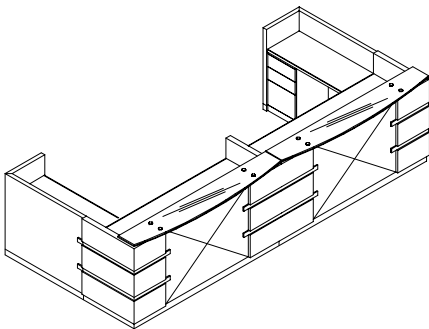

JGB-86142-CDDC-GL6
 overall dimension 86"D x 142"W x 43 ¾"H
 Desk top (2): 27½" x 67½"
 Return top (2): 18½" x 52"

legal width b/b/f & f/f pedestals

35296 1186

JGB-87166-CDDC-GL6
 overall dimension 87"D x 166"W x 43 ¾"H
 Desk top (2): 27½" x 79½"
 Return top (2): 23½" x 52"

legal width b/b/f & f/f pedestals

37620 1306

JGB-88190-CDDC-GL6
 overall dimension 88"D x 190"W x 43 ¾"H
 Desk top (2): 27½" x 91½"
 Return top (2): 23½" x 52"

legal width b/b/f & f/f pedestals

39665 1398

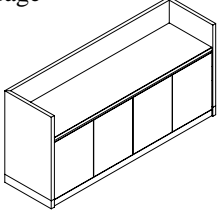
Description	Model Number	Overall Dimensions			Notes	Price (US\$)	Weight (lbs.)
		Depth	Width	Height			
Credenza Full Hinged Door Storage 	JC0R-2672-HHHH	26	72	40	2 bay, 4 hinged doors	6961	333
	JC0R-2684-HHHH	26	84	40	2 bay, 4 hinged doors	7276	358
	JC0R-2696-HHHHHH	26	96	40	3 bay, 6 hinged doors	8719	403

1 adjustable shelf behind each pair of hinged doors

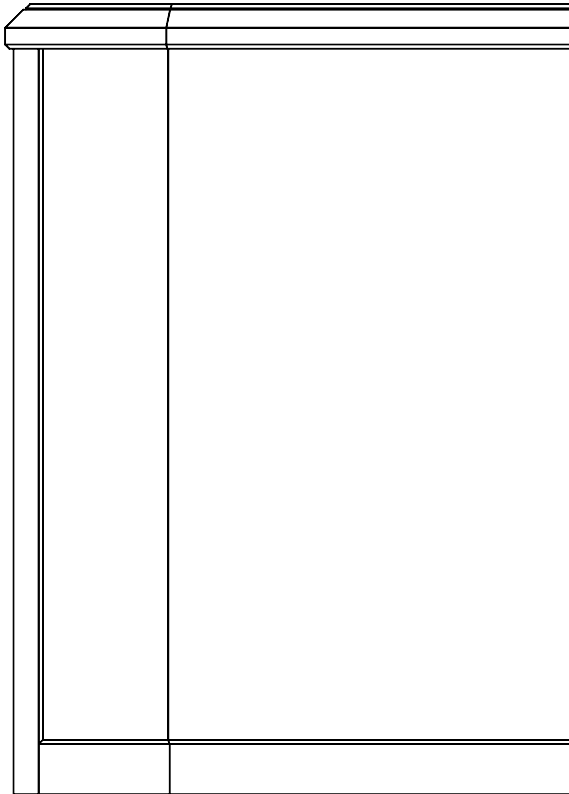

TOCOTTA

designed by Don Killaby

Tocotta is a unique combination of design elements that enables the use of different finishes and surface materials to create a product statement of tremendous range. The 2" thick stepped beveled top edge allows within the break of the bevels the first opportunity for material or color contrast. The ¼" raised section of the worksurface is identified as the top element. The edges on all worksurfaces, tables and tops are all mitered. Where adjoining surfaces with the edge profile meet, the edge is interrupted and an inside miter joint provides a continuous transition.

The other design elements that provide for contrast are the recessed 2¼" plinth base and the vertical corner pilaster which is a ⅝" radius column. These components, along with the finish on the drawer interiors, are identified as the trim of the unit and are constructed with solid wood.

The body of the Tocotta unit is the vertical panels that form the pedestals, the surrounds, and the door and drawer fronts. These panels have subtle ⅜" bevels on their edges. The upper storage components are 1¼" profile with the same ⅜" bevel. Drawers are opened with recessed side finger access. The hinged doors have touch latch hardware or bottom edge access where possible. Necessary exposed hardware is used on lateral file drawers. Black locks are standard on all drawers and are keyed alike by set-up.

This price list allows a certain amount of flexibility with the drawer storage components. The box/box/file pedestals (6-6-12) indicated with the letters A or C and the file/file (12-12) indicated with the letters B or D are interchangeable. Within the model number, the letters after the dimensional numbers communicate the drawer configuration. These letters indicate the sequence and type of drawer storage on the unit. The A, B, C and D pedestals are interchangeable at the same price. All configurations illustrated include one C and one D pedestal.

The overall dimensions indicated include any protrusions, overhang or thickness of detail(s). When multiple components are configured together to form large assemblies, these detail dimensions will include the elimination of conflicting or duplicated detail. Top dimensions indicated are for the net (usable) worksurface area.

For more specific information on Tocotta and how to order or specify, please refer to the separate Tocotta price list.

CONFIGURATION EXAMPLES

	Description	Notes	Price (US\$)	Weight (lbs.)
Gallery Desk	TDFRT-3672-CD-GL2 overall dimension 36"D x 72 ¾"W x 43"H Desk top: 28" x 68"	legal width b/b/f & f/f pedestals	13718	623
	TDFRT-3784-CD-GL2 overall dimension 36¾"D x 84"W x 43"H Desk top: 28" x 80"	legal width b/b/f & f/f pedestals	14595	667
	TDFRT-3896-CD-GL2 overall dimension 37⅜"D x 96¾"W x 43"H Desk top: 28" x 92"	legal width b/b/f & f/f pedestals	15486	711
Gallery Desk w/ Return	TGAL-7872-CD-GL3 overall dimension 78"D x 72¾"W x 43"H Desk top: 28" x 68" Return top: 22" x 40"	legal width b/b/f & f/f pedestals	17191	732
	TGAL-7984-CD-GL3 overall dimension 78¾"D x 84¾"W x 43"H Desk top: 28" x 80" Return top: 22" x 40"	legal width b/b/f & f/f pedestals	18068	776
	TGAL-7996-CD-GL3 overall dimension 79⅝"D x 96¾"W x 43"H Desk top: 28" x 92" Return top: 22" x 40"	legal width b/b/f & f/f pedestals	18958	820
Specify L eft or R ight (seated)	(L eft indicated)			

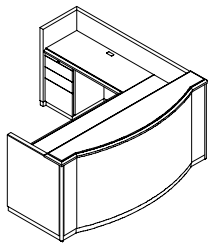
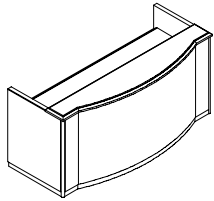

CONFIGURATION EXAMPLES

Description

Notes

**Price
(US\$)**

**Weight
(lbs.)**

"U" Configuration Side Entry

TGCL-10472-DC-GL4
 overall dimension 104"D x 72¾"W x 43"H
 Desk top: 28" x 68"
 Bridge top: 22" x 42"
 Credenza top: 24" x 68"

legal width b/b/f & f/f pedestals

22042

906

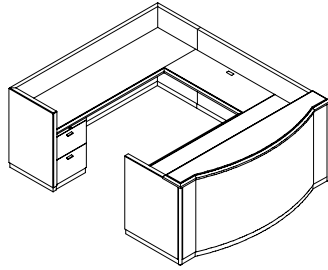

TGCL-10584-DC-GL4
 overall dimension 104¾"D x 84¾"W x 43"H
 Desk top: 28" x 80"
 Bridge top: 22" x 42"
 Credenza top: 24" x 80"

legal width b/b/f & f/f pedestals

23517

973

TGCL-10596-DC-GL4
 overall dimension 105⅞"D x 96¾"W x 43"H
 Desk top: 28" x 92"
 Bridge top: 22" x 42"
 Credenza top: 24" x 92"

legal width b/b/f & f/f pedestals

24746

1041

Specify **L**eft or **R**ight (seated)

(**L**eft indicated)

"U" Configuration Rear Entry

TGM-7984-CD-GL4
 overall dimension 78¾"D x 84¾"W x 43"H
 Return top: 22" x 40"
 Desk top: 28" x 80"
 Return top: 22" x 40"

legal width b/b/f & f/f pedestals

21540

885

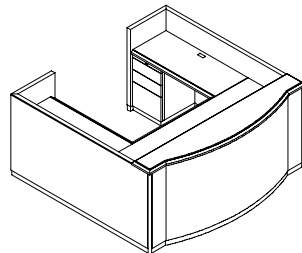

TGM-7996-CD-GL4
 overall dimension 79⅞"D x 96¾"W x 43"H
 Return top: 22" x 40"
 Desk top: 28" x 92"
 Return top: 22" x 40"

legal width b/b/f & f/f pedestals

22430

929

CONFIGURATION EXAMPLES

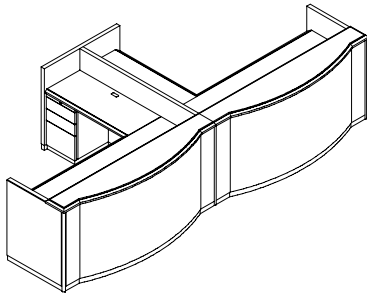
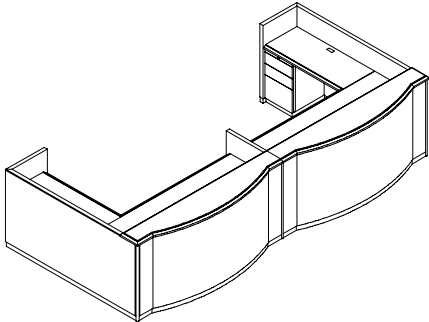
	Description	Notes	Price (US\$)	Weight (lbs.)
<p>Tandem "T" Workstation</p> 	<p>TGF-78142-DCCD-GL6 overall dimension 78"D x 142"W x 43"H Desk top (2): 28" x 68" Return top (2): 22" x 40"</p>	legal width b/b/f & f/f pedestals	33262	1370
	<p>TGF-79166-DCCD-GL6 overall dimension 78¾"D x 166"W x 43"H Desk top (2): 28" x 80" Return top (2): 22" x 40"</p>	legal width b/b/f & f/f pedestals	35016	1458
	<p>TGF-79190-DCCD-GL6 overall dimension 79⅞"D x 190"W x 43"H Desk top (2): 28" x 92" Return top (2): 22" x 40"</p>	legal width b/b/f & f/f pedestals	36796	1546
<p>Tandem "U" Workstation</p> 	<p>TGB-78142-CDDC-GL6 overall dimension 78"D x 142"W x 43"H Desk top (2): 28" x 66" Return top (2): 22" x 40"</p>	legal width b/b/f & f/f pedestals	33738	1422
	<p>TGB-79166-CDDC-GL6 overall dimension 78¾"D x 166"W x 43"H Desk top (2): 28" x 80" Return top (2): 22" x 40"</p>	legal width b/b/f & f/f pedestals	35492	1510
	<p>TGB-79190-CDDC-GL6 overall dimension 79⅞"D x 190"W x 43"H Desk top (2): 28" x 92" Return top (2): 22" x 40"</p>	legal width b/b/f & f/f pedestals	37272	1598

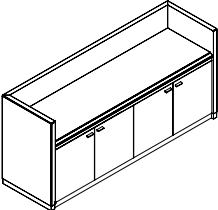
Description	Model Number	Overall Dimensions			Notes	Price (US\$)	Weight (lbs.)
		Depth	Width	Height			
	TC0R-2672-HHHH	26	72	41¼	2 bay, 4 hinged doors	8198	324
	TC0R-2684-HHHH	26	84	41¼	2 bay, 4 hinged doors	8796	347
	TC0R-2696-HHHHHH	26	96	41¼	3 bay, 6 hinged doors	10262	391

1 adjustable shelf behind each pair of doors

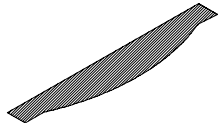
	ATTG-1470	14	70	¾	72" black granite transaction top upgrade	2639	42
	ATTG-1482	14	82	¾	84" black granite transaction top upgrade	3082	49
	ATTG-1494	14	94	¾	96" black granite transaction top upgrade	3524	56
	ATT6-1470	14	70	¾	72" birdseye maple transaction top upgrade	1025	
	ATT6-1482	14	82	¾	84" birdseye maple transaction top upgrade	1199	
	ATT6-1494	14	94	¾	96" birdseye maple transaction top upgrade	1574	
	ATTL-1470	14	70	¾	72" black leather transaction top upgrade	458	
	ATTL-1482	14	82	¾	84" black leather transaction top upgrade	516	
	ATTL-1494	14	94	¾	96" black leather transaction top upgrade	574	

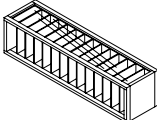
	AMC	30	3¼	3¼	glass top, plexiglass dividers	1017	10
---	-----	----	----	----	--------------------------------	------	----

Refer to separate CCN Tocotta pricelist for complete line of matching tables, casegoods etc.

T O C O T T A

Above pricing reflects standard cherry and maple finishes. Consult sales representative for any variation of size, configuration, finish or wood species.

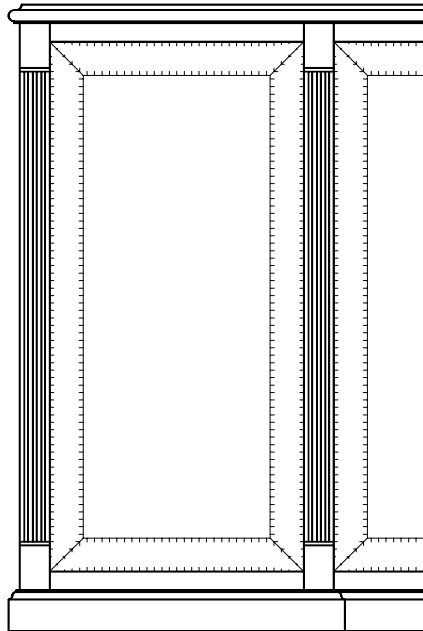
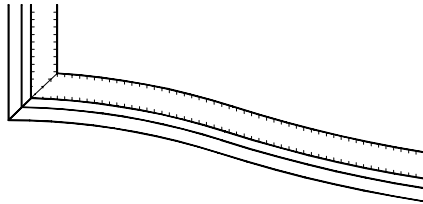

BARRINGTON LE

Barrington *LE* is an enhanced version of Barrington that introduces accent borders of quartered figured limba on primary panels throughout the product offering. This border provides a subtle contrast placed in between the plain sliced bookmatched cherry infield and the traditionally detailed solid wood trim. The standard configuration of these borders is determined by the locations of the vertical pilaster details. Typically there will be one border pattern within the space established by the vertical pilasters. The Barrington *LE* reception desk has a mitered 2¼" short grain border on the front approach panels and mitered 1¾" short grain border on the transaction tops. The reception desk worksurfaces, reception desk drawer fronts and the pilastered table bases **DO NOT** have the short grain border pattern included in the price. The Barrington *LE* price column reflects the borders as located in the above descriptions. If a different application of the accent border is required than what is outlined in this pricelist, please contact the factory to discuss the desired placement of the borders and the corresponding price, whether on the tops or vertical panels.

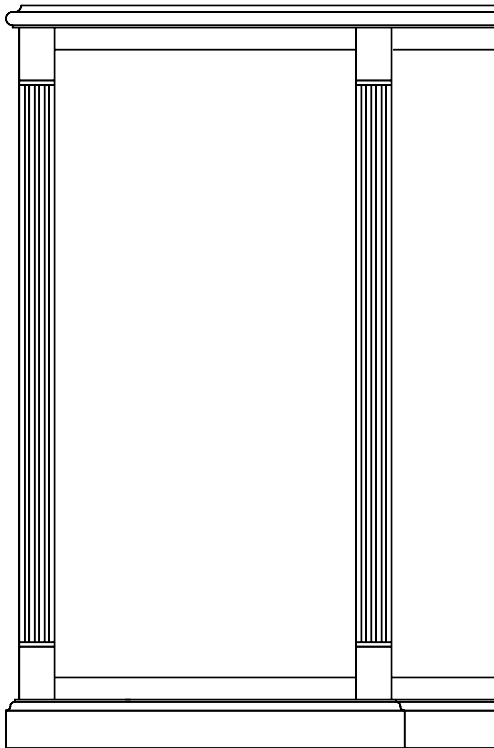

BARRINGTON

Barrington is a traditionally trimmed and detailed product design. The worksurface is 1¼" thick with a reverse ogee edge, supported by a detailed pedestal with 2¾" mitered plinth base. All edges are mitered in the corners. Where return and bridge tops join a desk and credenza worksurface, the edge is interrupted and continued with an inside mitered connection. This allows a smooth transition between worksurfaces. A stepped and fluted stile trims the vertical elements on the approach of the desk, the end panels of door and drawer units, and the vertical panels on upper storage components. The tops of high-rise storage units and anchors have a 3" crown molding to complete the traditional detailing. The approach side of the desk has a stepped modesty panel, and the back of credenzas and storage units are flush, finished and do not include the base detail. The finish on the pulls is bright brass. Black locks are standard on all drawers and are keyed alike by set-up.

This price list allows a certain amount of flexibility with the drawer storage components. The box/box/file pedestals (6- 6-12) indicated with the letters A or C and the file/file (12-12) indicated with the letters B or D are interchangeable. Within the model number, the letters after the dimensional numbers communicate the drawer configuration. These letters indicate the sequence and type of drawer storage on the unit. The A, B, C and D pedestals are interchangeable at the same price.

The overall dimensions indicated throughout this price list for each item include the projection of the edge and crown molding details. When components are configured together to form larger assemblies, this projected detail is eliminated and in some cases panels are added or eliminated, but the body of the unit remains the same. Therefore the overall combined dimension of a configuration will not be the sum of the single unit's dimensions. This assures a transition between components that is tight and free of gaps. In some cases, duplicated detail or panels may be eliminated for a cleaner appearance. Contact the factory for exact dimensions if overall size of a configured unit is required.

CONFIGURATION EXAMPLES

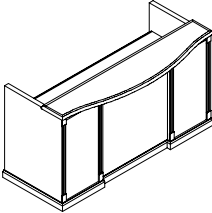
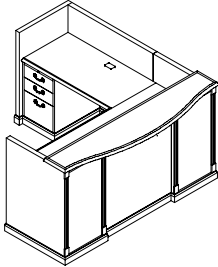
	Description	Notes	Price (US\$)		Weight (lbs.)
			Standard	LE	
Gallery Desk 	GD0RTT-3572-CD-GL2 overall dimension 35¼"D x 72"W x 42½"H Desk top: 27" x 66"	legal width b/b/f & f/f pedestals	9402	11244	473
	GD0RTT-3784-CD-GL2 overall dimension 36¾"D x 84"W x 42½"H Desk top: 27" x 78"	legal width b/b/f & f/f pedestals	9860	11941	521
	GD0RTT-3896-CD-GL2 overall dimension 38"D x 96"W x 42½"H Desk top: 27" x 90"	legal width b/b/f & f/f pedestals	10275	12592	565
			<i>LE includes 2¼" Limba short grain border on approach front panels with 1¾" Limba short grain border on transaction top</i>		
Gallery Desk w/ Return 	GGAL-7772-CD-GL3 overall dimension 77¼"D x 72"W x 42½"H Desk top: 27" x 66" Return top: 22" x 40"	legal width b/b/f & f/f pedestals	12410	14250	589
	GGAL-7984-CD-GL3 overall dimension 78¾"D x 84"W x 42½"H Desk top: 27" x 78" Return top: 22" x 40"	legal width b/b/f & f/f pedestals	12866	14947	637
	GGAL-8096-CD-GL3 overall dimension 80"D x 96"W x 42½"H Desk top: 27" x 90" Return top: 22" x 40"	legal width b/b/f & f/f pedestals	13281	15600	681
			<i>LE includes 2¼" Limba short grain border on approach front panels with 1¾" Limba short grain border on transaction top</i>		
Specify Left or Right (seated)	(Left indicated)				

CONFIGURATION EXAMPLES

Description

Notes

Price (US\$)
Standard *LE*

Weight (lbs.)

"U" Configuration Side Entry

GGCL-10572-DC-GL4
overall dimension 105¼"D x 72"W x 42½"H
Desk top: 27" x 66"
Bridge top: 22" x 42"
Credenza top: 26" x 66"

legal width b/b/f & f/f pedestals

16462

18302

786

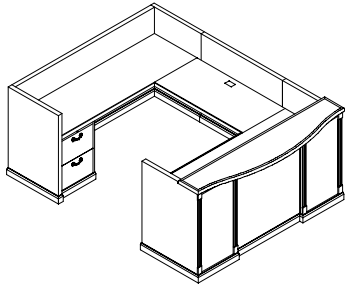

GGCL-10784-DC-GL4
overall dimension 106¾"D x 84"W x 42½"H
Desk top: 27" x 78"
Bridge top: 22" x 42"
Credenza top: 26" x 78"

legal width b/b/f & f/f pedestals

17257

19338

860

GGCL-10896-DC-GL4
overall dimension 108"D x 96"W x 42½"H
Desk top: 27" x 90"
Bridge top: 22" x 42"
Credenza top: 26" x 90"

legal width b/b/f & f/f pedestals

18011

20330

930

Specify **Left** or **Right** (seated)

(**L**eft indicated)

LE includes 2¼" Limba short grain border on approach front panels with 1¾" Limba short grain border on transaction top

"U" Configuration Rear Entry

GGM-7984-CD-GL4
overall dimension 78¾"D x 84"W x 42½"H
Return top: 22" x 40"
Desk top: 27" x 78"
Return top: 22" x 40"

legal width b/b/f & f/f pedestals

15875

17953

753

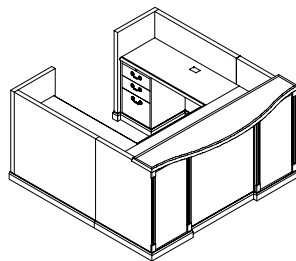

GGM-8096-CD-GL4
overall dimension 80"D x 96"W x 42½"H
Return top: 22" x 40"
Desk top: 27" x 90"
Return top: 22" x 40"

legal width b/b/f & f/f pedestals

16287

18606

797

LE includes 2¼" Limba short grain border on approach front panels with 1¾" Limba short grain border on transaction top

CONFIGURATION EXAMPLES

Description

Notes

Price (US\$)
Standard *LE*

**Weight
(lbs.)**

Tandem "T" Workstation

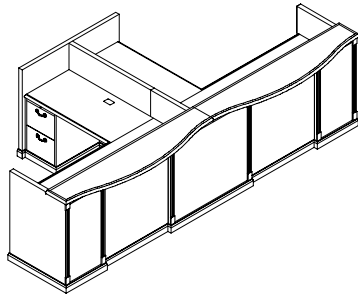

GGF-77144-CDDC-GL6
 overall dimension 77¼"D x 144"W x 42½"H
 Desk top (2): 27" x 68½"
 Return top (2): 22" x 40"

legal width b/b/f & f/f pedestals

22744

26424

1081

GGF-79168-CDDC-GL6
 overall dimension 78¾"D x 168"W x 42½"H
 Desk top (2): 27" x 80¼"
 Return top (2): 22" x 40"

legal width b/b/f & f/f pedestals

23632

27791

1175

GGF-80192-CDDC-GL6
 overall dimension 80"D x 192"W x 42½"H
 Desk top (2): 27" x 92¼"
 Return top (2): 22" x 40"

legal width b/b/f & f/f pedestals

24447

29084

1261

LE includes 2¼" Limba short grain border on approach front panels with 1¾" Limba short grain border on transaction top

Tandem "U" Workstation

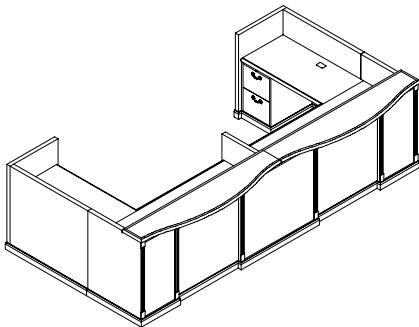

GGB-77144-DCCD-GL6
 overall dimension 77¼"D x 144"W x 42½"H
 Desk top (2): 27" x 68¼"
 Return top (2): 22" x 40"

legal width b/b/f & f/f pedestals

23804

27484

1133

GGB-79168-DCCD-GL6
 overall dimension 78¾"D x 168"W x 42½"H
 Desk top (2): 27" x 80¼"
 Return top (2): 22" x 40"

legal width b/b/f & f/f pedestals

24692

28851

1227

GGB-80192-DCCD-GL6
 overall dimension 80"D x 96"W x 42½"H
 Desk top (2): 27" x 92¼"
 Return top (2): 22" x 40"

legal width b/b/f & f/f pedestals

25507

30144

1313

LE includes 2¼" Limba short grain border on approach front panels with 1¾" Limba short grain border on transaction top

CONFIGURATION EXAMPLES

Description

Notes

Price (US\$)
Standard £€

Weight
(lbs.)

Credenza Full Hinged Door Storage

GC0R-2872-HHHH

28 72 40½

2 bay, 4 hinged doors

7396 7396

347

GC0R-2884-HHHH

28 84 40½

2 bay, 4 hinged doors

7736 7736

373

GC0R-2896-HHHHHH

28 96 40½

3 bay, 6 hinged doors

9203 9203

419

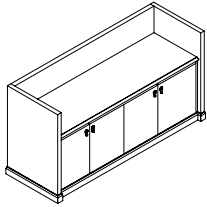

1 adjustable shelf behind each pair of hinged doors

Refer to separate CCN Barrington pricelist for complete line of matching tables, casegoods etc.

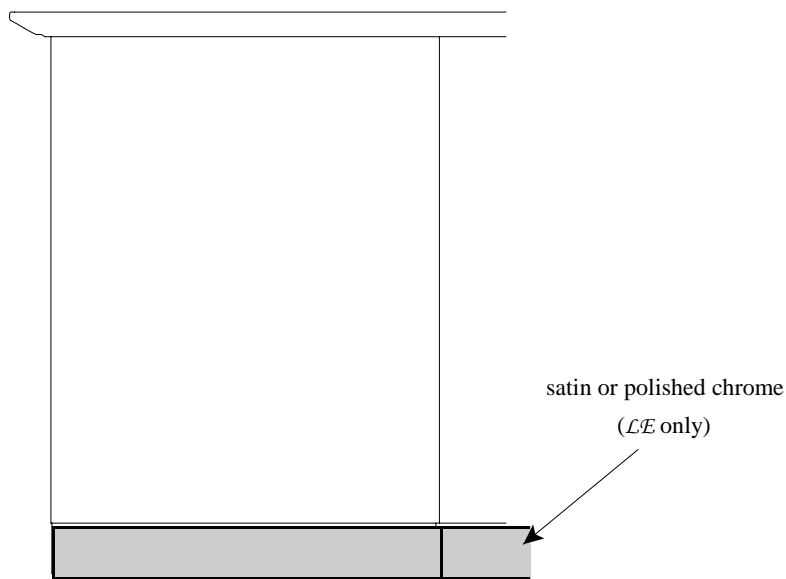
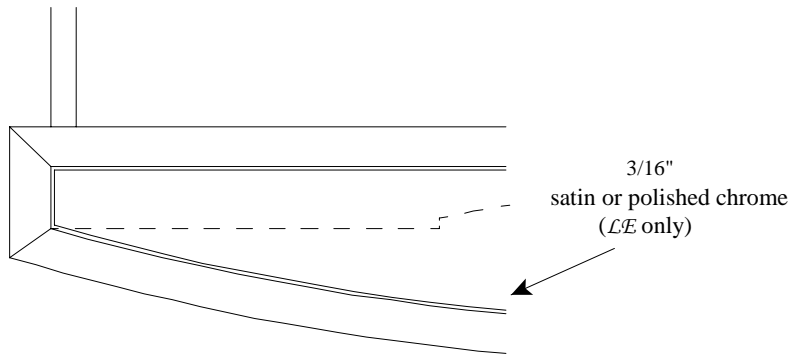

Charisma Stepped Modesty

CHARISMA

Charisma is a contemporary design that features a 1¼" cantilevered edge that projects 2". The top of the edge is flush with the worksurface and softened with a ¼" radius. The bottom of the edge is a gentle elliptical shape that forms the knife edge. This knife edge is mitered in all corners. Where return and bridge tops join desk and credenza worksurfaces, the edge is interrupted and continued with an inside mitered connection. The tops are supported by square cornered pedestals with a flush 2¾" high mitered hardwood base. This horizontal base is separated from the vertical side panel with an ⅛" recessed reveal. Where a pedestal is not present, there are vertical support panels that are 1¼" thick with square edges. The approach side of the desk has a stepped modesty panel, which allows visitor pull-up. The backs of credenzas are flush, finished and do not include the base detail. The finish on the pulls is polished chrome, or satin black. Black locks are standard on all drawers and are keyed alike by set-up.

This price list allows a certain amount of flexibility with the drawer storage components. The box-box-file pedestals (6-6-12) indicated with the letter A or C and the file-file (12-12) indicated with the letter B or D are interchangeable. Within the model number, the letters after the dimensional numbers communicate the drawer configuration. These letters indicate the sequence and type of drawer storage on the unit. The A, B, C and D pedestals are interchangeable at the same price. All configurations illustrated include one C and one D pedestal.

The overall dimensions indicated include any protrusion, overhang or thickness of detail(s). When multiple components are configured together to form larger assemblies, these detail dimensions will include the elimination of conflicting or duplicated detail. Top dimensions indicated are for the net (usable) worksurface area

As illustrated at left and below, Charisma gallery desks are available in either of two configurations: with a Column End or Stepped Modesty on the approach side. The Column End features a 8¾" diameter tall cylinder at each end and a recessed straight modesty panel between. The Stepped Modesty substitutes a broad flat panel for the ends with a concave bow modesty that is contrasted by a convex bow transaction top.

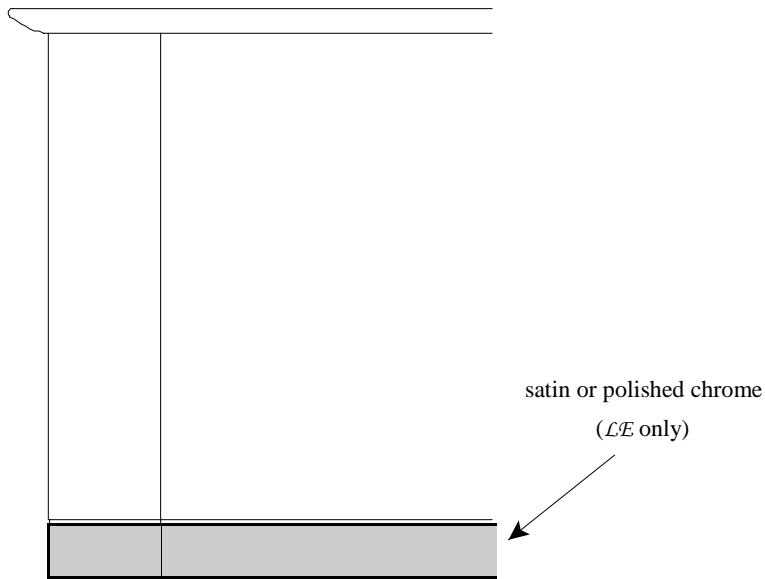
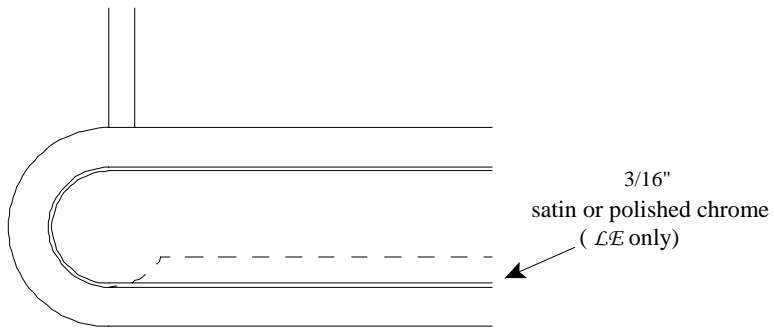

Charisma Column End

CHARISMA LE

Charisma **LE** is an enhanced version of Charisma that incorporates the use of satin or polished chrome accents. The satin or polished chrome finish on the 2½" high plinth bases allow the lower components to float above the floor. This base accent is applied to all Charisma **LE** products. Matching satin or polished chrome transaction top inlays are 3/16" wide and separate the 2" cantilevered edge from the veneer infield. The inlay creates an opportunity to select an optional veneer top of Birdseye Maple, Quartered Figured Anigre or Laurel Burl. Contact factory for pricing on the accent veneer tops.

Charisma **LE** also includes satin or polished chrome enhanced door and drawer hardware. A matching 6" wide bowed handle will be used on reception station door and drawer storage components. The lock plugs on the Charisma **LE** product match the satin or polished chrome finish of the metal accents. Optional wire exit grommets are available in separate Accessories price list, in matching metal finishes.

CONFIGURATION EXAMPLES

	Description	Notes	Price (US\$)		Weight (lbs.)
			Standard	LE	
Column Corner Gallery Desk	CDCRTR-3484-CD-GL2 overall dimension 33½"D x 84"W x 42½"H Desk top: 26" x 69½"	legal width b/b/f & f/f pedestals	9595	10799	509
	CDCRTR-3496-CD-GL2 overall dimension 33½"D x 96"W x 42½"H Desk top: 26" x 81½"	legal width b/b/f & f/f pedestals	9917	11228	544
<i>LE includes 2½"h chrome base, 3/16" chrome transaction top inlay & enhanced chrome access hardware</i>					
Column Corner Gallery Desk w/ Return	CGALC-7684-CD-GL3 overall dimension 75½"D x 84"W x 42½"H Desk top: 26" x 69½" Return top: 22½" x 40¾"	legal width b/b/f & f/f pedestals	12585	13908	625
	CGALC-7696-CD-GL3 overall dimension 75½"D x 96"W x 42½"H Desk top: 26" x 81½" Return top: 22½" x 40¾"	legal width b/b/f & f/f pedestals	120906	14340	660
<i>LE includes 2½"h chrome base, 3/16" chrome transaction top inlay & enhanced chrome access hardware</i>					
Specify Left or Right (seated)	(Left indicated)				

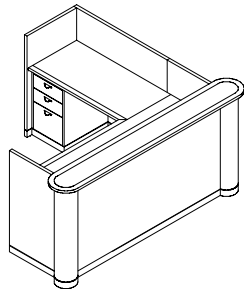
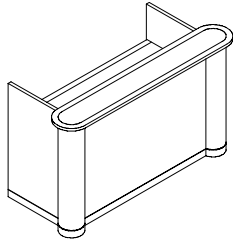

CONFIGURATION EXAMPLES

Description

Notes

Price (US\$)
Standard LE

Weight (lbs.)

Column Corner
 "U" Configuration Side Entry

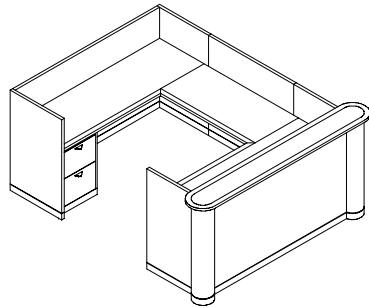

CGCLC-9884-DC-GL4
 overall dimension 97½"D x 84"W x 42½"H
 Desk top: 26" x 69½"
 Bridge top: 22¾" x 42"
 Credenza top: 20½" x 69½"

legal width b/b/f & f/f pedestals

16332 17848

792

CGCLC-9896-DC-GL4
 overall dimension 97½"D x 96"W x 42½"H
 Desk top: 26" x 81½"
 Bridge top: 22¾" x 42"
 Credenza top: 20½" x 81½"

legal width b/b/f & f/f pedestals

16978 18638

851

Specify Left or Right (seated)

(Left indicated)

LE includes 2½"h chrome base, 3/16" chrome transaction top inlay & enhanced chrome access hardware

Column Corner
 "U" Configuration Rear Entry

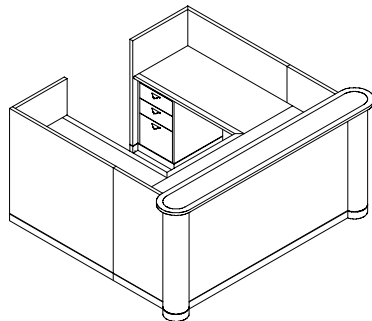

CGM0C-7684-CD-GL4
 overall dimension 75½"D x 84"W x 42½"H
 Return top: 22½" x 40¾"
 Desk top: 26" x 69½"
 Return top: 22½" x 40¾"

legal width b/b/f & f/f pedestals

15575 17017

741

CGM0C-7696-CD-GL4
 overall dimension 75½"D x 96"W x 42½"H
 Return top: 22½" x 40¾"
 Desk top: 26" x 81½"
 Return top: 22½" x 40¾"

legal width b/b/f & f/f pedestals

15896 17448

776

LE includes 2½"h chrome base, 3/16" chrome transaction top inlay & enhanced chrome access hardware

CONFIGURATION EXAMPLES

Description

Notes

Price (US\$)
Standard LE

Weight (lbs.)

Column Corner
 Tandem "T" Workstation

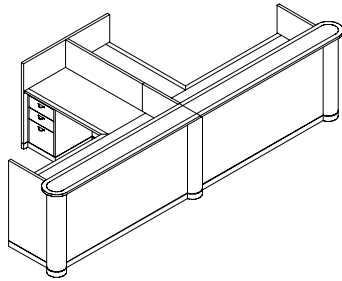

CGF0C-76156-DCCD-GL6
 overall dimension 75½"D x 156"W x 42½"H
 Desk top (2): 26" x 69½"
 Return top (2): 22½" x 40¾"

legal width b/b/f & f/f pedestals

22678

25326

1145

CGF0C-76180-DCCD-GL6
 overall dimension 75½"D x 180"W x 42½"H
 Desk top (2): 26" x 81½"
 Return top (2): 22½" x 40¾"

legal width b/b/f & f/f pedestals

23321

26189

1214

LE includes 2½"h chrome base, 3/16" chrome transaction top inlay & enhanced chrome access hardware

Column Corner
 Tandem "U" Workstation

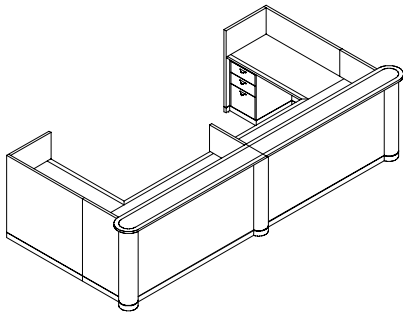

CGB0C-76156-CDDC-GL6
 overall dimension 75½"D x 156"W x 42½"H
 Desk top (2): 26" x 69½"
 Return top (2): 22½" x 40¾"

legal width b/b/f & f/f pedestals

23722

26370

1197

CGB0C-76180-CDDC-GL6
 overall dimension 75½"D x 180"W x 42½"H
 Desk top (2): 26" x 81½"
 Return top (2): 22½" x 40¾"

legal width b/b/f & f/f pedestals

24365

27233

1266

LE includes 2½"h chrome base, 3/16" chrome transaction top inlay & enhanced chrome access hardware

CONFIGURATION EXAMPLES

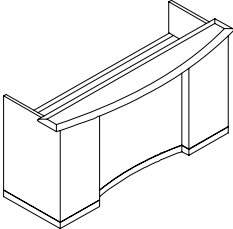
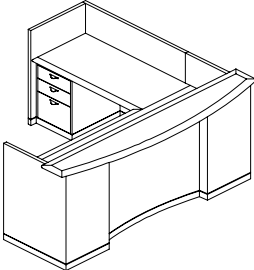
	Description	Notes	Price (US\$)		Weight (lbs.)
			Standard	LE	
Concave Stepped Modesty Gallery Desk 	CDDRTF-3572-CD-GL2 overall dimension 34½"D x 72"W x 42½"H Desk top: 24" x 65½"	legal width b/b/f & f/f pedestals	9306	10402	516
	CDDRTF-3584-CD-GL2 overall dimension 34½"D x 84"W x 42½"H Desk top: 24" x 77½"	legal width b/b/f & f/f pedestals	9669	10877	560
	CDDRTF-3596-CD-GL2 overall dimension 34½"D x 96"W x 42½"H Desk top: 24" x 89½"	legal width b/b/f & f/f pedestals	10034	11350	605
LE includes 2½"h chrome base, 3/16" chrome transaction top inlay & enhanced chrome access hardware					
Concave Stepped Modesty Gallery Desk w/ Return 	CGALD-7772-CD-GL3 overall dimension 76½"D x 72"W x 42½"H Desk top: 24" x 65½" Return top: 22½" x 40¾"	legal width b/b/f & f/f pedestals	12292	13512	632
	CGALD-7784-CD-GL3 overall dimension 76½"D x 84"W x 42½"H Desk top: 24" x 77½" Return top: 22½" x 40¾"	legal width b/b/f & f/f pedestals	12659	13985	676
	CGALD-7796-CD-GL3 overall dimension 76½"D x 96"W x 42½"H Desk top: 24" x 89½" Return top: 22½" x 40¾"	legal width b/b/f & f/f pedestals	13022	14458	721
LE includes 2½"h chrome base, 3/16" chrome transaction top inlay & enhanced chrome access hardware					
Specify Left or R ight (seated)	(L eft indicated)				

CONFIGURATION EXAMPLES

Description

Notes

Price (US\$)
Standard *LE*

Weight (lbs.)

Concave Stepped Modesty
"U" Configuration Side Entry

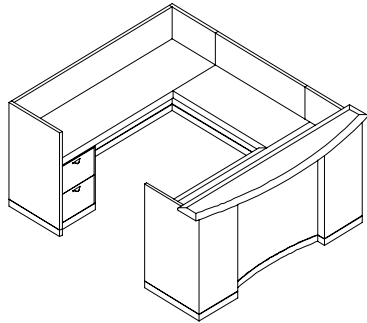

CGCLD-9972-DC-GL4
overall dimension 98½"D x 72"W x 42½"H
Desk top: 24" x 65½"
Bridge top: 22¾" x 42"
Credenza top: 20½" x 65½"

legal width b/b/f & f/f pedestals

16039 174452

799

CGCLD-9984-DC-GL4
overall dimension 98½"D x 84"W x 42½"H
Desk top: 24" x 77½"
Bridge top: 22¾" x 42"
Credenza top: 20½" x 77½"

legal width b/b/f & f/f pedestals

16731 18283

867

CGCLD-9996-DC-GL4
overall dimension 98½"D x 96"W x 42½"H
Desk top: 24" x 89½"
Bridge top: 22¾" x 42"
Credenza top: 20½" x 89½"

legal width b/b/f & f/f pedestals

17421 19114

936

LE includes 2½" h chrome base, 3/16" chrome transaction top inlay & enhanced chrome access hardware

Specify Left or Right (seated)

(Left indicated)

Concave Stepped Modesty
"U" Configuration Rear Entry

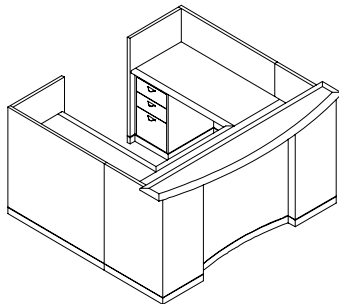

CGB0D-7784-CD-GL4
overall dimension 76½"D x 84"W x 42½"H
Return top: 22½" x 40¾"
Desk top: 24" x 77½"
Return top: 22½" x 40¾"

legal width b/b/f & f/f pedestals

15646 17092

792

CGB0D-7796-CD-GL4
overall dimension 76½"D x 96"W x 42½"H
Return top: 22½" x 40¾"
Desk top: 24" x 89½"
Return top: 22½" x 40¾"

legal width b/b/f & f/f pedestals

16011 17564

837

LE includes 2½" h chrome base, 3/16" chrome transaction top inlay & enhanced chrome access hardware

CONFIGURATION EXAMPLES

Description

Notes

Price (US\$)
Standard LE

Weight (lbs.)

Concave Stepped Modesty
 Tandem "T" Workstation

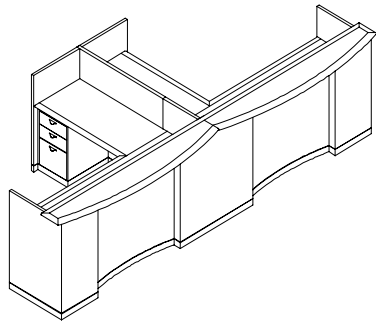

CGF0D-77143-DCCD-GL6
 overall dimension 76½"D x 142¾"W x 42½"H
 Desk top (2): 24" x 65½"
 Return top (2): 22½" x 40¾"

legal width b/b/f & f/f pedestals

22542

24964

1167

CGF0D-77167-DCCD-GL6
 overall dimension 76½"D x 166¾"W x 42½"H
 Desk top (2): 24" x 77½"
 Return top (2): 22½" x 40¾"

legal width b/b/f & f/f pedestals

23259

25910

1255

CGF0D-77191-DCCD-GL6
 overall dimension 76½"D x 190¾"W x 42½"H
 Desk top (2): 24" x 89½"
 Return top (2): 22½" x 40¾"

legal width b/b/f & f/f pedestals

23984

26856

1345

LE includes 2½"h chrome base, 3/16" chrome transaction top inlay & enhanced chrome access hardware

Concave Stepped Modesty
 Tandem "T" Workstation

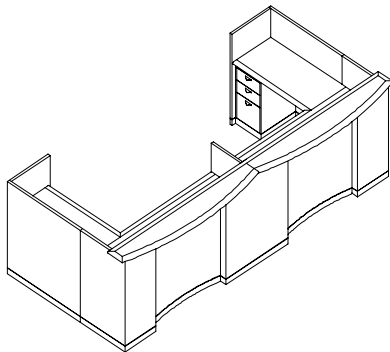

CGB0D-77143-CDDC-GL6
 overall dimension 76½"D x 142¾"W x 42½"H
 Desk top (2): 24" x 65½"
 Return top (2): 22½" x 40¾"

legal width b/b/f & f/f pedestals

23568

26008

1219

CGB0D-77167-CDDC-GL6
 overall dimension 76½"D x 166¾"W x 42½"H
 Desk top (2): 24" x 77½"
 Return top (2): 22½" x 40¾"

legal width b/b/f & f/f pedestals

24303

26954

1307

CGB0D-77191-CDDC-GL6
 overall dimension 76½"D x 190¾"W x 42½"H
 Desk top (2): 24" x 89½"
 Return top(2): 22½" x 40¾"

legal width b/b/f & f/f pedestals

25028

27900

1397

LE includes 2½"h chrome base, 3/16" chrome transaction top inlay & enhanced chrome access hardware

CONFIGURATION EXAMPLES

Description

Notes

Price (US\$)
Standard *LE*

**Weight
(lbs.)**

Credenza- Full Hinged Door
 Storage

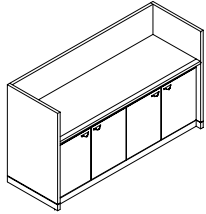

CC0R-2772-HHHH

27

72

41¼

2 bay, 4 hinged doors

7324

7591

342

CC0R-2784-HHHH

27

84

41¼

2 bay, 4 hinged doors

7656

7956

368

CC0R-2796-HHHHHH

27

96

41¼

3 bay, 6 hinged doors

9120

9455

414

1 adjustable shelf behind each
 pair of hinged doors

LE includes 2½”h chrome base & enhanced chrome access hardware

Refer to separate CCN Charisma pricelist for complete line of matching tables, casegoods etc.

SOLON

Solon is a transitional product design that incorporates the traditional format of top over a supporting pedestal, set on a mitered plinth base with simple edge detail. The tops are 2" thick with a double ¼" radius on the top and bottom of the solid hardwood edge. These edges are mitered in all corners. Where return and bridge tops join desk and credenza worksurfaces, the edge is interrupted and continued with an inside mitered connection. This allows a smooth transition between worksurfaces. The side panels of each unit have the same double ¼" radius detail on the vertical edges. The 2" high plinth base projects ½" with the double ¼" radius shape on the top corner. The approach side of the desk has a stepped modesty panel in keeping with the traditional format. Backs of credenzas are flush, finished and do not include the base detail. Drawer access is accomplished with a recessed and radiused campaign-style pull. Doors are opened with a single round knob, except where bottom edge access is available, (ie: Hi-Rise Storage.) Both pieces of hardware are standard as bright brass. Black locks are standard on all drawers and are keyed alike by set-up.

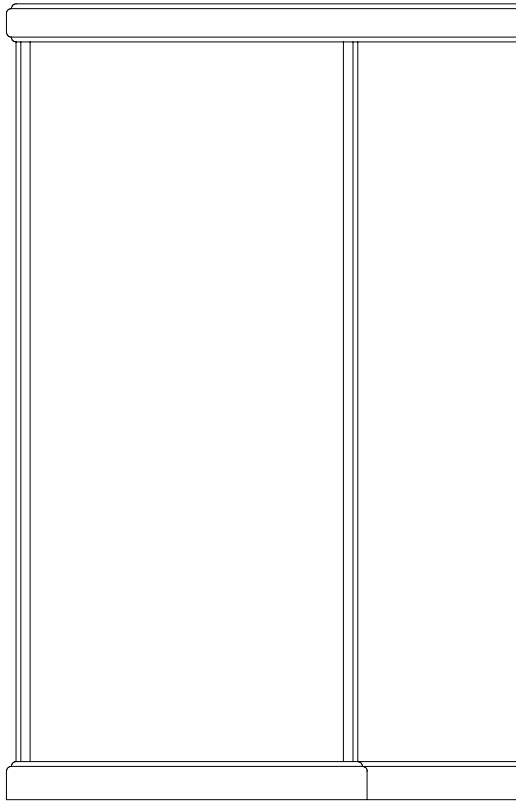

This price list allows a certain amount of flexibility with the drawer storage components. The box/box/file pedestals (6-6-12) indicated with the letters A or C and the file/file (12-12) indicated with the letters B or D are interchangeable. Within the model number, the letters after the dimensional numbers communicate the drawer configuration. These letters indicate the sequence and type of drawer storage on the unit. The A, B, C and D pedestals are interchangeable at the same price. All configurations illustrated include one C and one D pedestal.

The overall dimensions indicated include any protrusions, overhang or thickness of detail(s). When multiple components are configured together to form large assemblies, these detail dimensions will include the elimination of conflicting or duplicated detail. Top dimensions indicated are for the net (usable) worksurface area

CONFIGURATION EXAMPLES

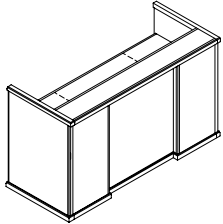
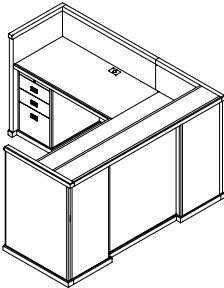
	Description	Notes	Price (US\$)	Weight (lbs.)
Gallery Desk 	SD0RT-3072-CD-GL2 overall dimension 30"D x 72"W x 42½"H Desk top: 27¼" x 68"	letter width b/b/f & f/f pedestals	8416	435
	SD0RT-3084-CD-GL2 overall dimension 30"D x 84"W x 42½"H Desk top: 27¼" x 80"	legal width b/b/f & f/f pedestals	8763	467
	SD0RT-3096-CD-GL2 overall dimension 30"D x 96"W x 42½"H Desk top: 27¼" x 92"	legal width b/b/f & f/f pedestals	9109	500
Gallery Desk w/ Return 	SGAL-7272-CD-GL3 overall dimension 72"D x 72"W x 42½"H Desk top: 27¼" x 68" Return top: 19½" x 41"	letter width b/b/f & f/f pedestals	11192	549
	SGAL-7284-CD-GL3 overall dimension 72"D x 84"W x 42½"H Desk top: 27¼" x 80" Return top: 19½" x 41"	legal width b/b/f & f/f pedestals	11539	581
	SGAL-7296-CD-GL3 overall dimension 72"D x 96"W x 42½"H Desk top: 27¼" x 92" Return top: 24½" x 41"	legal width b/b/f & f/f pedestals	12035	628
Specify Left or Right (seated)	(Left indicated)			



Above pricing reflects standard cherry and maple finishes. Consult sales representative for any variation of size, configuration, finish or wood species.

CONFIGURATION EXAMPLES

Description

Notes

Price (US\$) **Weight (lbs.)**

"U" Configuration Side Entry

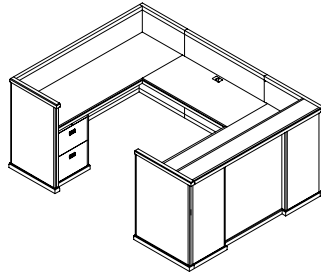

SGCL-9472-CD-GL4
 overall dimension 93½"D x 72"W x 42½"H
 Desk top: 27¼" x 68"
 Bridge top: 19½" x 44"
 Credenza top: 19½" x 68"

letter width b/b/f & f/f pedestals

14794 725

SGCL-9484-DC-GL4
 overall dimension 93½"D x 84"W x 42½"H
 Desk top: 27¼" x 80"
 Bridge top: 19½" x 44"
 Credenza top: 19½" x 80"

legal width b/b/f & f/f pedestals

15458 782

SGCL-9996-DC-GL4
 overall dimension 98½"D x 96"W x 42½"H
 Desk top: 27¼" x 92"
 Bridge top: 24½" x 44"
 Credenza top: 24½" x 92"

legal width b/b/f & f/f pedestals

16445 876

Specify **L**eft or **R**ight (seated)

(**L**eft indicated)

"U" Configuration Rear Entry

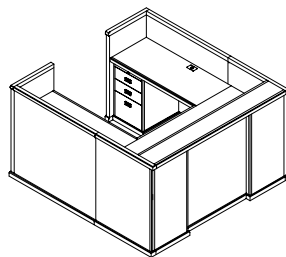

SGM-7284-CD-GL4
 overall dimension 72"D x 84"W x 42½"H
 Return top: 19½" x 41"
 Desk top: 27¼" x 80"
 Return top: 19½" x 41"

legal width b/b/f & f/f pedestals

14315 695

SGM-7296-CD-GL4
 overall dimension 72"D x 96"W x 42½"H
 Return top: 24½" x 41"
 Desk top: 27¼" x 92"
 Return top: 24½" x 41"

legal width b/b/f & f/f pedestals

14663 728

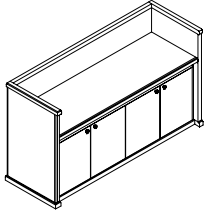
Description	Model Number	Overall Dimensions			Notes	Price (US\$)	Weight (lbs.)
		Depth	Width	Height			
Credenza Full Hinged Door Storage 	SC0R-2772-HHHH	26½	72	42½	2 bay, 4 hinged doors	7111	349
	SC0R-2784-HHHH	26½	84	42½	2 bay, 4 hinged doors	7438	376
	SC0R-2796-HHHHHH	26½	96	42½	3 bay, 6 hinged doors	8890	423

1 adjustable shelf behind each pair of hinged doors

Refer to separate CCN Solon pricelist for complete line of matching tables, casegoods etc.

ENCLAVE/NUANCE

Enclave is a 2" profile design that features a 1" quarter radius that combines with a 1" 45 degree bevel.

Nuance is a 2" profile that joins a double ¼" radius detail with a 1" 45 degree bevel. These two elements are separated by an ⅛" black rigid vinyl beaded trim.

These designs utilize a counter-profile shape on the ends of return or bridge tops when connecting to a desk or credenza top. This allows a smooth transition between worksurfaces.

Drawers are opened by recessed side finger access. The hinged doors have touch latch hardware or bottom edge access where possible. Necessary exposed black hardware is used on lateral file drawers. Locks are standard on all drawers and are keyed alike by set-up.

This price list allows a certain amount of flexibility with the drawer storage components. The box/box/file pedestals (6-6-12) indicated with the letters A or C and the file/file (12-12) indicated with the letters B or D are interchangeable. Within the model number, the letters after the dimensional numbers communicate the drawer configuration. These letters indicate the sequence and type of drawer storage on the unit. The A, B, C and D pedestals are interchangeable at the same price. All configurations illustrated include one C and one D pedestal.

The overall dimensions indicated include any protrusions, overhang or thickness of detail(s). When multiple components are configured together to form large assemblies, these detail dimensions will include the elimination of conflicting or duplicated detail. Top dimensions indicated are for the net (usable) worksurface area

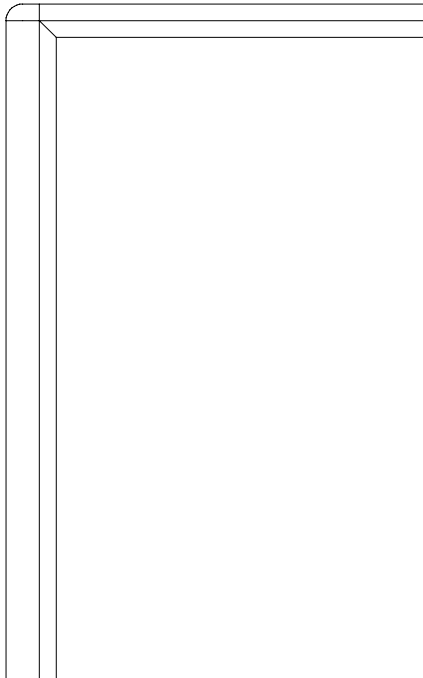

CONFIGURATION EXAMPLES

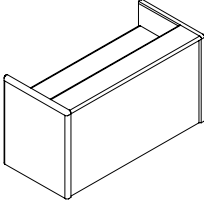
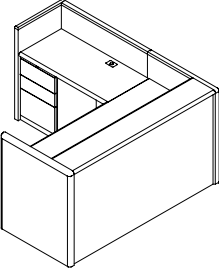
	Description	Notes	Price (US\$)	Weight (lbs.)
Gallery Desk 	_DORT-3072-AB-GL2 overall dimension 30"D x 72"W x 41½"H Desk top: 28" x 68"	legal width b/b/f & f/f pedestals	7380	373
	_DORT-3084-CD-GL2 overall dimension 30"D x 84"W x 41½"H Desk top: 28" x 80"	legal width b/b/f & f/f pedestals	7661	396
	_DORT-3096-CD-GL2 overall dimension 30"D x 96"W x 41½"H Desk top: 28" x 92"	legal width b/b/f & f/f pedestals	7941	419
Gallery Desk w/ Return 	_GAL-7272-AB-GL3 overall dimension 72"D x 72"W x 41½"H Desk top: 28" x 68" Return top: 19½" x 41"	letter width b/b/f & f/f pedestals	10072	479
	_GAL-7284-CD-GL3 overall dimension 72"D x 84"W x 41½"H Desk top: 28" x 80" Return top: 19½" x 41"	legal width b/b/f & f/f pedestals	10350	502
	_GAL-7296-CD-GL3 overall dimension 72"D x 96"W x 41½"H Desk top: 28" x 92" Return top: 24½" x 41"	legal width b/b/f & f/f pedestals	10775	537
Specify L eft or R ight (seated)	(L eft indicated)			

CONFIGURATION EXAMPLES

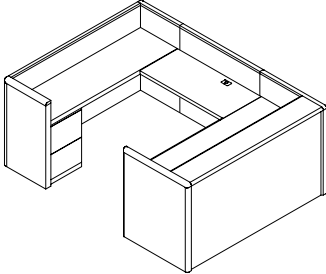
	Description	Notes	Price (US\$)	Weight (lbs.)
<p>"U" Configuration Side Entry</p> 	<p>_GCL-9472-AB-GL4 overall dimension 93½"D x 72"W x 41½"H Desk top: 28" x 68" Bridge top: 19½" x 44" Credenza top: 19½" x 68"</p>	letter width b/b/f & f/f pedestals	13512	640
	<p>_GCL-9484-DC-GL4 overall dimension 93½"D x 84"W x 41½"H Desk top: 28" x 80" Bridge top: 19½" x 44" Credenza top: 19½" x 80"</p>	legal width b/b/f & f/f pedestals	14108	686
	<p>_GCL-9996-DC-GL4 overall dimension 98½"D x 96"W x 41½"H Desk top: 28" x 92" Bridge top: 24½" x 44" Credenza top: 24½" x 92"</p>	legal width b/b/f & f/f pedestals	15013	763

Specify **Left** or **Right** (seated) (**L**eft indicated)

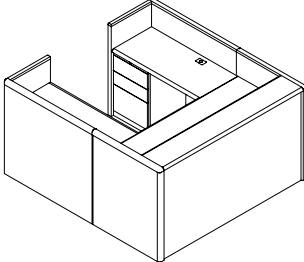
<p>"U" Configuration Rear Entry</p> 	<p>_GM-7284-CD-GL4 overall dimension 72"D x 84"W x 41½"H Return top: 19½" x 41" Desk top: 28" x 80" Return top: 19½" x 41"</p>	legal width b/b/f & f/f pedestals	13039	608
	<p>_GM-7296-CD-GL4 overall dimension 72"D x 96"W x 41½"H Return top: 24½" x 41" Desk top: 28" x 92" Return top: 24½" x 41"</p>	legal width b/b/f & f/f pedestals	13322	631

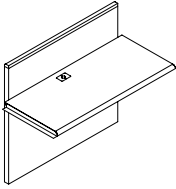
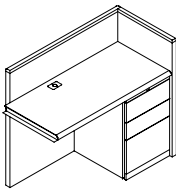
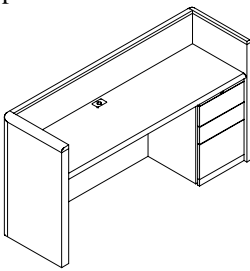
Description	Model Number	Overall Dimensions			Note	Price (US\$)	Weight (lbs.)
		Depth	Width	Height			
	_B0R-2242-0-GL1	21½	44	41½		2011	78
	_B0R-2248-0-GL1	21½	50	41½		2167	90
	_B0R-2254-0-GL1	21½	56	41½		2326	101
	_B0R-2742-0-GL1	26½	44	41½		2100	84
	_B0R-2748-0-GL1	26½	50	41½		2259	96
	_B0R-2754-0-GL1	26½	56	41½		2417	108
	_R0R-2242-AR-GL1	21½	43	41½	letter width b/b/f pedestal	4045	186
	_R0R-2248-AR-GL1	21½	49	41½	legal width b/b/f pedestal	4201	197
	_R0R-2254-AR-GL1	21½	55	41½	legal width b/b/f pedestal	4361	208
	_R0R-2742-AR-GL1	26½	43	41½	letter width b/b/f pedestal	4190	198
	_R0R-2748-AR-GL1	26½	49	41½	legal width b/b/f pedestal	4348	210
	_R0R-2754-AR-GL1	26½	55	41½	legal width b/b/f pedestal	4508	222
Specify Left or Right (seated)	(Right indicated)						
	_C0R-2272-AR-GL1	21½	72	41½	letter width b/b/f pedestal right	5474	269
	_C0R-2284-AR-GL1	21½	84	41½	legal width b/b/f pedestal right	5792	292
	_C0R-2296-CR-GL1	21½	96	41½	legal width b/b/f pedestal right	6104	314
	_C0R-2772-AR-GL1	26½	72	41½	letter width b/b/f pedestal right	5687	292
	_C0R-2784-AR-GL1	26½	84	41½	legal width b/b/f pedestal right	6009	316
	_C0R-2796-CR-GL1	26½	96	41½	legal width b/b/f pedestal right	6328	340
Specify Left or Right (seated)	(Right indicated)						

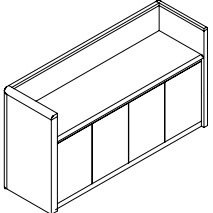
Description	Model Number	Overall Dimensions			Notes	Price (US\$)	Weight (lbs.)
		Depth	Width	Height			
Credenza- Full Hinged Door Storage 	_COR-2772-HHHH	26½	72	41½	2 bay, 4 hinged doors	6638	332
	_COR-2784-HHHH	26½	84	41½	2 bay, 4 hinged doors	6956	356
	_COR-2796-HHHHHH	26½	96	41½	3 bay, 6 hinged doors	8291	400

1 adjustable shelf behind each pair of hinged doors

Refer to separate CCN Enclave/Nuance pricelist for complete line of matching tables, casegoods, etc.

FOUNDATION

Foundation reception desks consist of a 41¼" high Gallery workstation capped by a 1½" high transaction surface (total height = 42¾"). Simple square edged detailing is employed throughout except for the visitor side edge of the transaction surface which may be specified as **a** (bevel), **g** (ogee), **m** (reeded), **q** (square), **r** (bullnose), or **s** (step radius).

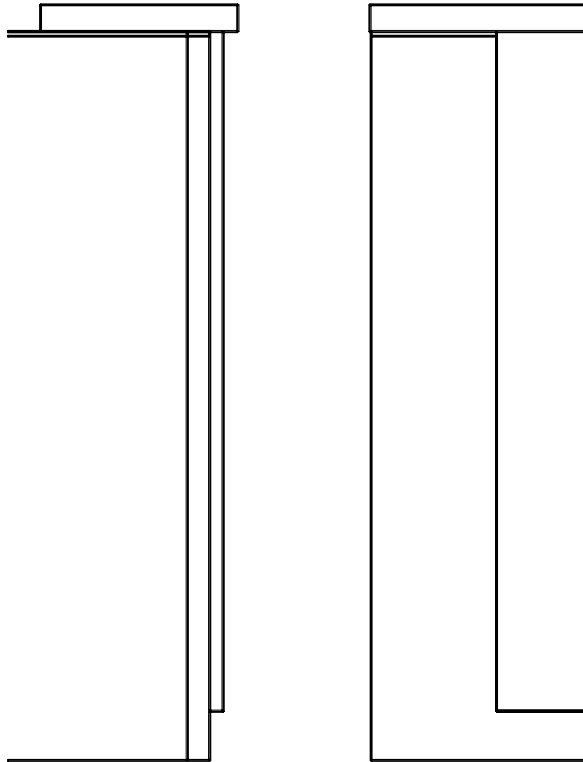

Any of six hardware styles may be specified. These include: **1** a square section loop pull, **2** a semi-traditional loop pull, **3** a double ribbed loop pull, **4** a flat bar pull with radiused ends, **5** a tapered loop pull, or **6** a curvilinear pull. Several different finishes are available on each. Please refer to the Foundation pricelist and literature for further information on edge profile and hardware.

Options include a transaction surface with a bow contour on the approach side and/or Applied Feature Fronts. Five options are offered for Feature Fronts, including plain vertical grain maple or cherry, vertical grain cherry or maple ¼" x ¼" black horizontal reveals, reverse box pattern birdseye maple, chevron pattern sycamore or anigre, or contrast square inlay.

This price list allows a certain amount of flexibility with the drawer storage components. The box/box/file pedestals (6-6-12) indicated with the letters A or C and the file/file (12-12) indicated with the letters B or D are interchangeable. Within the model number, the letters after the dimensional numbers communicate the drawer configuration. These letters indicate the sequence and type of drawer storage on the unit. The A, B, C and D pedestals are interchangeable at the same price. All configurations illustrated include one C and one D pedestal.

The overall dimensions indicated include any protrusions, overhang or thickness of detail(s). When multiple components are configured together to form large assemblies, these detail dimensions will include the elimination of conflicting or duplicated detail. Top dimensions indicated are for the net (usable) worksurface area

Grommets are standard on all gallery workstation components. Foundation gallery workstations may be integrated with other Foundation products. Please refer to the Foundation pricelist for further information

CONFIGURATION EXAMPLES

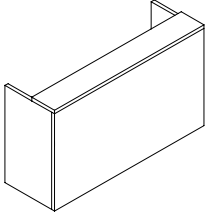
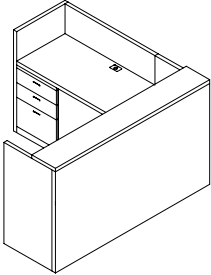
	Description	Notes	Price (US\$)	Weight (lbs.)
Gallery Desk 	_DORT-3072-AB-GL2 overall dimension 30"D x 72"W x 42¾"H Desk top: 28½" x 69"	letter width b/b/f & f/f pedestals	6291	451
	_DORT-3084-CD-GL2 overall dimension 30"D x 84"W x 42¾"H Desk top: 28½" x 81"	legal width b/b/f & f/f pedestals	6567	485
	_DORT-3096-CD-GL2 overall dimension 30"D x 96"W x 42¾"H Desk top: 28½" x 93"	legal width b/b/f & f/f pedestals	6847	519
Gallery Desk w/ Return 	_GAL-7272-AB-GL3 overall dimension 72"D x 72"W x 42¾"H Desk top: 28½" x 69" Return top: 18½" x 40½"	letter width b/b/f & f/f pedestals	8094	568
	_GAL-7284-CD-GL3 overall dimension 72"D x 84"W x 42¾"H Desk top: 28½" x 81" Return top: 22½" x 40½"	legal width b/b/f & f/f pedestals	8516	614
	_GAL-7296-CD-GL3 overall dimension 72"D x 96"W x 42¾"H Desk top: 28½" x 93" Return top: 28½" x 40½"	legal width b/b/f & f/f pedestals	8984	665
Specify L eft or R ight (seated)	(L eft indicated)			

CONFIGURATION EXAMPLES

Description

Notes

**Price
(US\$)** **Weight
(lbs.)**

"U" Configuration Side Entry

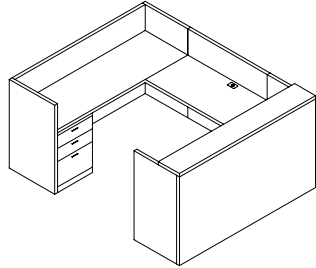

_GCL-9672-AB-GL4
overall dimension 96"D x 72"W x 42¾"H
Desk top: 28½" x 69"
Bridge top: 18½" x 40½"
Credenza top: 22½" x 69"

letter width b/b/f & f/f pedestals

10782 771

_GCL-9684-DC-GL4
overall dimension 96"D x 84"W x 42¾"H
Desk top: 28½" x 81"
Bridge top: 22½" x 40½"
Credenza top: 22½" x 81"

legal width b/b/f & f/f pedestals

11360 838

_GCL-10296-DC-GL4
overall dimension 102"D x 96"W x 42¾"H
Desk top: 28½" x 93"
Bridge top: 28½" x 40½"
Credenza top: 28½" x 93"

legal width b/b/f & f/f pedestals

12244 945

Specify **L**eft or **R**ight (seated)

(**L**eft indicated)

"U" Configuration Rear Entry

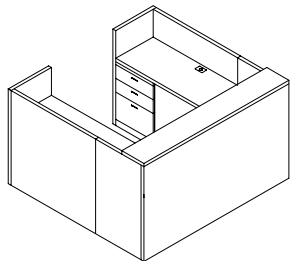

_GM-7284-CD-GL4
overall dimension 72"D x 84"W x 42¾"H
Return top: 22½" x 40½"
Desk top: 28½" x 81"
Return top: 22½" x 40½"

legal width b/b/f & f/f pedestals*

10468 743

_GM-7296-CD-GL4
overall dimension 72"D x 96"W x 42¾"H
Return top: 28½" x 40½"
Desk top: 28½" x 93"
Return top: 28½" x 40½"

legal width b/b/f & f/f pedestals

11121 811

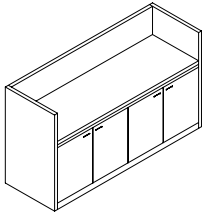
Description	Model Number	Overall Dimensions			Notes	Price (US\$)	Weight (lbs.)
		Depth	Width	Height			
Credenza Full Hinged Door Storage 	_COR-2472-HHHH	24	72	41¼	2 bay, 4 hinged doors	5071	351
	_COR-2484-HHHH	24	84	41¼	2 bay, 4 hinged doors	5310	378
	_COR-2496-HHHHHH	24	96	41¼	3 bay, 6 hinged doors	6396	425

1 adjustable shelf behind each pair of hinged doors

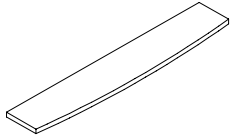
Bow Front Overlay Transaction Shelf Upgrade 	_WA11F-1472	13½	72⅞	1½	72" bowfront transaction top	70
	_WA11F-1584	14½	84⅞	1½	84" bowfront transaction top	92
	_WA11F-1696	15½	96⅞	1½	96" bowfront transaction top	115



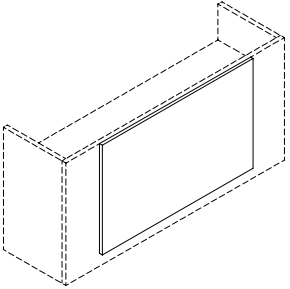
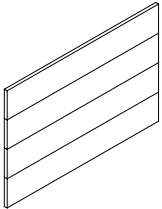
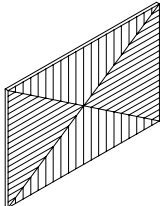

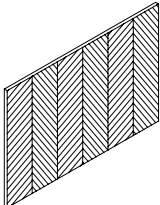
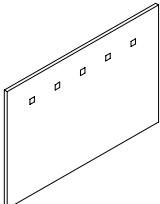
Refer to separate CCN Foundation pricelist for complete line of matching tables, casegoods, etc

Description	Model Number	Overall Dimensions			Notes	Price (US\$)	Weight (lbs.)	
		Depth	Width	Height				
Applied Feature Fronts for Foundation Gallery Desks								
I		1WFI-15838	3/4	58	38	vertical grain cherry or maple	1037	46
		1WFI-16438	3/4	64	38		1072	51
		1WFI-17038	3/4	70	38		1111	55
		1WFI-17638	3/4	76	38		1151	60
II		1WFII-15838	3/4	58	38	vertical grain cherry or maple with black 1/4" x 1/4" horizontal reveals	1450	46
		1WFII-16438	3/4	64	38		1512	51
		1WFII-17038	3/4	70	38		1572	55
		1WFII-17638	3/4	76	38		1634	60
III		1WFIII-15838	3/4	58	38	reverse box pattern birdseye maple	3195	46
		1WFIII-16438	3/4	64	38		3456	51
		1WFIII-17038	3/4	70	38		3717	55
		1WFIII-17638	3/4	76	38		3980	60

Description	Model Number	Overall Dimensions			Notes	Price (US\$)	Weight (lbs.)	
		Depth	Width	Height				
Applied Feature Fronts for Foundation Gallery Desks								
IV		1WFIV-15838	3/4	58	38	quartered figured sycamore or anigre	2008	46
		1WFIV-16438	3/4	64	38		2146	51
		1WFIV-17038	3/4	70	38		2283	55
		1WFIV-17638	3/4	76	38		2424	60
V		1WFV-15838	3/4	58	38	contrast square inlay options:	1370	46
		1WFV-16438	3/4	64	38		1442	51
		1WFV-17038	3/4	70	38		1514	55
		1WFV-17638	3/4	76	38		1590	60
options:								
* natural cherry in natural maple								
* natural maple in natural cherry								
* black in maple (any CCN standard finish)								
* black in cherry (any CCN standard finish)								

58 inch wide Feature Fronts recommended for use on 72 inch wide Gallery Desks
64 inch wide Feature Fronts recommended for use on 78 inch wide Gallery Desks
70 inch wide Feature Fronts recommended for use on 84 inch wide Gallery Desks
76 inch wide Feature Fronts recommended for use on 96 inch wide Gallery Desks

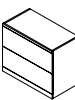
Pedestals

	Foundation	Enclave Nuance	Remaining Reception Desk Designs		
To Add:					A or B (box/box/file)
an A or C pedestal	1243	1356	1469		
a B or D pedestal	1243	1356	1469		
an E or F pedestal	1526	1450	1752		
an H pedestal	904	1017	1130		
an HH pedestal	1243	11356	1469		B or D (file/file)
To Substitute for an A, B, C or D pedestal for:					
an E or F pedestal	283	283	283		E or F (lateral file)
an H pedestal	-339	-339	-339		
an HH pedestal	n/c	n/c	n/c		
To Delete:					H (single door)
an A or C pedestal	-1243	-1356	-1469		
a B or D pedestal	-1243	-1356	-1469		
A, B, C and D pedestals are interchangeable at the same price					HH (double door)

When substituting or adding pedestals, please ensure that adequate space is available to accommodate desired pedestal configuration